

2

WALL CEILING SUSPENSION FLOOR

LE COLLEZIONI

lucifero's
ARCHI-TECH LIGHTING

INDOOR - Parete, Soffitto, Sospensione e Terra | Wall, Ceiling , Suspension & Floor

MINIFILE MIX P. 212 NEW

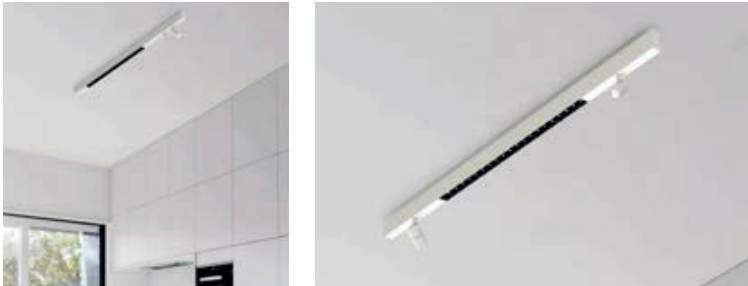

ICEMENTI P. 217



IPIEDIQ P. 225

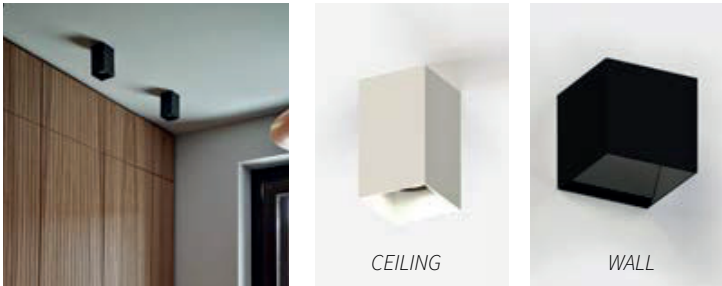

IPIEDI P. 231 NEW



IBRIDA P. 243 NEW

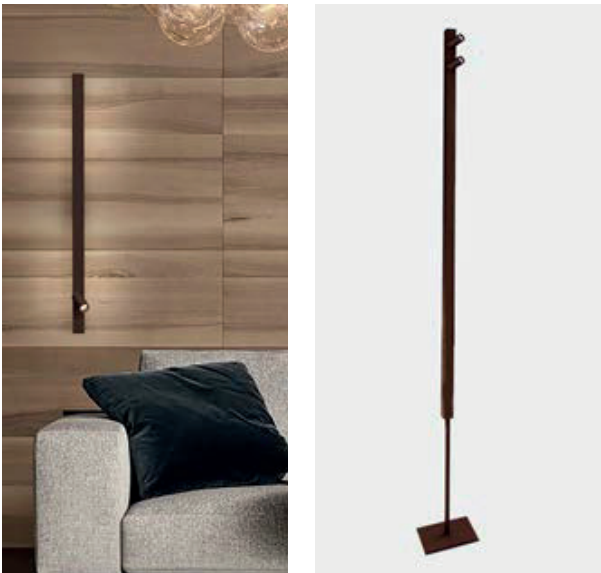

AURA IN P. 259 NEW



LEVA P. 263



FILE 2 COMPLEMENTI P. 269



INDOOR - Parete, Soffitto, Sospensione e Terra | Wall, Ceiling , Suspension & Floor

MANINE P. 273 NEW



APP P. 281



MINIFILE MIX



Apparecchi in estruso di alluminio 62x32mm, per installazione a soffitto e sospensione con sorgenti lineari led, a luce diffusa, moduli con microottiche a luminanza controllata antiabbagliamento e spot focus Ø 36 mm, completi di alimentatori elettronici 230/240V. Finitura verniciata o anodizzata. Schermi diffondenti in policarbonato opalino, testate di chiusura laterali con sistema Light Proof. Grado di protezione IP20.

Extruded aluminum profiles 62x32mm, for ceiling and suspension installation with linear LED sources, diffused light, modules with microoptics with controlled anti-glare luminance and spot focus Ø 36 mm, complete with electronic power supply 230/240V. Painted or anodized finish. Diffuser screens in opaline polycarbonate and side closing heads with Light Proof system. Degree of protection IP20.



UK CONFORMITY ASSESSMENT E EUROPEAN CERTIFICATION / UK CONFORMITY ASSESSMENT AND EUROPEAN CERTIFICATION



PRODOTTI COSTRUITI CON MATERIALE RICICLABILE / PRODUCTS MADE OF RECYCLABLE MATERIAL



GARANZIA DI 5 ANNI / 5-YEAR WARRANTY



MONO EMISSIONE O BI EMISSIONE / MONO EMISSION OR DOUBLE EMISSION



ACCENSIONI SEPARATE | SEPARATE IGNITION

Le versioni a luce diretta ed indiretta sono sempre predisposte per accensioni separate | Direct and indirect version are always prepared for independent ignition

KELVIN

27		2700°K
30		3000°K
35		3500°K
40		4000°K

FASCIO / BEAM

F		FLOOD
W		WIDE

FINITURE / FINISHINGS

/01		TELAIO BIANCO OTTICA NERA / WHITE FRAME BLACK OPTIC
/02		TELAIO NERO OTTICA NERA / BLACK FRAME BLACK OPTIC
/41		TELAIO BIANCO OTTICA BIANCA / WHITE FRAME WHITE OPTIC
/42		TELAIO NERO OTTICA ORO / BLACK FRAME GOLD OPTIC

FINITURE PREMIUM / PREMIUM FINISHINGS

	81-ORO ROSA / PINK GOLD		82-BRONZO ANTICATO/ANTIQUE BRONZE		83-OTTONE SATINATO/ BRUSHED BRASS
--	-------------------------	--	-----------------------------------	--	-----------------------------------

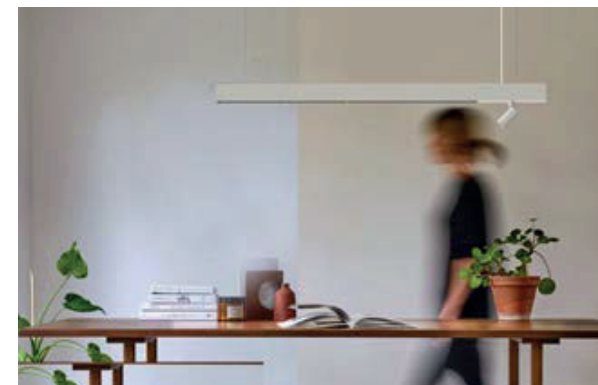

CURVE FOTOMETRICHE/PHOTOMETRIC DATA

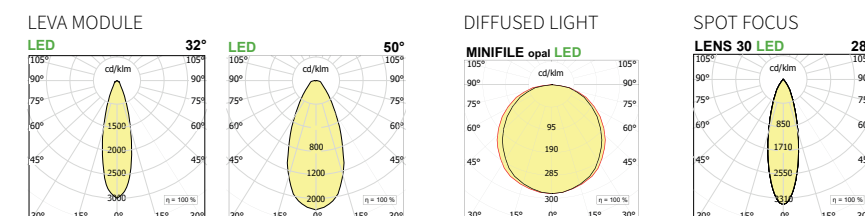

MINIFILE MIX SOSPENSIONE SUSPENSION



LUCE DIRETTA LEVA + 1 FOCUS DIRECT LIGHT

W	Lmm	Kg	ø	H	F32°	W50°	CODE
33W					2793	2484	
+ spot 1 x 8w	1140	2,20	36	92	beam F28° 695lm		MM001.9 ●●●/##

LUCE DIRETTA LEVA + 2 FOCUS DIRECT LIGHT

W	Lmm	Kg	ø	H	F32°	W50°	CODE
33W					2793	2484	
+ spots 2 x 8w	1140	2,20	36	92	beam F28° 1390 lm		MM002.9 ●●●/##

LUCE DIFFUSA + 1 FOCUS DIFFUSED LIGHT

W	Lmm	Kg	ø	H	Im product/beam 3000K	CODE
19,2W					1085	
+ spot 1 x 8w	1140	2,20	36	92	beam F28° 695lm	MM005.9 ●●●/##

LUCE DIFFUSA + 2 FOCUS DIFFUSED LIGHT

W	Lmm	Kg	ø	H	Im product/3000K	CODE
19,2					1085	
+ spots 2 x 8w	1140	2,20	36	92	beam F28° 1390 lm	MM006.9 ●●●/##

LEVA + 1 FOCUS LUCE DIRETTA-INDIRETTA DIRECT-INDIRECT LIGHT

Prodotto predisposto per accensioni separate | product prepared for independent ignition

W	Lmm	Kg	ø	H	F32°	W50°	CODE
33W					2793	2484	
direct + spot 1 x 8w	1140	2,20	36	92	beam F28° 695lm		MM003.9 ●●●/##
indirect +9,9					574		

LEVA + 2 FOCUS A LUCE DIRETTA-INDIRETTA DIRECT-INDIRECT LIGHT

Prodotto predisposto per accensioni separate | product prepared for independent ignition

W	Lmm	Kg	ø	H	F32°	W50°	CODE
33W					2793	2484	
direct + spots 2 x 8w	1140	2,20	36	92	beam F28° 1390 lm		MM004.9 ●●●/##
indirect +9,9					574		

LUCE DIFFUSA + 1 FOCUS A LUCE DIRETTA-INDIRETTA DIFFUSED LIGHT + 1 FOCUS DIRECT-INDIRECT LIGHT

W	Lmm	Kg	ø	H	Im product/beam 3000K	CODE
19,2W					1085	
direct + spot 1 x 8w	1140	2,20	36	92	beam F28° 695 lm	MM007.9 ●●●/##
indirect +9,9					574	

LUCE DIFFUSA + 2 FOCUS A LUCE DIRETTA-INDIRETTA DIFFUSED LIGHT + 2 FOCUS DIRECT-INDIRECT LIGHT

W	Lmm	Kg	ø	H	Im product/3000K	CODE
19,2					1085	
direct + spots 2 x 8w	1140	2,20	36	92	beam F28° 1390 lm	MM008.9 ●●●/##
indirect +9,9					574	

MINIFILE MIX SOFFITTO CEILING



LUCE DIRETTA LEVA + 1 FOCUS DIRECT LIGHT

W	Lmm	Kg	ø	H	Im product/beam 3000K	CODE
33W					F32° 2793 W50° 2484	
+ spot 1 x 8w	1140	2,20	36	92	beam F28° 695 lm	MM011.9 ●●●/##

LUCE DIRETTA LEVA + 2 FOCUS DIRECT LIGHT

W	Lmm	Kg	ø	H	Im product/beam 3000K	CODE
33W					2793 2484	
+ spots 2 x 8w	1140	2,20	36	92	beam F28° 1390 lm	MM012.9 ●●●/##

LUCE DIFFUSA + 1 FOCUS DIFFUSED LIGHT

W	Lmm	Kg	ø	H	Im product/beam 3000K	CODE
19,2W					1085	
+ spot 1 x 8w	1140	2,20	36	92	beam F28° 695 lm	MM015.9 ●●●/##

LUCE DIFFUSA + 2 FOCUS DIFFUSED LIGHT

W	Lmm	Kg	ø	H	Im product/3000K	CODE
19,2					1085	
+ spots 2 x 8w	1140	2,20	36	92	beam F28° 1390 lm	MM016.9 ●●●/##

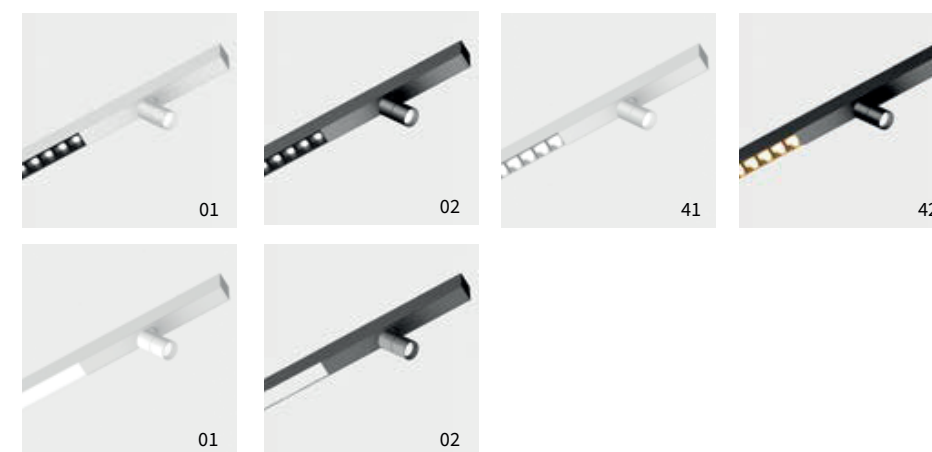

VERSIONI DISPONIBILI/AVAILABLE VERSION

- KELVIN**
 - 27 2700K
 - 30 3000K
 - 35 3500K
 - 40 4000K
- FASCIO / BEAM**
 - S Spot
 - F Flood
 - W Wide
- DIMMABLE**
 - D Dali Touch & Dimm

Per i gradi vedere in tabella - For degree check the table

/## FINITURA/FINISHING

- /01 bianco | white
- /02 nero | black
- /41 telaio bianco, ottica bianca | white frame, white optic
- /42 telaio nero, ottica oro | black frame, gold optic
- /## FINITURA PREMIUM /PREMIUM FINISHING**
 - /81 oro rosa/rose gold
 - /82 bronzo anticato/antique bronze
 - /83 ottone brunito spazzolato/brushed burnished brass

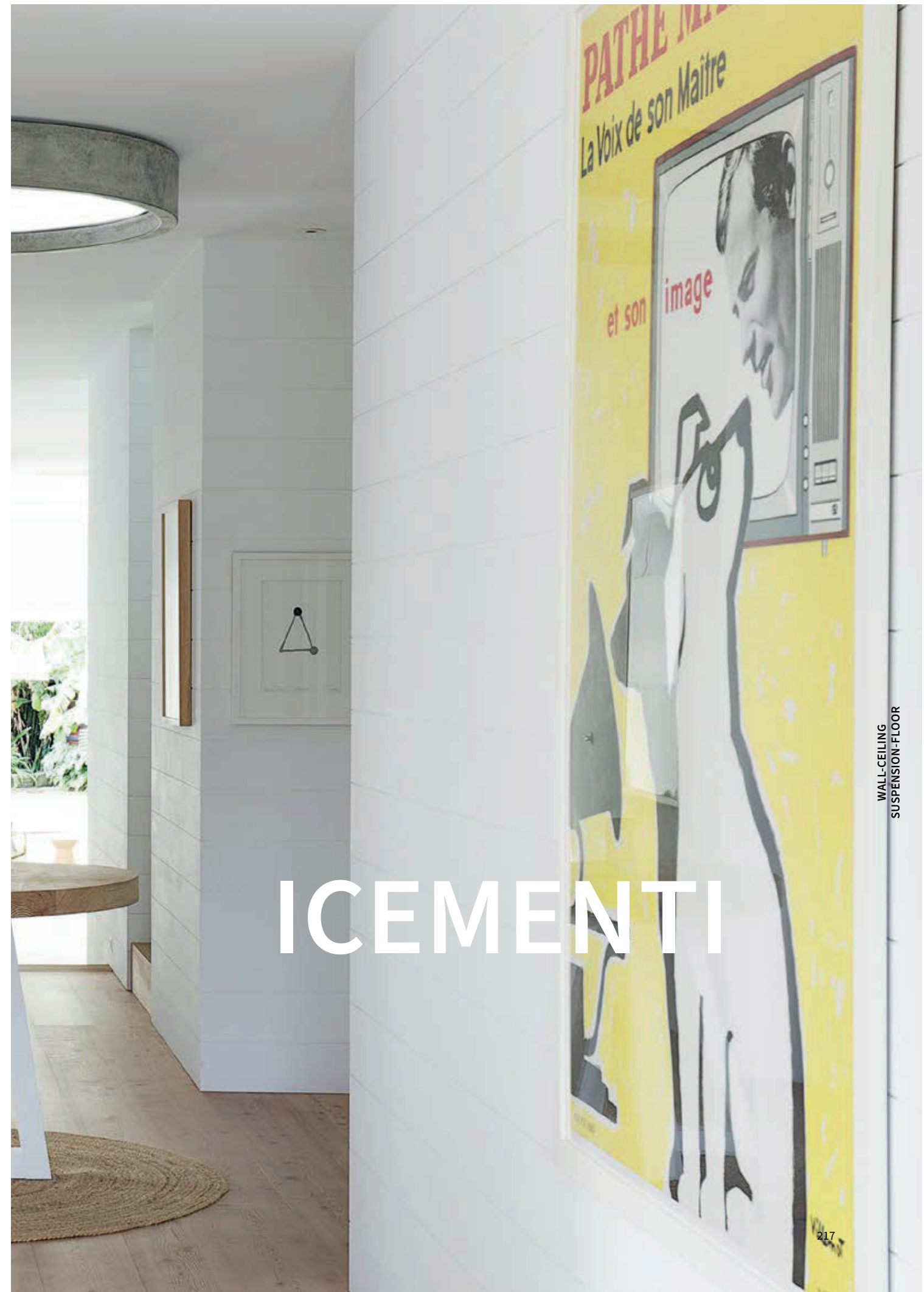

ICEMENTI



PRIVATE RESIDENCE - PERTH, AUSTRALIA
ARCHITECT: WRIGHT FELDHUSEN ARCHITECTS
LIGHTING PROJECT: GINEICO LIGHTING

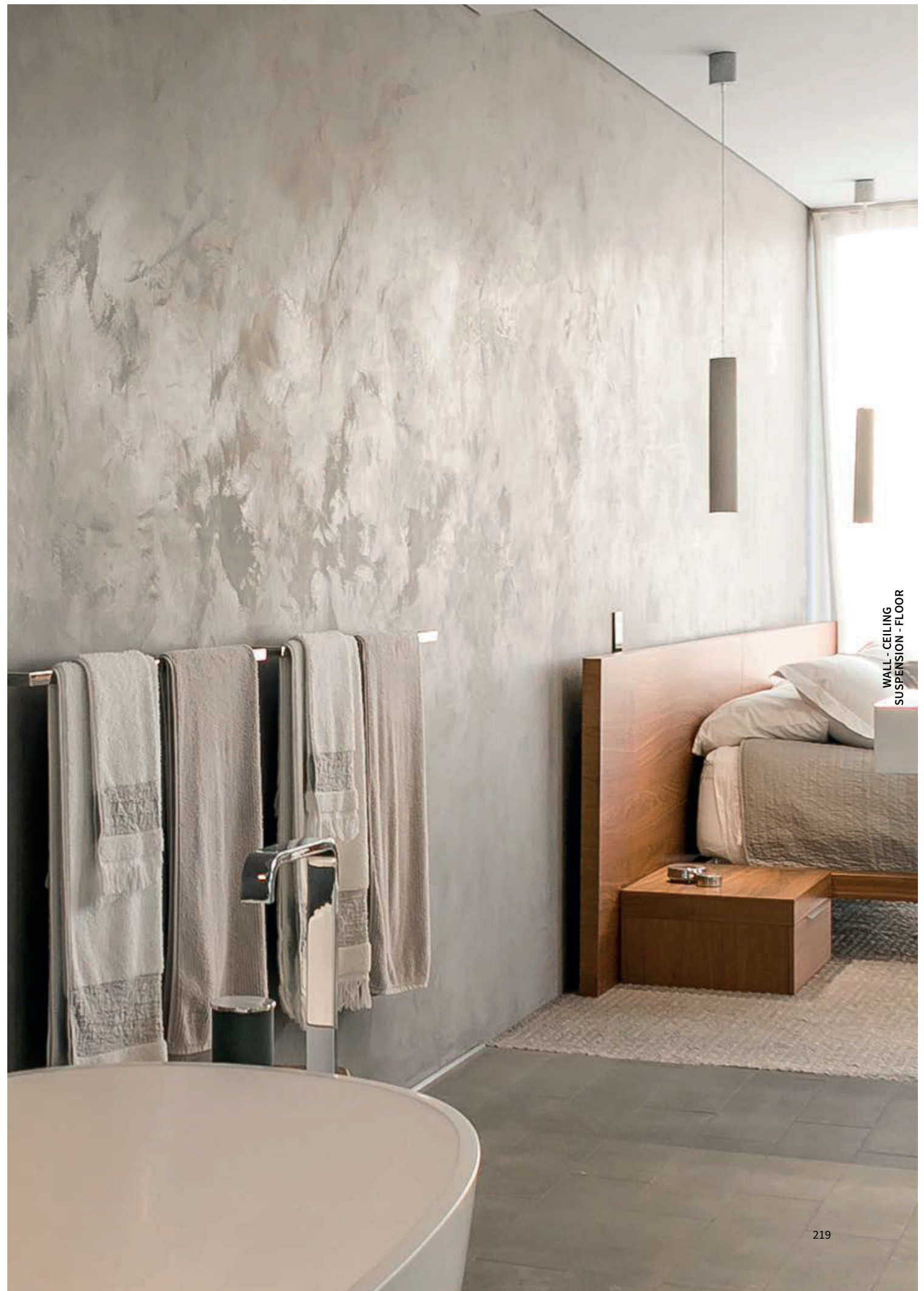

WALL - CEILING
SUSPENSION - FLOOR

ICEMENTI



051

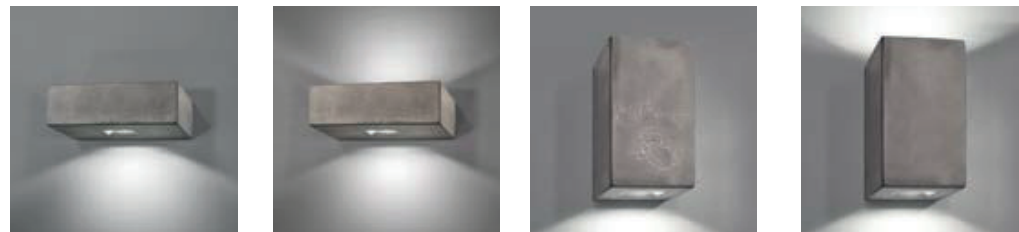

BRIQUE



2B02

2B01

altre versioni / other versions

OUTDOOR

vedi sezione "OUTDOOR" | see chapter "OUTDOOR"



PANCA



PASTORALE



CENTOTRECENTO



BRIQUE

Famiglia di apparecchi da soffitto, sospensione e parete, per illuminazione diffusa o diretta/indiretta. Completi di sorgenti LED chip on board e alimentazione elettronica integrata 50/60Hz.

Corpo in VFRC (vinilic fiber reinforced concrete) cemento fibrato alleggerito. Le versioni a luce diffusa sono dotate di schermo diffondente in PC opalino bianco (Zero51). Nelle versioni da parete il gruppo ottico è in alluminio con vetro temperato extrachiaro. Grado di protezione IP20, IP40 o IP65 a seconda dei modelli.

Family of ceiling, suspended and wall luminaires, for diffused or direct/indirect lighting. Complete with chip on board LED sources and integrated 50/60Hz electronic power supply. Body in VFRC (vinyl fiber reinforced concrete) lightweight cement fiber. The diffused light versions are equipped with a white opal PC (Zero51). In the wall versions the optical unit is in aluminum with extra-clear tempered glass. IP20, IP40 or IP65 depending on the models.



UK CONFORMITY ASSESSMENT E EUROPEAN CERTIFICATION / UK CONFORMITY ASSESSTMENT AND EUROPEAN CERTIFICATION



PRODOTTI COSTRUITI CON MATERIALE RICICLABILE / PRODUCTS MADE OF RECYCLABLE MATERIAL



GARANZIA DI 5 ANNI / 5-YEAR WARRANTY

KELVIN

27		2700°K
30		3000°K
35		3500°K
40		4000°K

CURVE FOTOMETRICHE/PHOTOMETRIC DATA

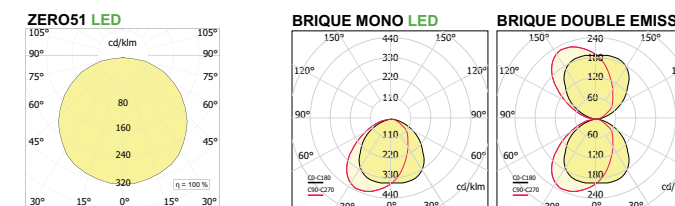

ZERO51 SOFFITTO - CEILING MOUNTED

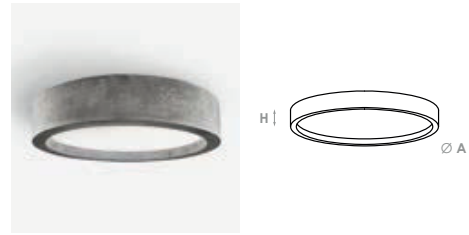

LED IP30 CRI >90 A 5 UK CE

LED						
W	Ø	H	Kg	Im prod.3000K	CODE	
45	700	150	17	3358	IC210.8	●●
96	1000	150	26	6716	IC211.8	●●
168	1300	150	40	11752	IC212.8	●●

BRIQUE O PARETE - WALL



IK08 LED IP65 CRI >90 A 5 UK CE

LED 230V						
W	Dim.	H	Kg	Im prod.3000K	CODE	
1x8	120x250	80	3	758	IC810.8	●●
2x8	120x250	80	3	1515	IC811.8	●●

80
250
120

ZERO51 SOSPENSIONE - HANGING



LED IP30 CRI >90 A 5 UK CE

LED						
W	Ø	H	Kg	Im prod.3000K	Dali	
45	700	150	18	3358	IC220.8	●●
96	1000	150	27	6716	IC221.8	●●
168	1300	150	41	11752	IC222.8	●●

BRIQUE V PARETE - WALL



IK08 LED IP65 CRI >90 A 5 UK CE

LED 230V						
W	Dim.	H	Kg	Im prod.3000K	CODE	
1x8	120x100	200	3	758	IC910.8	●●
2x8	120x100	200	3	1515	IC911.8	●●

200
120
100

2B02 SOFFITTO - CEILING

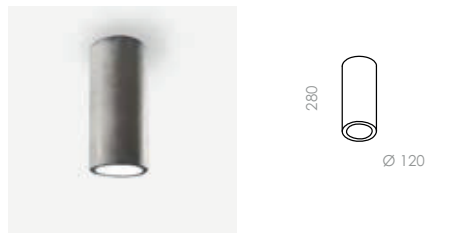

IP20 230V AC 5 UK CE

QPAR30 E27 230V					
W	Ø	H	Kg	CODE	
1 x max 100	120	280	3.10	IC1201	

Lampadina non inclusa | Lamp not included

2B02 SOSPENSIONE - HANGING



IP20 230V AC 5 UK CE

QPAR30 E27 230V					
W	Ø	H	Kg	CODE	
1 x max 100	120	280	3.5	IC1301	

Lampadina non inclusa | Lamp not included

2B01 SOSPENSIONE - HANGING

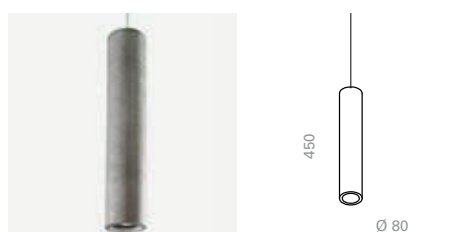

IP20 230V AC 5 UK CE

LED GU10 230V					
W	Ø	H	Kg	CODE	
1 x max 50	80	450	2.96	IC1401	

Lampadina non inclusa | Lamp not included

VERSIONI DISPONIBILI/AVAILABLE VERSION

- **KELVIN** ○ **KELVIN** ● **DIMMABLE (OPTIONAL)**
- 27 2700K 30 3000K D Dali
- 30 3000K 40 4000K
- 35 3500K
- 40 4000K

COMPOSIZIONE CODICE: xxx.x●●/##
HOW TO CREATE THE CODE: **F1000.827D/01**

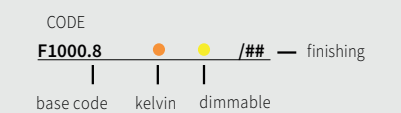

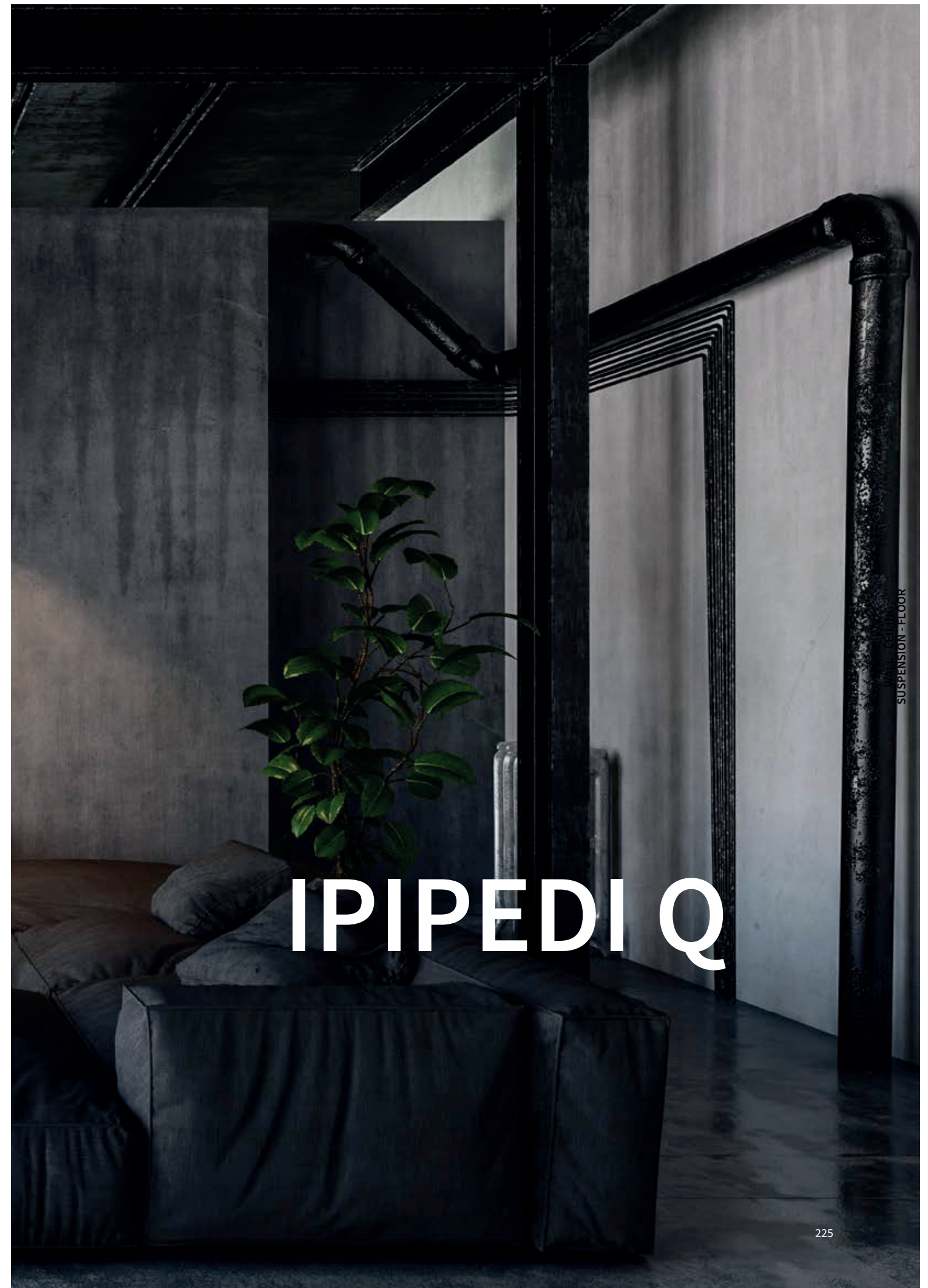

IPIPEDI Q

IPIPEDI Q

LAMPADA DA SOFFITTO - CEILING LAMP



LAMPADA DA PARETE - WALL LAMP



UK CONFORMITY ASSESSMENT E EUROPEAN CERTIFICATION / UK CONFORMITY ASSESSMENT AND EUROPEAN CERTIFICATION



PRODOTTI COSTRUITI CON MATERIALE RICICLABILE / PRODUCTS MADE OF RECYCLABLE MATERIAL



GARANZIA DI 5 ANNI / 5-YEAR WARRANTY

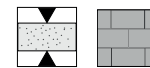

IDONEI PER CARTONGESSO OR LATERIZIO / CALCESTRUZZO a seconda dei modelli e degli accessori. SUITABLE FOR PLASTERBOARD OR BRICKWALL / CONCRETE it depends on the model and its accessories.



GU10

SORGENTE LED GU10 / GU10 LIGHT SOURCE

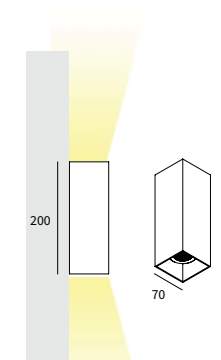
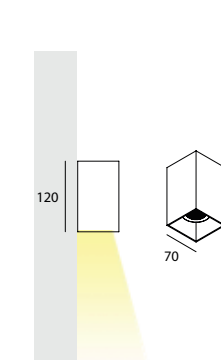
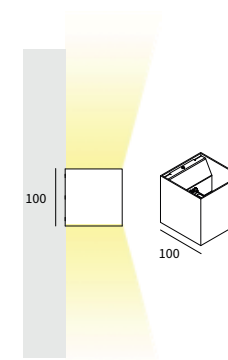

FINITURE STANDARD / STANDARD FINISHINGS

- /01 BIANCO/WHITE
- /02 NERO/BLACK
- /60 CORTEN/CORTEN
- /99 GRAFITE/GRAPHITE

FINITURE PREMIUM / PREMIUM FINISHINGS

- /81 ORO ROSA/ROSE GOLD
- /82 BRONZO ANTICATO/ ANTIQUE BRONZE
- /83 OTTONE BRUNITO SPAZZOLATO/ BRUSHED BURNISHED BRASS

Apparecchi a soffitto o parete per illuminazione diretta o diretta /indiretta, per sorgenti a tensione di rete LED con attacco GU10 o G9. Corpo a sezione quadrata in estruso di alluminio in finitura verniciata. Completi di staffa per fissaggio a soffitto o parete a seconda del modello. Grado di protezione IP20 e classe I.

Ceiling or wall mounted luminaires for direct or direct/indirect lighting, for LED mains voltage sources with GU10 or G9 socket. Square section body in extruded aluminum in painted finish. Complete with bracket for ceiling or wall mounting depending on the model. IP20 and class I.

CURVE FOTOMETRICHE/PHOTOMETRIC DATA

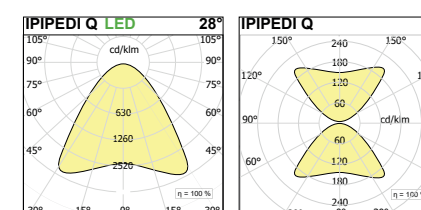



IPIPEDI Q SOFFITTO - CEILING
GU10 SOFFITTO CEILING

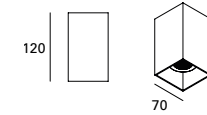
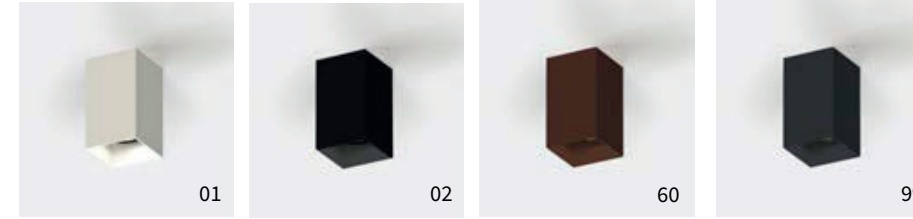

GU10LED Dim. H CODE
W 50 70x70 120 **PPQ20/##**

IPIPEDI Q PARETE - WALL

GU10 PARETE MONOEMISSIONE WALL - MOUNTED MONOEMISSION

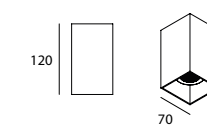

GU10LED Dim. H CODE
W 50 70x70 120 **PPQ11/##**

GU10 PARETE BIEMISSIONE WALL - MOUNTED DOUBLE EMISSION

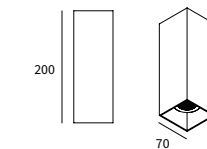

GU10LED Dim. H CODE
W 2x50 70x70 200 **PPQ12/##**

G9 BIEMISSIONE PARETE WALL - MOUNTED DOUBLE EMISSION

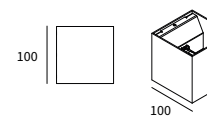
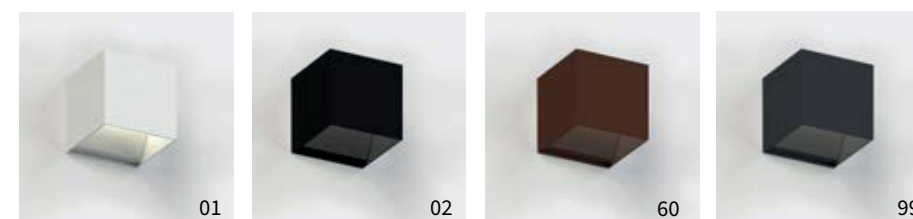

G9 230V Dim. H CODE
W 1 X max 60 100x100 100 **PPQ10/##**

VERSIONI DISPONIBILI/AVAILABLE VERSION

- /## FINITURA/FINISHING** (PREMIUM AVAILABLE)
- /01 bianco/white
 - /02 nero/black
 - /60 corten / corten
 - /99 grafite/graphite

COMPOSIZIONE CODICE: xxx.x /##

HOW TO CREATE THE CODE: **F1000/01**

CODE

F1000 /## — finishing

|
base code

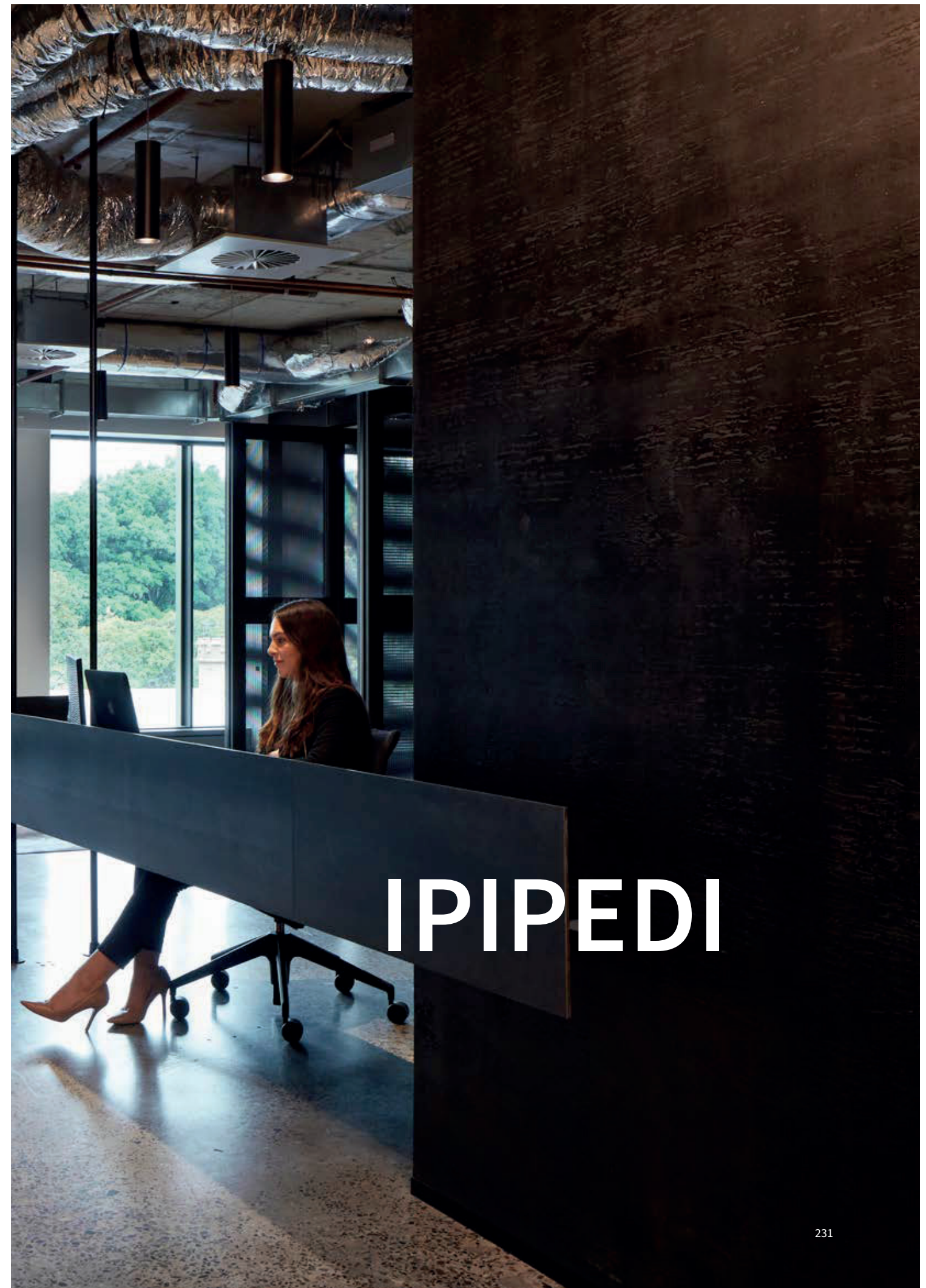

IPIPEDI

IPIPEDI

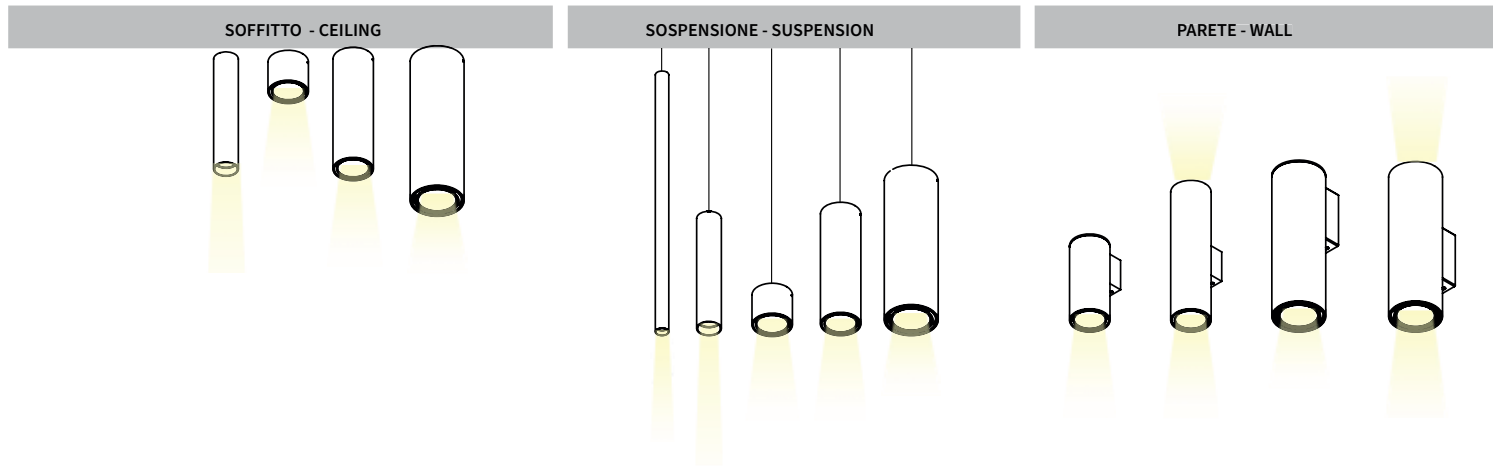

LENTI ACCESSORIE CON ANELLO / ACCESSORIES LENSES WITH RING



Apparecchi a soffitto, sospensione e parete e per binario MiniTrack 24/48V per illuminazione diretta o diretta/indiretta, completi di sorgenti LED professionali o per lampade LED GU10 230V. Completati di gruppo di alimentazione. Corpo cilindrico in estruso di alluminio finitura verniciata. Completati di staffa per fissaggio a soffitto, cavi di sospensione in acciaio con sistema di regolazione micrometrica e cavo di alimentazione L.2000 mm. o basetta di fissaggio a parete a seconda dei modelli. Grado di protezione IP20.

Ceiling, suspended or wall luminaires, available suspension for Mini Track 24/48V for direct or direct/indirect lighting, complete with professional LED sources or GU10 230V LED bulbs. Integrated power supply unit. Cylindrical body in extruded aluminum with painted finish. Complete with ceiling mounting brackets, steel suspension cables with micrometric adjustment system and power cable L.2000 mm. or wall fixing base according to the models. IP20.



UK CONFORMITY ASSESSMENT E EUROPEAN CERTIFICATION / UK CONFORMITY ASSESSMENT AND EUROPEAN CERTIFICATION



PRODOTTI COSTRUITI CON MATERIALE RICICLABILE / PRODUCTS MADE OF RECYCLABLE MATERIAL



GARANZIA DI 5 ANNI / 5-YEAR WARRANTY



VERSIONI CON SORGENTE LED GU10 DISPONIBILI / AVAILABLE GU10 LIGHT SOURCE VERSION

KELVIN	
27	2700°K
30	3000°K
35	3500°K
40	4000°K

FASCIO/BEAM

S		SPOT
F		FLOOD
W		WIDE

FINITURE STANDARD / STANDARD FINISHINGS

/01		BIANCO/WHITE
/02		NERO/BLACK
/60		CORTEN/CORTEN
/99		GRAFITE/GRAPHITE

FINITURE PREMIUM / PREMIUM FINISHINGS

/81		ORO ROSA/ROSE GOLD
/82		BRONZO ANTICATO / ANTIQUE BRONZE
/83		OTTONE BRUNITO SPAZZOLATO / BRUSHED BURNISHED BRASS

CURVE FOTOMETRICHE / PHOTOMETRIC DATA

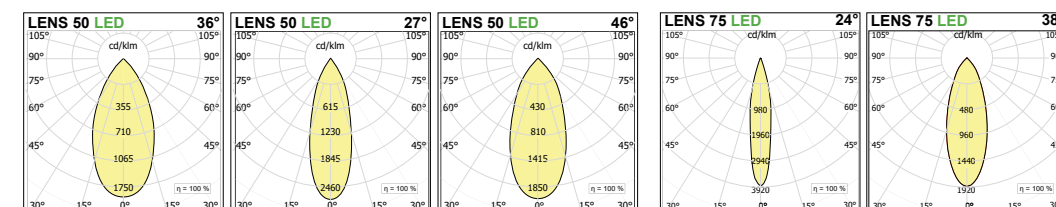

iPipedi

Sospensione | Suspension
Ø30

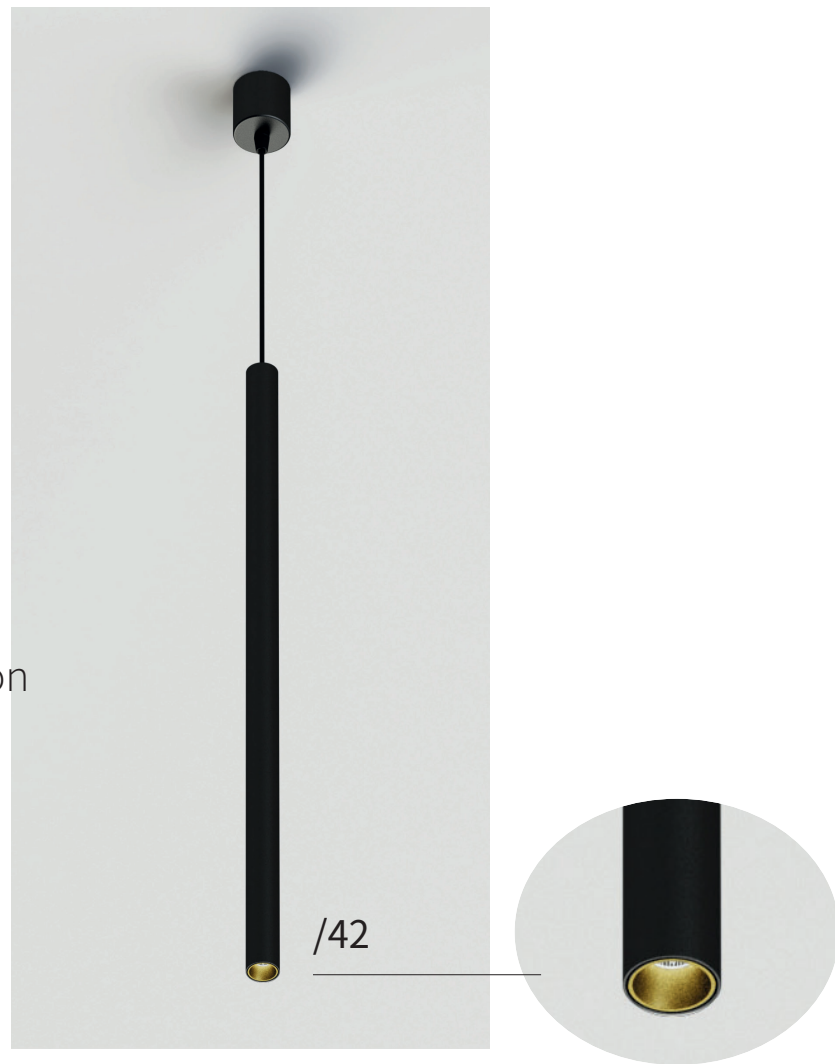

Con il suo design sottile e lungo, caratterizzato da una forma cilindrica raffinata, iPipedi Ø 30 a sospensione è pensato per creare una luce d'accento sofisticata racchiusa in soli 30 mm di diametro, perfetta per illuminare con stile ogni spazio. Con la sua versatilità, si adatta magnificamente a diverse situazioni, aggiungendo un tocco di contemporaneità e raffinatezza.

With its slim, long design, characterized by a refined cylindrical shape, the suspension iPipedi Ø 30 is designed to create a sophisticated accent light enclosed in just 30 mm in diameter, perfect for lighting up any space with style. With its versatility, it adapts beautifully to different situations, adding a touch of contemporaneity and sophistication



Ø30

IPIPEDI R30S SOSPENSIONE | SUSPENSION

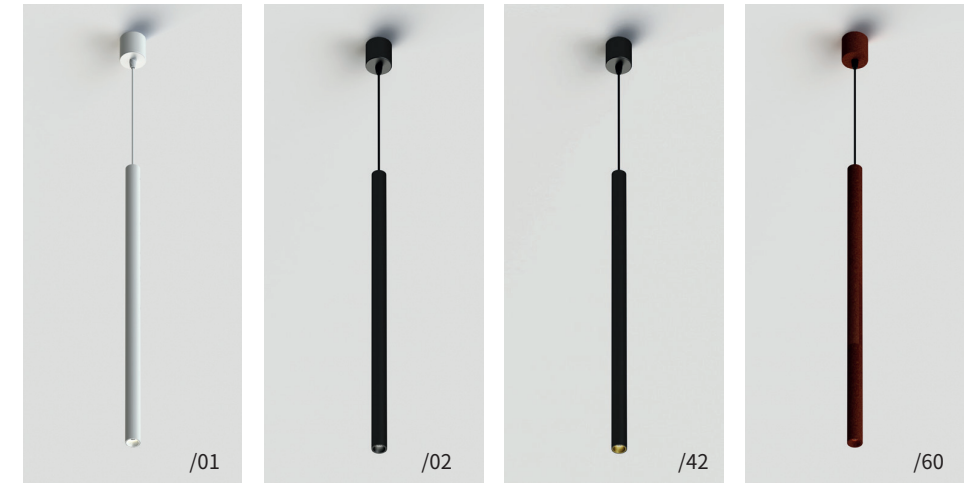
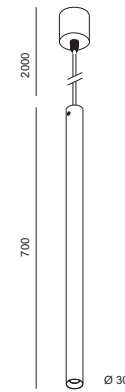

LED				lm product/beam 3000K		
W	mA	Ø	H	S16°	F30°	CODE
1,5	150	30	700	252	136	PP001.9 ●●● /##
8	700	30	700	695	720	

ACCESSORI OPTIONAL / OPTIONAL ACCESSORIES

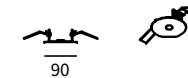

PIATTELLO PER INSTALLAZIONE A CARTONGESSO |
PLATE FOR INSTALLATION IN PLASTERBOARD



Ø	CODE
90	PP00P/##

● KELVIN

- 27 2700K
- 30 3000K
- 35 3500K
- 40 4000K

● FASCIO/BEAM

- S Spot
- F Flood

Per i gradi vedere in tabella -
For degree check the table

/## FINITURA/FINISHING

- /01 bianco/white
- /02 nero/black
- /42 nero e oro / black & gold
- /60 corten /corten

PREMIUM FINISHING AVAILABLE



iPipedi

Sospensione | Suspension

Ø55 - Ø90

Ø55

IPIPEDI R55S

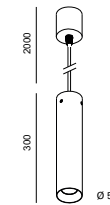

LED		Im product/beam 3000K		CODE		
W	Ø	H	Kg	F27°	W46°	
8	55	300	0,25	860	860	PP151.9
LED		Im product/beam 3000K		CODE		
W	Ø	H	Kg	F27°	W46°	
12	55	300	1,26	1289	1289	PP112.9
18	55	300	1,26	1579	1579	PP152.9
GU10 LED 230V		CODE				
W	Ø	H	Kg			
1x max 50	55	300	1,22	PP113 /##		

Ø90

I-PIPEDI R90S H300

Versione base con driver dimmerabile taglio di fase incluso | Trailing/leading edge dimmable included in Led base version.

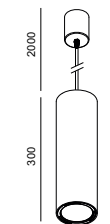

LED		Im product/beam 3000K		CODE	
W	Ø	H	Kg	F24°	W38°
17	90	300	1827	1905	PP121.9
24,3	90	300	2356	2430	PP122.9
GU10 LED 230V		CODE			
W	Ø	H	Kg	PP123 /##	
1x max 50	90	300			

Accessori - accessories: L085#.A: Anello ø85 - Lens with ring ø85

IPIPEDI R90S H90

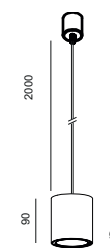

LED		Im product/beam 3000K		CODE		
W	Ø	H	Kg	F24°	W38°	
12	90	90	1,0	1289	-	PP155.9
17	90	90	1,4	1827	1905	PP156.9
24,3	90	90	1,4	2356	2430	PP157.9



KELVIN

- 27 2700K
- 30 3000K
- 35 3500K
- 40 4000K

FASCIO/BEAM

- F Flood
- W Wide

DIMMABLE (OPTIONAL)

- D Dali
- DF Dimm taglio di fase | dimm trailing /leading

/## FINITURA/FINISHING (PREMIUM AVAILABLE)

- /01 bianco/white
- /02 nero/black
- /60 corten /corten
- /99 grafite/graphite

Per i gradi vedere in tabella - For degree check the table

ACCESSORI / ACCESSORIES



LENTI CON ANELLO / LENSES WITH RING		Kg	CODE	/##
		Ø		
LENTE SATINATA / SATINED LENS		55	0,01	L055S.A
		85	0,01	L085S.A
LENTE ELLISSOIALE / ELIPSOID LENS		55	0,01	L055E.A
		85	0,01	L085E.A
LENTE ASIMMETRICA / ASYMMETRIC LENS		55	0,01	L055A.A
		85	0,01	L085A.A
FILTRO NIDO D'APE / HONEY COMB LOUVER		55	0,01	L055R.A
		85	0,01	L085R.A

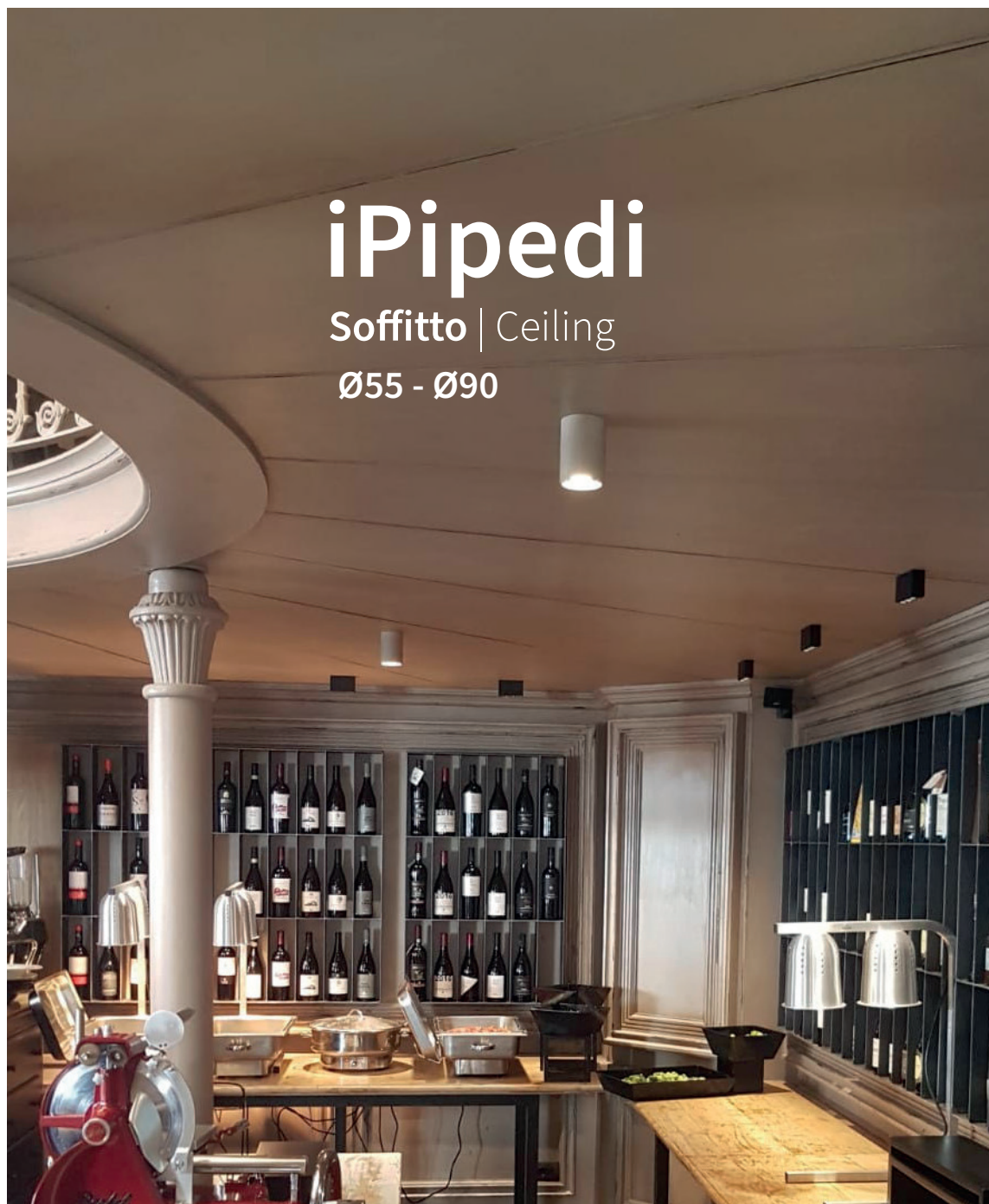

iPipedi

Soffitto | Ceiling

Ø55 - Ø90

Ø55

I-PIPEDI R55 H300

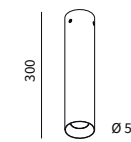

LED		Im product/beam 3000K		LED		Im product/beam 3000K		LED	
W	Ø	H	Kg	F27°	W46°	F27°	W46°	W	Ø
8	55	300	1,07	860	860	1285	1289	18	55
CODE		PP161.9		CODE		PP013.9		CODE	
		/##				/##			
GU10 LED 230V				230V		IP20		A	
W	Ø	H	Kg	CODE		PP013		/##	
1x max 50	55	300	1,04						

Ø90

I-PIPEDI R90 H90

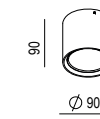

LED		Im product/beam 3000K		LED		Im product/beam 3000K		LED	
W	Ø	H	Kg	F24°	W38°	F24°	W38°	W	Ø
12	90	90	1,0	1289	-	1827	1905	24,3	90
CODE		PP165.9		CODE		PP166.9		CODE	
		/##				/##			
GU10 LED 230V				230V		IP20		A	
W	Ø <td>H</td> <td>Kg</td> <td colspan="2">CODE</td> <td colspan="2">PP167.9</td> <td colspan="2">/##</td>	H	Kg	CODE		PP167.9		/##	
1x max 50	90	90	1,4						

I-PIPEDI R90 H300

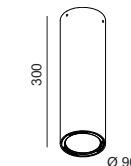

LED		Im product/beam 3000K		LED		Im product/beam 3000K		LED	
W	Ø	H	Kg	F24°	W38°	F24°	W38°	W	Ø
17	90	300	1,0	1827	1905	2356	2430	24,3	90
CODE		PP021.9		CODE		PP022.9		CODE	
		/##				/##			
GU10 LED 230V				230V		IP20		A	
W	Ø <td>H</td> <td>Kg</td> <td colspan="2">CODE</td> <td colspan="2">PP023</td> <td colspan="2">/##</td>	H	Kg	CODE		PP023		/##	
1x max 50	90	300	1,04						

Accessori - accessories: L085#.A: Anello ø85 - Lens with ring ø85

WALL - CEILING
SUSPENSION - FLOOR

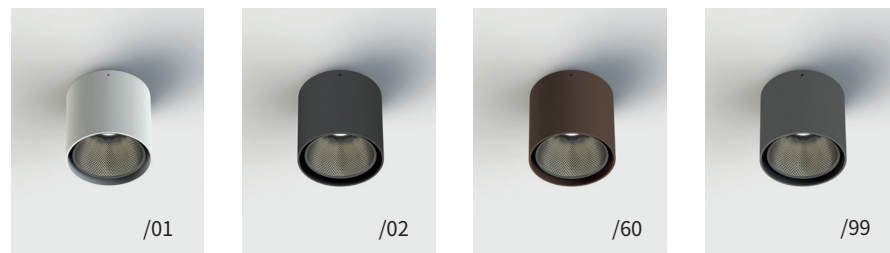

KELVIN

- 27 2700K
- 30 3000K
- 35 3500K
- 40 4000K

FASCIO/BEAM

- F Flood
- W Wide

Per i gradi vedere in tabella -
For degree check the table

DIMMABLE (OPTIONAL)

- D Dali
- DF Dimm taglio di fase |
dim trailing /leading

/## FINITURA/FINISHING (PREMIUM AVAILABLE)

- /01 bianco/white
- /02 nero/black
- /60 corten / corten
- /99 grafite/graphite

iPipedi

Parete | wall
Ø90

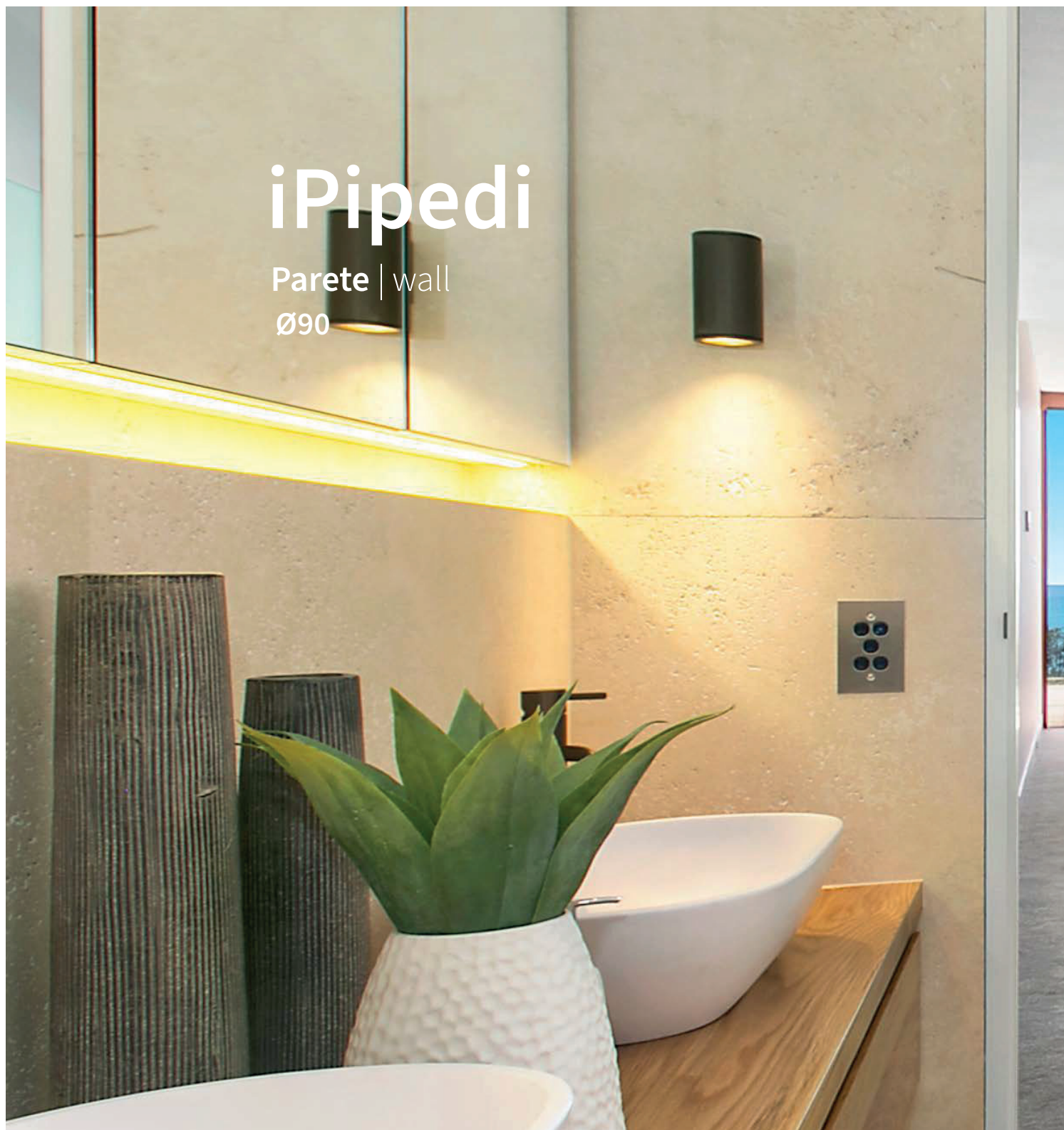

PARETE MONO EMISSIONE | SINGLE EMISSION WALL

Versione base con driver dimmerabile taglio di fase incluso | Trailing/leading edge dimmable included in Led base version.

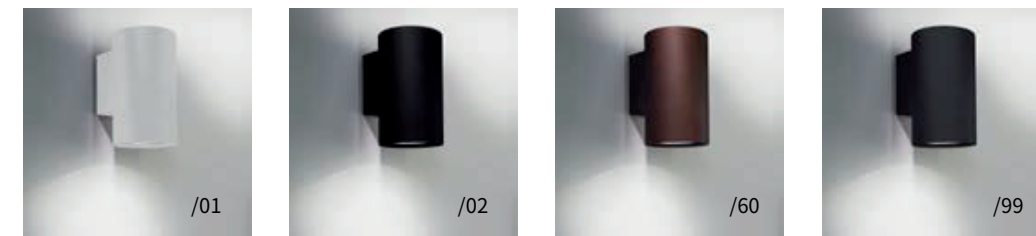

I-PIPEDI R90A H204

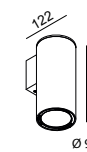

LED	W	Ø	H	lm product/beam 3000K	F24°	W38°	CODE
17	90	204	1827	1905	PP221.9 ●●●/##		

Accessori - Accessories: L085#.A: Anello ø85 + lente - Lens with rings ø85

PARETE BI EMISSIONE | DOUBLE EMISSION WALL

Versione base con driver dimmerabile taglio di fase incluso | Trailing/leading edge dimmable included in Led base version.

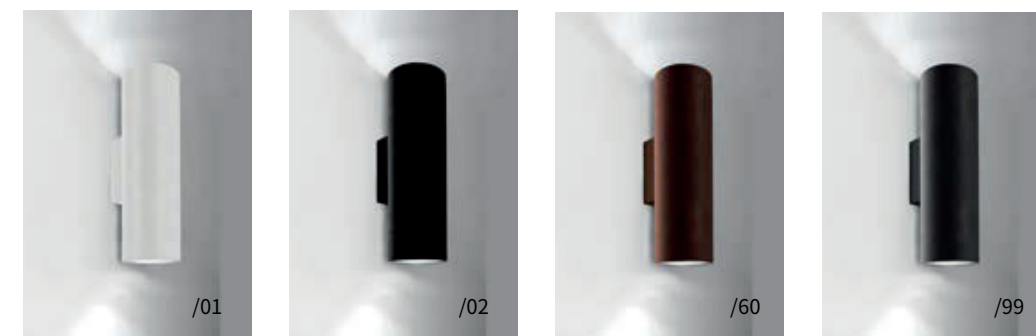

I-PIPEDI R90A2 H350

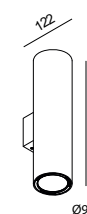

LED	W	Ø	H	lm product/beam 3000K	F24°	W38°	CODE
2x17	90	350	3654	3810	PP321.9 ●●●/##		

Accessori - Accessories: L085#.A: Anello ø85 + lente - Lens with rings ø85

WALL - CEILING
SUSPENSION - FLOOR

- **KELVIN**
- 27 2700K
- 30 3000K
- 35 3500K
- 40 4000K

- **FASCIO/BEAM**
- F** Flood
- W** Wide

Per i gradi vedere in tabella -
For degree check the table

DIMMABLE (OPTIONAL)

- **D** Dali

COMPOSIZIONE CODICE: xxx.x ●● /##

HOW TO CREATE THE CODE: **F1000.827S/01**
CODE

F1000.8 | ● | ● | — /## finishing
base code | kelvin | beam

- /## **FINITURA/FINISHING** (PREMIUM AVAILABLE)
- /01 bianco/white
- /02 nero/black
- /60 corten /corten
- /99 grafite/graphite





IBRIDA TERRA | FLOOR



/## FINITURA | FINISHING

- /01 bianco | white
- /02 nero | black
- /49 bronzo | bronze

/## FINITURA PREMIUM | PREMIUM FINISHING

- /81 oro rosa | rose gold
- /82 bronzo anticato | antique bronze
- /83 ottone brunito spazzolato/brushed burnished brass

LUCE INDIRETTA | INDIRECT LIGHT

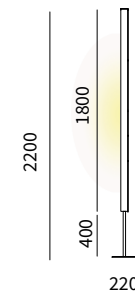

LED W	H	lm product/beam 3000K	CODE
17 indirect	2200	1590	IB000.9 ●●●/##

LUCE SPOT DIRETTA | DIRECT SPOT LIGHT

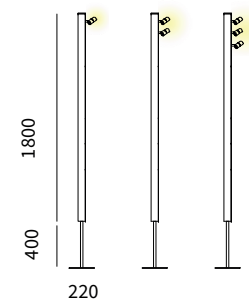

LED W	H	lm product/beam 3000K			CODE
		S19°	F28°	Z18°x38°	
8	2200	665	695	508	IB001.9 ●●●/##
16	2200	1330	1390	1016	IB002.9 ●●●/##
24	2200	1995	2085	1524	IB003.9 ●●●/##

Accessori - accessories: IB100: Modulo comandi + Command module

LUCE DIRETTA E INDIRETTA | DIRECT AND INDIRECT LIGHT

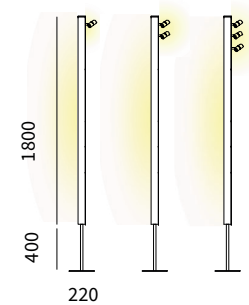

LED W	H	lm product/beam 3000K			CODE
		S19°	F28°	Z18°x38°	
17 indirect	2200	1590			IB011.9 ●●●/##
+ 1 spot 8 direct	2200	665	695	508	
17 indirect	2200	1590			
+ 2 spots 16 direct	2200	1330	1390	1016	IB012.9 ●●●/##
17 indirect	2200	1590			
+ 3 spots 24 direct	2200	1995	2085	1524	

Accessori - accessories: IB100: Modulo comandi + Command module

ACCESSORI / ACCESSORIES



MODULO COMANDI | COMMAND MODULE accensione/dimmerazione | switch on/off & dimmable

CODE
IB100 /##

VERSIONI DISPONIBILI/AVAILABLE VERSION

- **KELVIN**
 - 27 2700K
 - 30 3000K
 - 35 3500K
 - 40 4000K
- **FASCIO/BEAM**
 - S Spot
 - F Flood
 - Z Asymmetric
- **DIMMABLE (OPTIONAL)**
 - D Dali



Per i gradi vedere in tabella - For degree check the table

COMPOSIZIONE CODICE: xxx.x●●●/##
HOW TO CREATE THE CODE: **F1000.827SD/01**





IBRIDA PARETE | WALL

LUCE INDIRETTA |
INDIRECT LIGHT

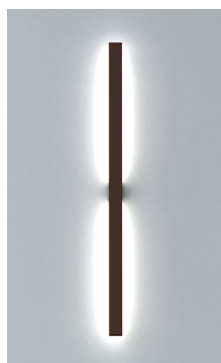

LUCE INDIRETTA | INDIRECT LIGHT

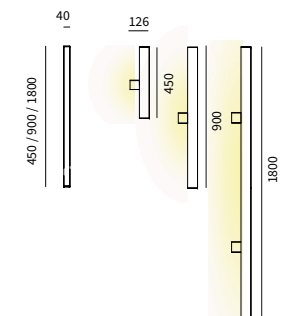

LED W	Lmm	Wmm	Hmm	lm product/beam 3000K	CODE
4,5	40	126	450	386	IB020.9 ●●●/##
9	40	126	900	835	IB021.9 ●●●/##
17	40	126	1800	1590	IB022.9 ●●●/##

LUCE SPOT DIRETTA |
DIRECT SPOT LIGHT

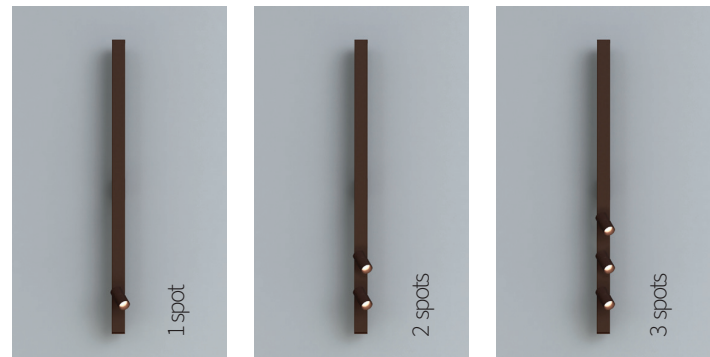

LUCE SPOT DIRETTA | DIRECT SPOT LIGHT

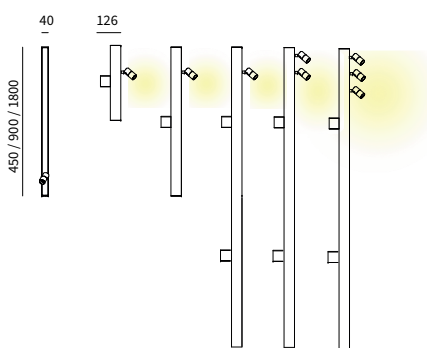

LED W	Lmm	Pmm	Hmm	lm product/beam 3000K	S19°	F28°	Z18°x38°	CODE
1 x 8	40	126	450	665	695	508	IB023.9 ●●●/##	
1 x 8	40	126	900	665	695	508	IB024.9 ●●●/##	
1 x 8	40	126	1800	665	695	508	IB025.9 ●●●/##	
2 x 8	40	126	1800	1330	1390	1016	IB026.9 ●●●/##	
3 x 8	40	126	1800	1995	2085	1524	IB027.9 ●●●/##	

Accessori - accessories: IB100: Modulo comandi + Command module

IBRIDA

Ibrida è una collezione di prodotti da parete o da terra che permette grande personalizzazione. Esiste proposta in moduli finiti, ma è tramite il sistema componibile che raggiunge la sua massima espressione. Caratterizzato da un profilo di alluminio che ospita una linea led che può essere installata sia diretta che indiretta, completo di diffusore in policarbonato opalino. Possibilità di aggiungere sino a 3 proiettori Focus per una luce diretta e puntuale. IP20

Hybrid is a wall or floor lamp collection that allows great customization. It exists in default modules, but it is through the modular system that reaches its maximum expression. Characterized by an aluminum profile that houses a led line both direct and indirect, complete with opal polycarbonate diffuser. Possibility to add spotlights Focus for a direct and punctual light. IP20



LUCE DIRETTA E INDIRETTA |
DIRECT AND INDIRECT LIGHT

LUCE DIRETTA E INDIRETTA |
DIRECT AND INDIRECT LIGHT

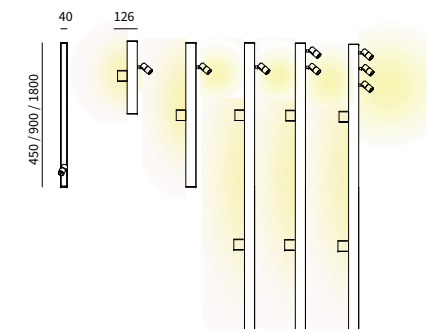

LED W	ø	H	lm product/beam 3000K	CODE
4,5 indirect			386	IB028.9 ●●●/##
+ 1 spot x 8 direct	36	450	S19° F28° Z18°x38° 665 695 508	
9 indirect			835	
1 spot x 8 direct	36	900	S19° F28° Z18°x38° 665 695 508	IB029.9 ●●●/##
17 indirect			1590	
+ 1 spot x 8 direct	36	1800	S19° F28° Z18°x38° 665 695 508	IB031.9 ●●●/##
17 indirect			1590	
+ 2 spots 16 direct	36	1800	S19° F28° Z18°x38° 1330 1390 1016	IB032.9 ●●●/##
17 indirect			1590	
+ 3 spots x 24 direct	36	1800	S19° F28° Z18°x38° 1995 2085 1524	IB033.9 ●●●/##

Accessori - accessories: IB100: Modulo comandi + Command module

ACCESSORI / ACCESSORIES



MODULO COMANDI | COMMAND MODULE **accensione/dimmerazione** | switch on/off & dimmable

CODE
IB100 /##



/## FINITURA | FINISHING

- /01 bianco | white
- /02 nero | black
- /49 bronzo | bronze

/## FINITURA PREMIUM | PREMIUM FINISHING

- /81 oro rosa | rose gold
- /82 bronzo anticato | antique bronze
- /83 ottone brunito spazzolato/brushed burnished brass

VERSIONI DISPONIBILI/AVAILABLE VERSION

- **KELVIN**
- 27 2700K
- 30 3000K
- 35 3500K
- 40 4000K

- **FASCIO/BEAM**
- S** Spot
- F** Flood
- Z** Asymmetric

- **DIMMABLE (OPTIONAL)**
- D** Dali

COMPOSIZIONE CODICE: xxx.X ●●●/##
HOW TO CREATE THE CODE: **F1000.827SD/01**

CODE
F1000.8 ●●●/## — finishing
base code kelvin beam dimmable

Per i gradi vedere in tabella - For degree check the table

IBRIDA

SISTEMA | SYSTEM



WALL - CEILING
SUSPENSION - FLOOR



IBRIDA SYSTEMA | SYSTEM

PROFILO VUOTO COMPLETO DI ATTACCO A MURO / EMPTY PROFILE COMPLETE WITH WALL MOUNTS



Lmm	Kg	CODE
450	0,95	IB000.450 /##
900	2,00	IB000.900 /##
1800	2,60	IB000.1800 /##

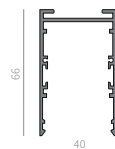

COPPIA DI TESTATE PER PROFILO / COUPLE OF CLOSURE HEADS



CODE
LT2403/##

REGELETTE

FILE SISTEMA REGLETTE LED 24W/M / 24W/M LED BATTEN



Alimentatore incluso | Driver included

LED 24W/m	Lmm	with opal diffuser	with microprismatic diffuser	CODE
12,8	560	721	964	R18FM0.8**
19,2	840	1082	1446	R18FM1.8
25,6	1120	1442	1928	R18FM2.8
32	1400	1803	2410	R18FM3.8
38,4	1680	2163	2892	R18FM4.8
44,8	1985	2524	3374	R18FM5.8
51,2	2240	2884	3856	R18FM6.8

* Note: Disponibile per le seguenti misure: 560, 1120, 1680, 2240mm. Gli apparecchi con temperatura di colore variabile (Tunable White) vengono forniti comprensivi di alimentatore DALI. Available for the following sizes: 560, 1120, 1680, 2240mm. The devices with variable color temperature (Tunable White) are supplied with integrated DALI power supply.
** Attenzione: non abbinare le reglette dimmerabili con codici R18FM0.8#D alle altre reglette di misura superiore perché potrebbero avere un comportamento differente durante la dimmerazione. | ** Attention: do not combine dimmable modules with codes R18FM0.8#D with other larger modules because they might have different dimming results.

FILE SISTEMA REGLETTE LED 32W/M / 32W/M LED BATTEN



Alimentatore incluso | Driver included

LED 32W/m	Lmm	with opal diffuser	with microprismatic diffuser	CODE
18	560	1119	1309	R18FH0.9
27	840	1679	1964	R18FH1.9
36	1120	2238	2618	R18FH2.9
45	1400	2798	3273	R18FH3.9
54	1680	3357	3927	R18FH4.9
63	1960	3917	4582	R18FH5.9
72	2240	4476	5236	R18FH6.9
81	2520	5036	5891	R18FH7.9
90	2800	5595	6545	R18FH8.9

○ 2700K non disponibile | 2700K not available

LINEA DI LUCE

LINEA DI LUCE DA 5 METRI/ LED LINE 5 METERS ROLL



Linea di luce Led IP20 24V									
W/m	V	Led/m	lm/m	lm/W	CRI	IP	Lmm	CODE	
4,8	24	120	620	129	90	20	5000	ST05.0.5	
9,6	24	160	1220	127	90	20	5000	ST10.0.5	
22	24	240	2700	123	90	20	5000	ST22.0.5	
16,8	24	COB	1400	2700-6500K	84	90	20	5000	ST22.TW.5

Linea di luce Led IP67 24V									
W/m	V	Led/m	lm/m	lm/W	CRI	IP	Lmm	CODE	
9,6	24	160	1073	111	90	67	5000	ST10.0.5IP	
16,8	24	200	1822	108	90	67	5000	ST18.0.5IP	

CUTS

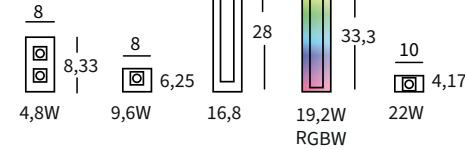

Linea di luce RGB-RGBW 24V

W/m	V	Led/m	lm/m	type	cut	IP	Lmm	CODE
19,2	24	COB	640	RGBW 2700K	33,3	20	5000	ST19.2.RGBW.5
19,2	24	COB	655	RGBW 3000K	33,3	20	5000	ST20.RGBW.5
19,2	24	COB	540	RGBW 2700K	33,3	67	5000	ST19.RGBW.5IP
25+22,5	24	270	4100	RGB + White 3500K	55,4	20	5000	ST19.RGBW.5

DISSIPATORE DIRETTO PER STRIP LED/ DIRECT EMISSION HEATSINK FOR STRIP LED MOLLA SINGOLA PER DISSIPATORE/ SINGLE SPRING

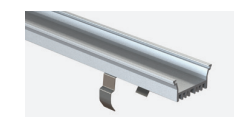

molle incluse/ included springs	Lmm	CODE
n.2	1000	LTC1.1000/27
n.3	2000	LTC1.2000/27
n.3	3000	LTC1.3000/27
----	----	LTC1.misura/27



CODE
LTC1.ML

1 ogni metro / 1 every meter

In caso di tagli ordinare altre molle / Should you need to cut on-site, please order more springs

/## FINITURA | FINISHING

- /01 bianco | white
- /02 nero | black
- /49 bronzo | bronze

/## FINITURA PREMIUM | PREMIUM FINISHING

- /81 oro rosa | rose gold
- /82 bronzo antico | antique bronze
- /83 ottone brunito spazzolato/brushed burnished brass

DRIVERS VEDI | SEE P. 452

MODULI PROIETTORI / PROJECTORS MODULES



LED W	mA	lm product/beam 3000K			CODE
		S19°	F28°	Z18°x38°	
1x 8	700	665	695	508	IB041.9 ●●● /##
2 X 8	700	1330	1390	1016	IB042.9 ●●● /##
3 X 8	700	1995	2085	1524	IB043.9 ●●● /##

MODULO COMANDI | COMMAND MODULE accensione/dimmerazione | switch on/off & dimmable



CODE
IB100 /##

DIFFUSORE IN POLICARBONATO OPALINO PER LUCE DIRETTA / OPAL DIRECT WHITE POLYCARBONATE DIFFUSER

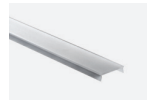

Lmm	Kg	CODE
1000	0,16	LT239P.1000
2000	0,33	LT239P.2000
3000	0,50	LT239P.3000
-----		LT239P.misura

PIASTRA DI CHIUSURA IN ESTRUSO DI ALLUMINIO / EXTRUDED ALUMINIUM CLOSING COVER



Molle incluse/springs included	Lmm	CODE
n. 2	1000	F16.1000/##
n. 3	2000	F16.2000/##
n. 4	3000	F16.3000/##
-----		F16.misura/##

MOLLA PER PIASTRA DI CHIUSURA / SPRING FOR CLOSING COVER



CODE
F1.MLC

Una ogni 70 cm da ordinare solo in caso di tagli della piastra di chiusura | One every 70 cm. To be ordered in case of cut of the closing cover.

DIFFUSORE IN POLICARBONATO OPALINO INDIRETTO / OPAL INDIRECT WHITE POLYCARBONATE DIFFUSER



Lmm	Kg	CODE
1000	0,16	LT240P.1000
2000	0,33	LT240P.2000
3000	0,50	LT240P.3000
-----		LT240P.misura



/## FINITURA | FINISHING

- /01 bianco | white
- /02 nero | black
- /49 bronzo | bronze

/## FINITURA PREMIUM | PREMIUM FINISHING

- /81 oro rosa | rose gold
- /82 bronzo antico | antique bronze
- /83 ottone brunito spazzolato/brushed burnished brass

/## FINITURA PIASTRA DI CHIUSURA | COVER FINISHING

- /01 bianco | white
- /02 nero | black
- /12 grigio | grey
- /49 bronzo | bronze



IBRIDA SISTEMA | SYSTEM

WALL - CEILING
SUSPENSION - FLOOR

VERSIONI DISPONIBILI/AVAILABLE VERSION

- KELVIN
 - 27 2700K
 - 30 3000K
 - 35 3500K
 - 40 4000K
- FASCIO/BEAM
 - S Spot
 - F Flood
 - Z Asymmetric

Per i gradi vedere in tabella - For degree check the table

COMPOSIZIONE CODICE: xxx.x ●● /##

HOW TO CREATE THE CODE: F1000.827S /01

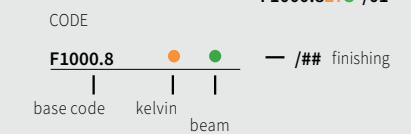

700 DRIVERS VEDI | SEE P. 452

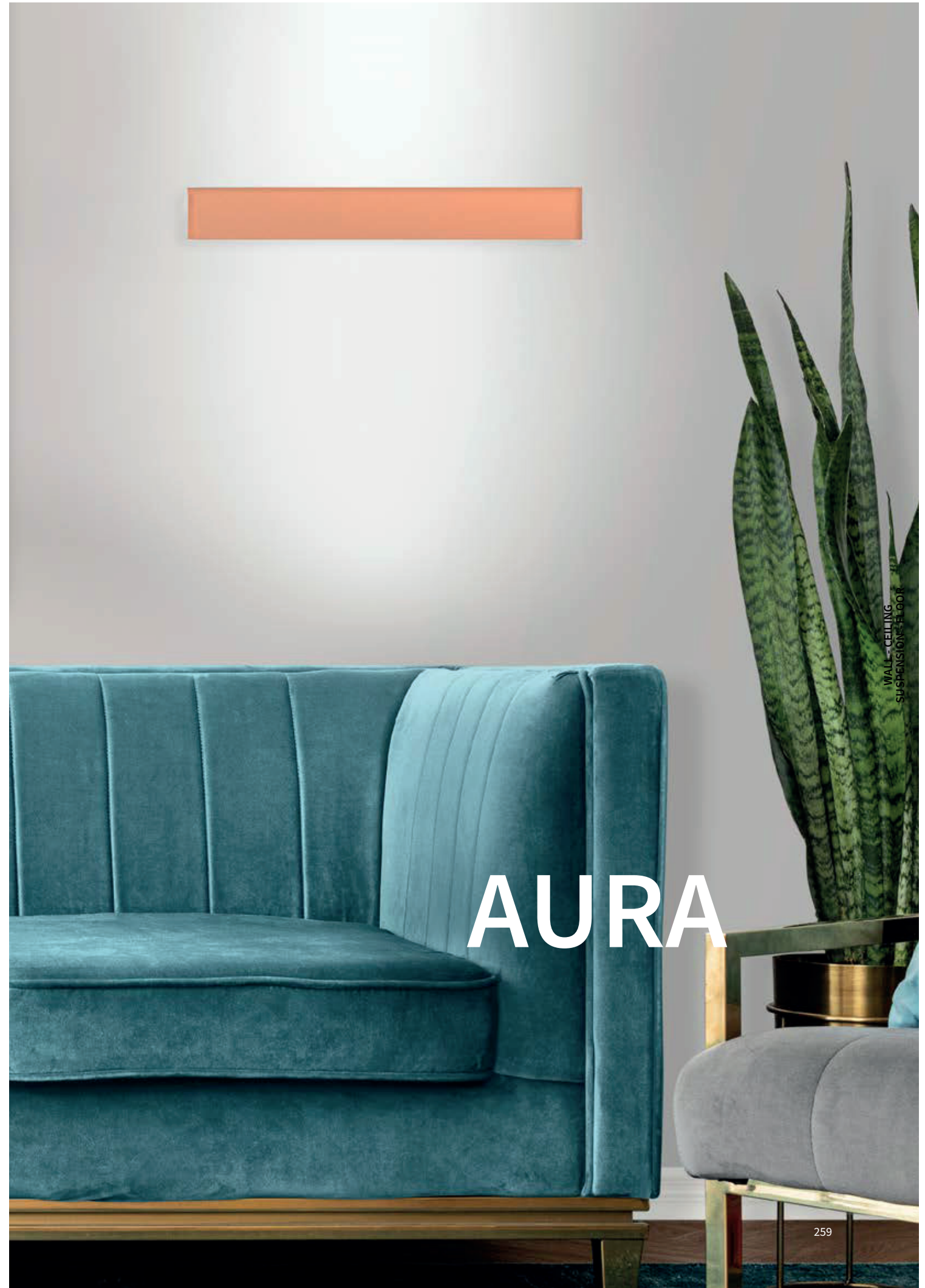
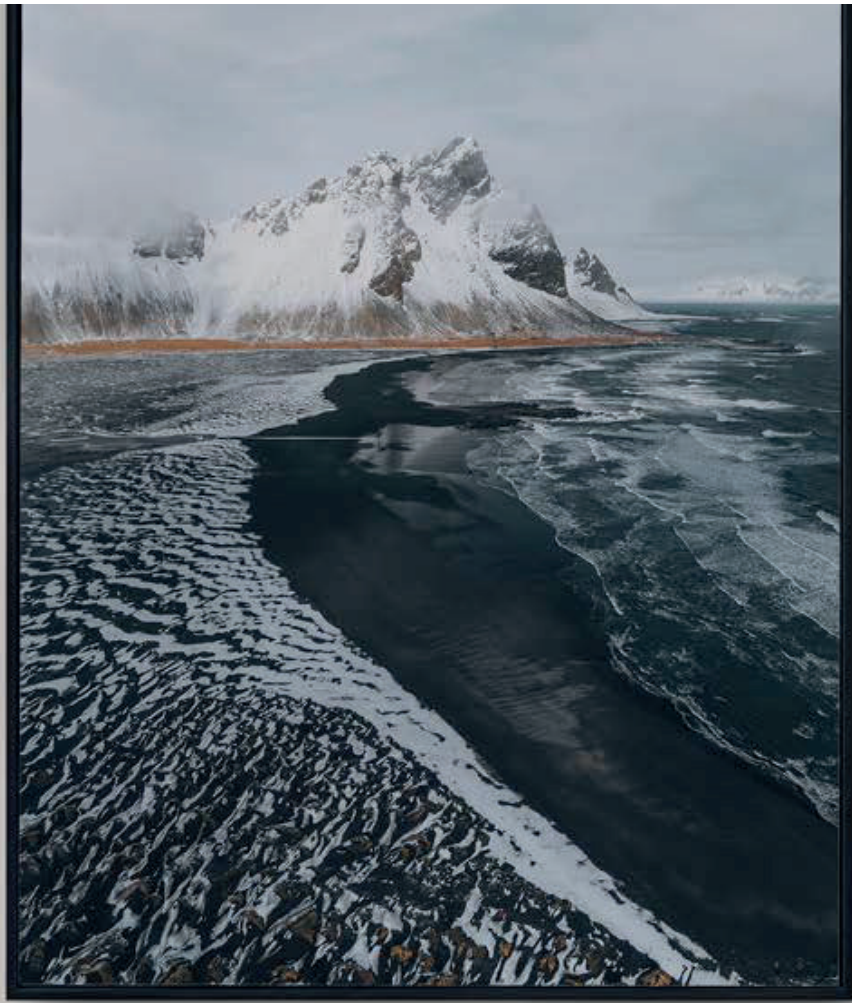

WALL - CEILING
SUSPENSION - FLOOR

AURA

AURA IN



VERSIONE BASE | BASIC VERSION

VERSIONE CON COVER | VERSION WITH COVER

Raffinata eleganza che coniuga funzionalità e discrezione Aura la nuova lampada da parete biemissione, dalle linee minimaliste, completa di luce lineare led. Apparecchio disponibile in due misure, 350 mm e 520 mm, in versione di colore bianco, nero e corten. Possibilità di essere personalizzato con la cover accessoria, disponibile nei colori bianco, nero, oro champagne, corten o grafite. Classe di protezione IP40. Disponibile anche in versione da esterno (Aura out).

Refined elegance that combines functionality and discretion Aura the new wall lamp biemissione, minimalist lines, complete with linear LED light. Luminaire available in two sizes, 350 mm and 520 mm, in white, black and corten. Possibility to be customized with the accessory cover, available in white, black, champagne gold, corten or graphite. Protection class IP40. Also available in outdoor version (Aura out).

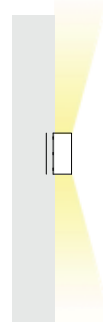

UK CONFORMITY ASSESSMENT E EUROPEAN CERTIFICATION / UK CONFORMITY ASSESMENT AND EUROPEAN CERTIFICATION



PRODOTTI COSTRUITI CON MATERIALE RICICLABILE / PRODUCTS MADE OF RECYCLABLE MATERIAL



GARANZIA DI 5 ANNI / 5-YEAR WARRANTY

KELVIN		
27		2700°K
30		3000°K
35		3500°K
40		4000°K

FINITURE STANDARD / STANDARD FINISHINGS		
/01		BIANCO/WHITE
/02		NERO/BLACK
/44C		ORO CHAMPAGNE/ GOLD
/60		CORTEN/CORTEN
/99		GRAFITE/GRAPHITE

FINITURE PREMIUM / PREMIUM FINISHINGS		
/81		ORO ROSA/ROSE GOLD
/82		BRONZO ANTICATO/ ANTIQUE BRONZE
/83		OTTONE BRUNITO SPAZZOLATO/ BRUSHED BURNISHED BRASS

AURA IN BIEMISSIONE

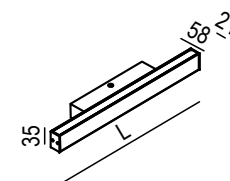

LED 24V	Lmm	lm product/beam 3000K	CODE
W 11	350	1203	AU00.9 ●● /##
LED	Lmm	lm product/beam 3000K	CODE
W 16	520	1800	AU01.9 ●● /##

ACCESSORI OPZIONALI / OPTIONAL ACCESSORIES

PANNELLO DI COPERTURA | COVER

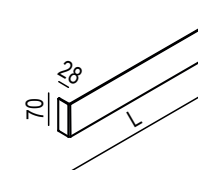
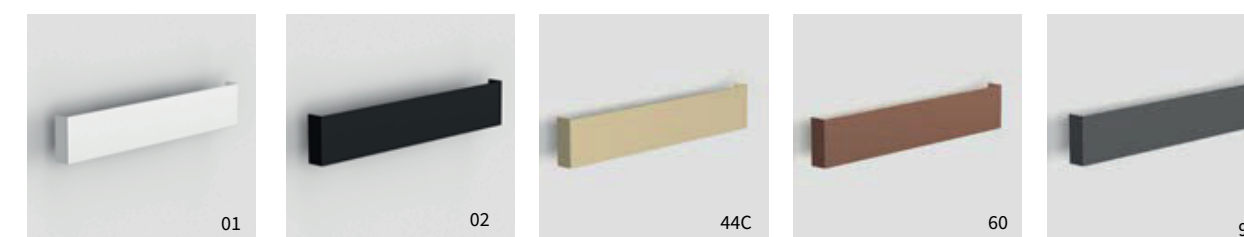

Lmm	CODE
393	AU00.C /##
Lmm	CODE
540	AU01.C /##

WALL - CEILING
SUSPENSION - FLOOR

KELVIN	DIMMABLE (OPTIONAL)
27 2700K	D Dali
30 3000K	
35 3500K	
40 4000K	

COMPOSIZIONE CODICE: xxx.X ●● /##
HOW TO CREATE THE CODE: F1000.8 27 D /01

CODE
F1000.8 ●● /## — finishing

base code kelvin dimmable

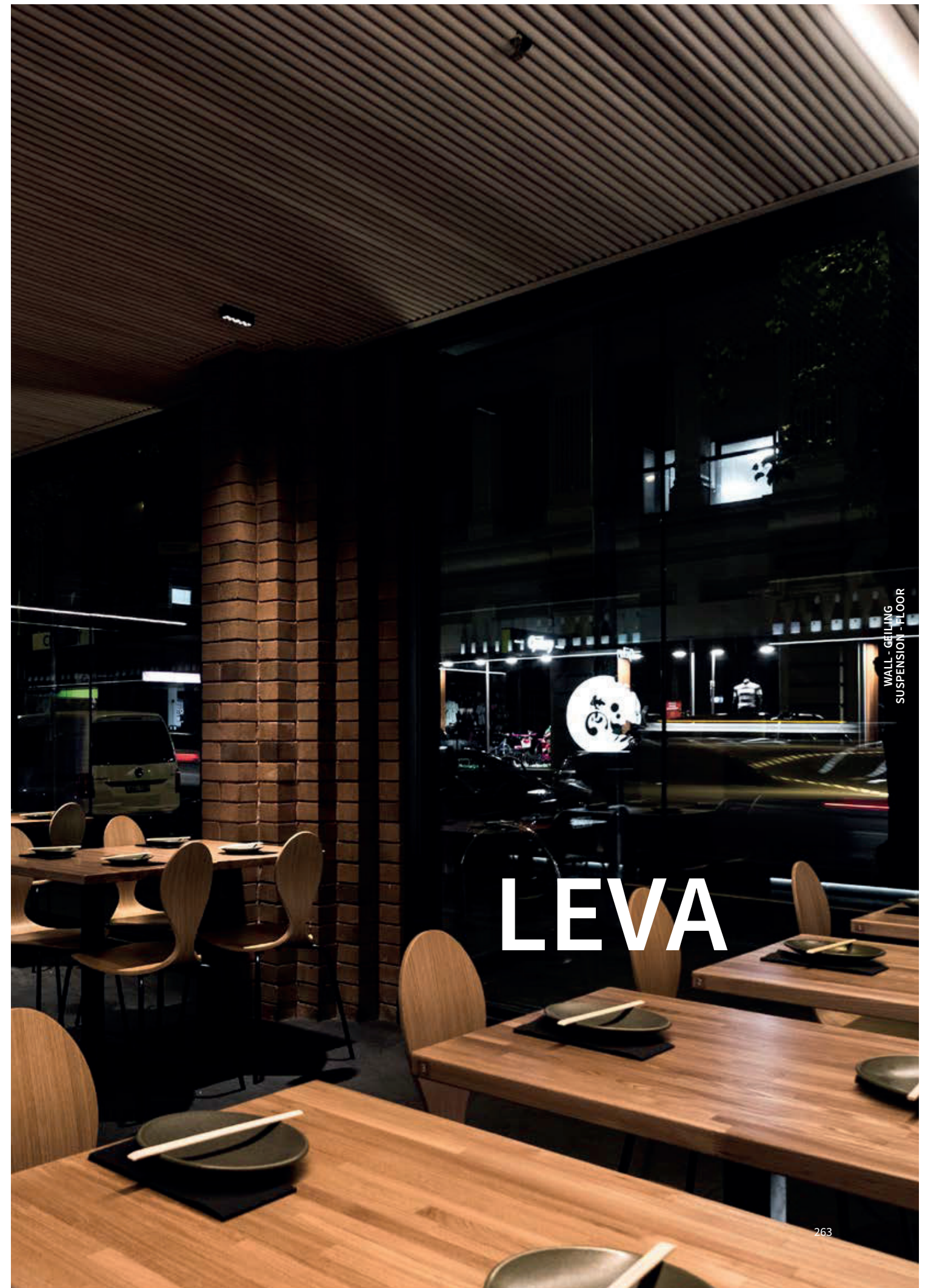

LEVA

LEVA

LINEARI | LINEAR VERSION

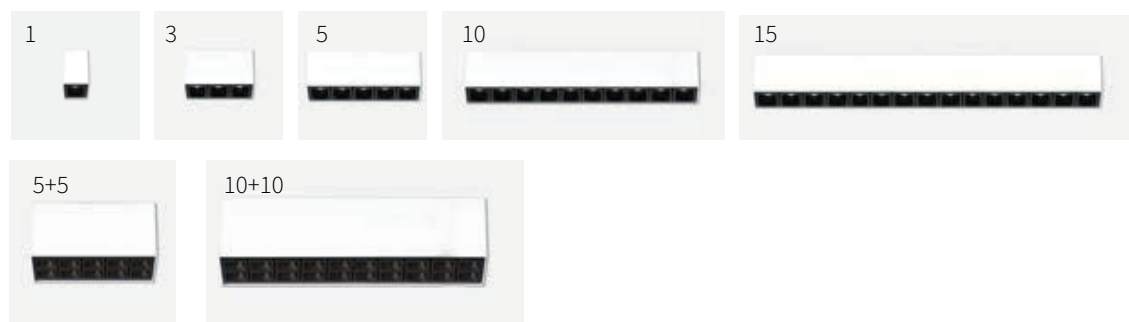

Collezione di apparecchi da incasso, fissi ed orientabili, con sorgenti LED Chip On Board integrate installabili a soffitto o parete. Corpo apparecchio in estruso di alluminio verniciato. Gruppi ottici antiabbagliamento completi di led chip on board (CRI>90) e lenti. Installabili anche nel container Minifile e File2 mediante apposite staffe. Ottiche spot, flood, wideflood ed ellittiche UGR<16. Alimentatori elettronici remoti on/off inclusi tranne che per i modelli ad una e tre luci. Grado di protezione IP20/IP43.

Collection of recessed luminaires, fixed and adjustable, with integrated Chip On Board LED sources. Ceiling or wall mounted. Luminaire body in painted extruded aluminum. Anti-glare optical groups complete with LED chip on board (CRI> 90) and lenses. They can also be installed in the Minifile and File2 containers using the special brackets as accessory. Spot, flood, wideflood and elliptical optics UGR <16. On/off remote electronic drivers included except for one and three light models. IP20/IP43.



UK CONFORMITY ASSESSMENT E EUROPEAN CERTIFICATION / UK CONFORMITY ASSESSTMENT AND EUROPEAN CERTIFICATION



PRODOTTI COSTRUITI CON MATERIALE RICICLABILE / PRODUCTS MADE OF RECYCLABLE MATERIAL



GARANZIA DI 5 ANNI / 5-YEAR WARRANTY

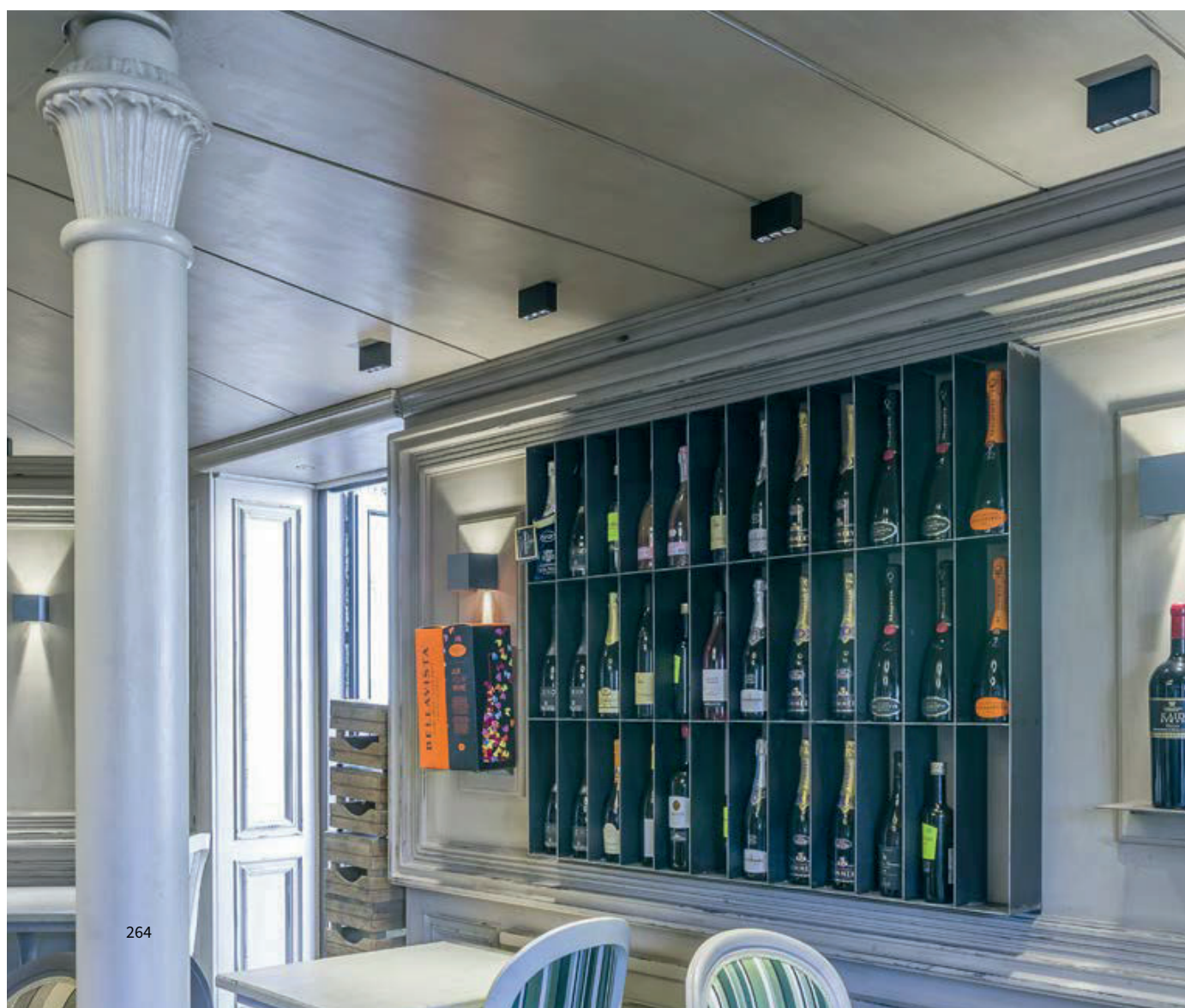

KELVIN

27		2700°K
30		3000°K
35		3500°K
40		4000°K

FASCIO/BEAM

	SPOT 20°
	FLOOD 32°
	WIDE 50°
	ASYMMETRIC 41°X18°

FINITURE STANDARD /STANDARD FINISHINGS

/01		TELAIO BIANCO OTTICA NERA/ WHITE FRAME BLACK OPTIC
/02		TELAIO NERO OTTICA NERA/ BLACK FRAME BLACK OPTIC
/41		TELAIO BIANCO OTTICA BIANCA/ WHITE FRAME WHITE OPTIC
/42		TELAIO NERO OTTICA ORO/ BLACK FRAME GOLD OPTIC

TW



Tunable White 2700 – 5000°K

La tecnologia Tunable White consente di controllare la temperatura di colore delle sorgenti luminose permettendo di scegliere quella più adatta tra luce bianca calda e fredda. / Tunable White technology allows you to control the color temperature of light sources allowing you to choose the most suitable between warm and cold white light.

FINITURE PREMIUM /PREMIUM FINISHINGS

	81-ORO ROSA/ PINK GOLD		82-BRONZO ANTICATO/ ANTIQUE BRONZE		83-OTTONE BRUNITO SPAZZOLATO/BRUSHED BURNISHED BRASS
--	---------------------------	--	---	--	--

CURVE FOTOMETRICHE/PHOTOMETRIC DATA

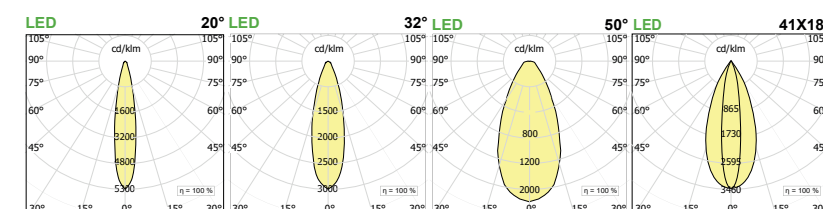



VERSIONI ALIMENTATORI ESCLUSI-POWER SUPPLIER NOT INCLUDED

LEVA SOFFITTO/PARETE 1 WALL/CEILING



LED		Dim.				H	Kg	lm prod./beam 3000K				CODE	
W	mA	20°	32°	50°	41°x18°			20°	32°	50°	41°x18°		
2,2	700	32x40	62	0.16	200	186	166	175	LV021.9				●●●/##

Da completare con alimentatore da installare remoto in scatola di derivazione. Per installazione in Container Minifile ordinare n.1 LTM210 staffa per fissaggio modulo luminoso all'interno della cassaforma. | To be completed with power supply to be installed in a remote junction box. To install in Container Minifile order n.1 LTM210 single bracket to fix the lighting module within the wallbox.

LEVA SOFFITTO/PARETE 3 WALL/CEILING



LED		Dim.				H	Kg	lm prod./beam 3000K				CODE	
W	mA	20°	32°	50°	41°x18°			20°	32°	50°	41°x18°		
6,6	700	32x100	62	0.26	601	558	496	526	LV026.9				●●●/##

Da completare con alimentatore da installare remoto in scatola di derivazione. Per installazione in Container Minifile ordinare n.2 LTM210 staffa per fissaggio modulo luminoso all'interno della cassaforma. | To be completed with power supply to be installed in a remote junction box. To install in Container Minifile order n.2 LTM210 single bracket to fix the lighting module within the wallbox.

VERSIONI ALIMENTATORI INCLUSI-INTEGRATED POWER SUPPLIES (ON/OFF)

LEVA SOFFITTO/PARETE 5 WALL/CEILING

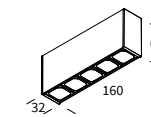

LED		Dim.				H	Kg	lm prod./beam 3000K				CODE	
W	mA	20°	32°	50°	41°x18°			20°	32°	50°	41°x18°		
11		32x160	62	0.34	1002	931	828	877	LV027.9				●●●/##

Per installazione in Container Minifile ordinare n.2 LTM210 staffa per fissaggio modulo luminoso all'interno della cassaforma. To install in Container Minifile order n.2 LTM210 single bracket to fix the lighting module within the wallbox.

LEVA SOFFITTO/PARETE 10 WALL/CEILING

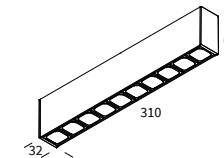

LED		Dim.				H	Kg	lm product/beam 3000K				CODE	
W	mA	20°	32°	50°	41°x18°			20°	32°	50°	41°x18°		
22		32x310	62	0.66	2004	1862	1656	1754	LV028.9				●●●/##

Per installazione in Container Minifile ordinare n.2 LTM210 staffa per fissaggio modulo luminoso all'interno della cassaforma. To install in Container Minifile order n.2 LTM210 single bracket to fix the lighting module within the wallbox.

LEVA SOFFITTO/PARETE 15 WALL/CEILING

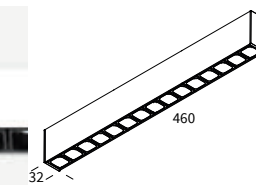

LED		Dim.				H	Kg	lm product/beam 3000K				CODE	
W	mA	20°	32°	50°	41°x18°			20°	32°	50°	41°x18°		
33		32x460	62	0.91	3006	2793	2484	2631	LV029.9				●●●/##

Per installazione in Container Minifile ordinare n.2 LTM210 staffa per fissaggio modulo luminoso all'interno della cassaforma. | To install in Container Minifile order n.2 LTM210 single bracket to fix the lighting module within the wallbox.

LEVA SOFFITTO/PARETE 5+5 WALL/CEILING

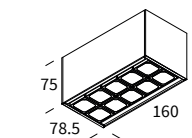

LED		Dim.				H	Kg	lm prod./beam 3000K				CODE
W	mA	20°	32°	50°				20°	32°	50°		
22		78.5x160	75	0.88	2000	1862	1656	LV083.9				●●●/##

Per installazione in Container File 2 ordinare n.2 LT2891 staffa per fissaggio modulo luminoso all'interno della cassaforma. To install in Container File 2 order n.2 LT2891 single bracket to fix the lighting module within the wallbox.

LEVA SOFFITTO/PARETE 10+10 WALL/CEILING

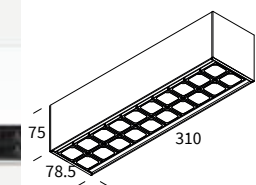

LED		Dim.				H	Kg	lm prod./beam 3000K				CODE
W	mA	20°	32°	50°				20°	32°	50°		
44		78.5x310	75	1,2	4000	3724	3312	LV084.9				●●●/##

Per installazione in Container File 2 ordinare n.2 LT2891 staffa per fissaggio modulo luminoso all'interno della cassaforma. To install in Container File 2 order n.2 LT2891 single bracket to fix the lighting module within the wallbox.

VERSIONI DISPONIBILI/AVAILABLE VERSION

- **KELVIN**
- **FASCIO/BEAM**
- **FASCIO/BEAM**
- **DIMMABLE (OPTIONAL)**
- 27 2700K
- S Spot
- S Spot
- D Dali
- 30 3000K
- F Flood
- F Flood
- TW Tunable white
- W Wide
- W Wide
- Z Asymmetric
- Z Asymmetric

Per i gradi vedere in tabella - For degree check the table

/## FINITURA/FINISHING

- ☐ /01 telaio bianco, ottica nera | white frame, black optic
- ☐ /02 telaio nero, ottica nera | black frame, black optic
- ☐ /41 telaio bianco, ottica bianca | white frame, white optic
- ☐ /42 telaio nero, ottica oro | black frame, gold optic

700 DRIVERS VEDI | SEEP. 452



WALL - CEILING
SUSPENSION - FLOOR

FILE 2

COMPLEMENTI

FILE 2 COMPLEMENTI

Apparecchi a soffitto per illuminazione diretta, completi di sorgenti LED professionali o per lampade GU10 LED. Corpo quadrato o rettangolare in lamiera di acciaio verniciata. Completi di staffa per fissaggio a soffitto. Sugeriti in abbinamento a moduli finiti e profili File2 oppure all'interno del Containers File2.

Ceiling fixtures for direct lighting, complete with professional LED sources or for GU10 LED lamps. Square or rectangular body in painted steel. Complete with bracket for ceiling fixing. Recommended in combination with finished modules and File2 profiles or inside the File2 Containers.



UK CONFORMITY ASSESSMENT E EUROPEAN CERTIFICATION / UK CONFORMITY ASSESSTMENT AND EUROPEAN CERTIFICATION



PRODOTTI COSTRUITI CON MATERIALE RICICLABILE / PRODUCTS MADE OF RECYCLABLE MATERIAL



GARANZIA DI 5 ANNI / 5-YEAR WARRANTY



GU10

VERSIONI CON SORGENTE LED GU10 DISPONIBILI / GU10 LIGHT SOURCE VERSION AVAILABLE

KELVIN		
27		2700°K
30		3000°K
35		3500°K
40		4000°K

FASCIO/BEAM		
F		FLOOD
W		WIDE

FINITURE STANDARD / STANDARD FINISHINGS

/01		BIANCO/WHITE
/02		NERO/BLACK
/49		BRONZO/BRONZE

FINITURE PREMIUM / PREMIUM FINISHINGS

/81		ORO ROSA/ROSE GOLD
/82		BRONZO ANTICATO/ANTIQUE BRONZE
/83		OTTONE BRUNITO SPAZZOLATO/BRUSHED BURNISHED BRASS

FILE2 COMPLEMENTI 1

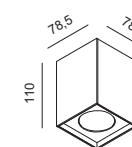

FILE2 COMPLEMENTI 2

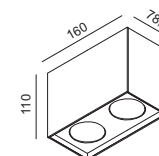

LED W	Dim.	H	lm product/beam 3000K F27°	W46°	CODE
8	78x78	110	860	860	LT2680.9 ●●/##
12	78x78	110	1285	1285	LT2681.9 ●●/##
GU10 LED 230V					
W	Dim.	H			CODE
50	78x78	110			LT2660 /##

LED W	Dim.	H	lm product/beam 3000K F24°	W36°	CODE
16	78x160	110	660	900	LT2661.9 ●●/##
GU10 LED 230V					
W	Dim.	H			CODE
100	78x160	110			LT2661 /##

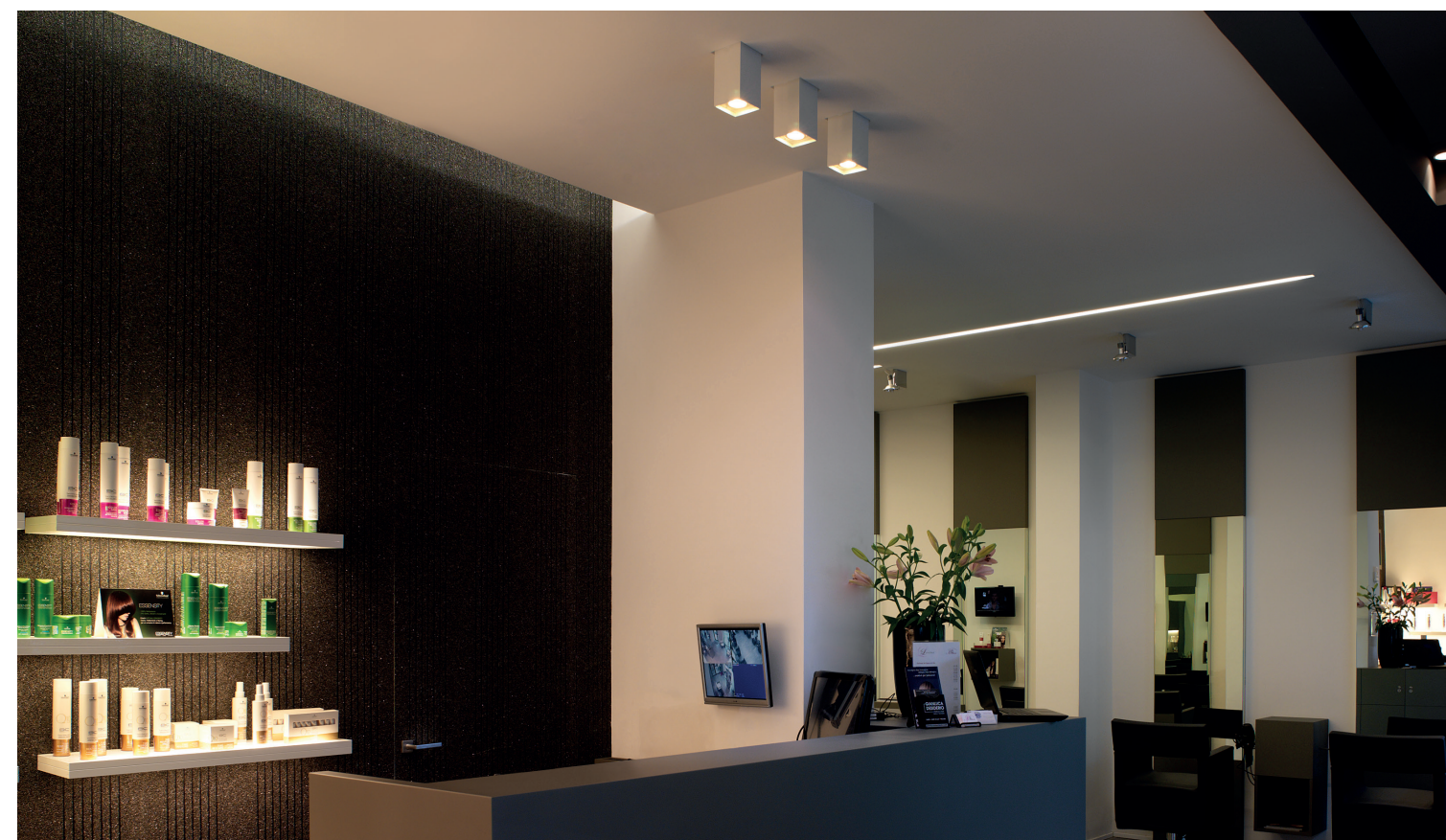

VERSIONI DISPONIBILI/AVAILABLE VERSION

● KELVIN	● FASCIO/BEAM
27 2700K	F Flood 24°
30 3000K	W Wide 36°
35 3500K	
40 4000K	

/## FINITURA/FINISHING

	/01 bianco white
	/02 nero black
	/49 bronzo/bronze

COMPOSIZIONE CODICE: xxx.x ●●/##
HOW TO CREATE THE CODE: F1000.827S/01

CODE				
F1000.8	●	●	/##	— finishing
base code	kelvin	beam		

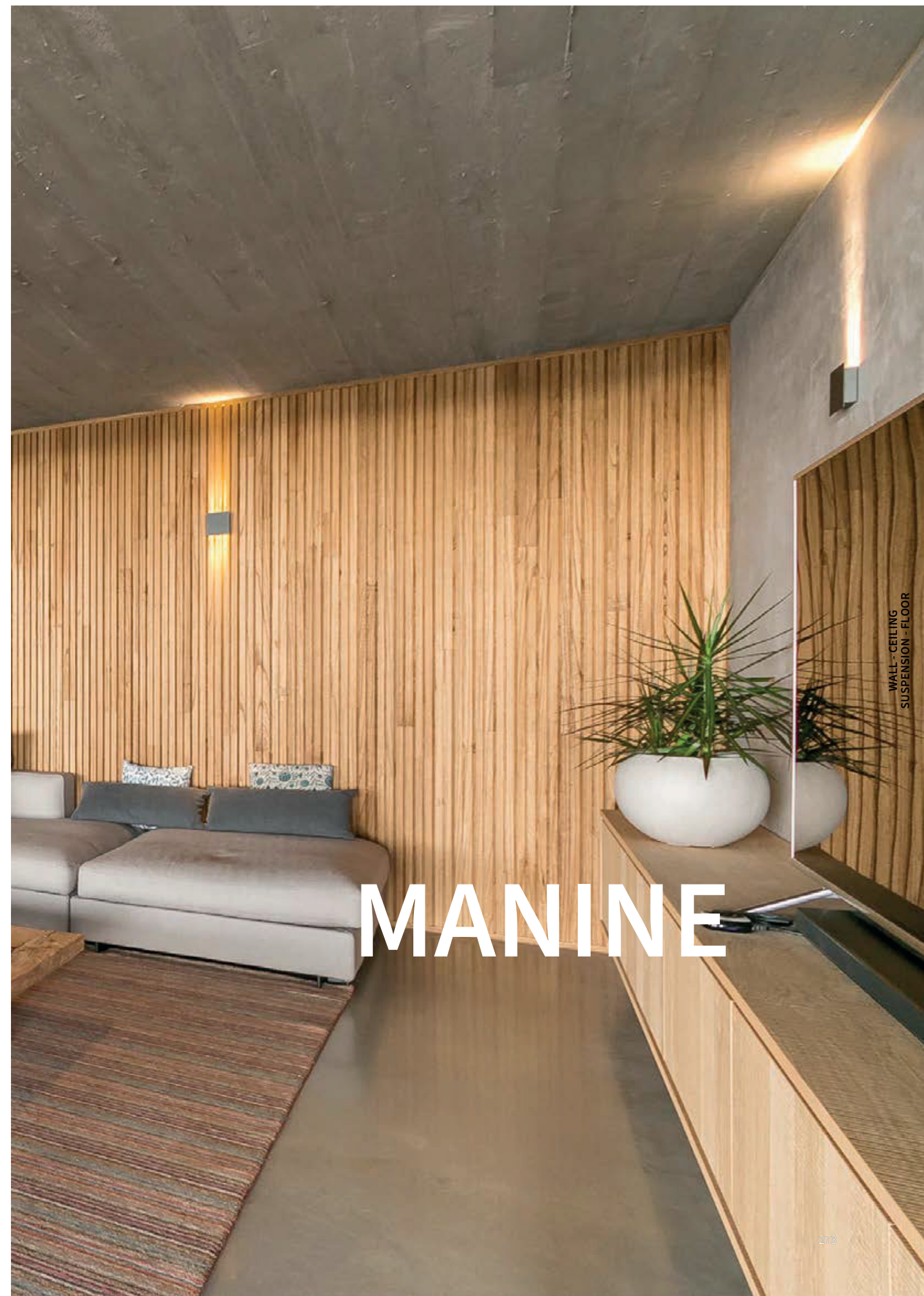

WALL - CEILING
SUSPENSION - FLOOR

MANINE

MANINE



Apparecchi a parete mono o biemissione per illuminazione d'accento e di pareti ed angoli. Gruppo ottico completo di sorgenti LED professionali, con alimentazione integrata. Disponibili in versione ad angolo interno 90°, ad angolo esterno 270° oppure piatta. Corpo in metallo finitura verniciata. Grado di protezione IP40.

Single or double emission wall mounted luminaires for wall enhancing and corner lighting. Optical unit complete with professional LED sources, with integrated power supply. Available in 90° internal angle, 270° external angle or flat version. Painted finish metal body. IP40.

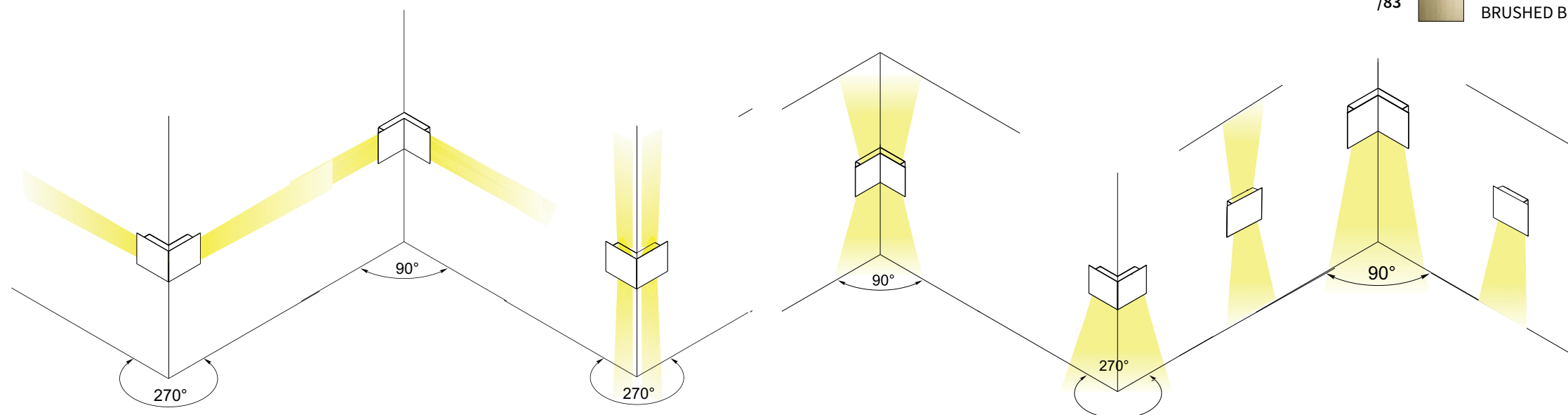

UK CONFORMITY ASSESSMENT E EUROPEAN CERTIFICATION / UK CONFORMITY ASSESSTMENT AND EUROPEAN CERTIFICATION



PRODOTTI COSTRUITI CON MATERIALE RICICLABILE / PRODUCTS MADE OF RECYCLABLE MATERIAL



GARANZIA DI 5 ANNI / 5-YEAR WARRANTY



FASCIO STRETTO / NARROW BEAM



FASCIO LARGO / WIDE BEAM

KELVIN

27		2700°K
30		3000°K
35		3500°K
40		4000°K

FASCIO/BEAM

	SPOT
	DIFFUSED

FINITURE STANDARD /STANDARD FINISHINGS

/01		BIANCO/WHITE
/02		NERO/BLACK
/60		CORTEN/CORTEN

FINITURE PREMIUM /PREMIUM FINISHINGS

/81		ORO ROSA/ROSE GOLD
/82		BRONZO ANTICATO/ ANTIQUE BRONZE
/83		OTTONE BRUNITO SPAZZOLATO/ BRUSHED BURNISHED BRASS

SPOT

MANINE 90 ANGOLO INTERNO | INTERNAL ANGLE

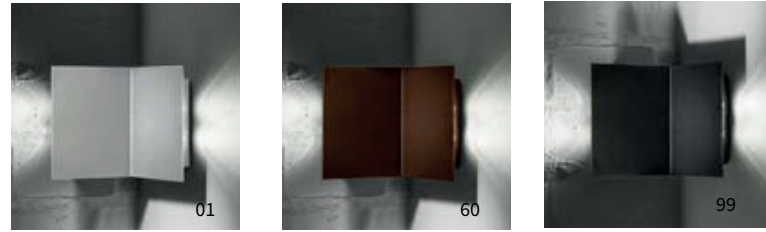
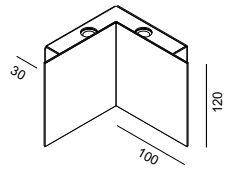

BIEMISSIONE ORIZZONTALE - HORIZONTAL DOUBLE EMISSION

LED	W	Kg	lm product/beam/3000K	CODE
2x3	0,82	368	S14°	LT7100.8 ● S/##

BIEMISSIONE VERTICALE - VERTICAL DOUBLE EMISSION

LED	W	Kg	lm product/beam/3000K	CODE
2x3	0,82	368	S14°	LT7104.8 ● S/##

MONOEMISSIONE VERTICALE - VERTICAL SINGLE EMISSION

LED	W	Kg	lm product/beam/3000K	CODE
3	0,78	184	S14°	LT7102.8 ● S/##

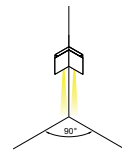
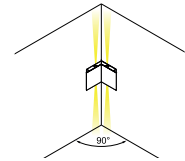
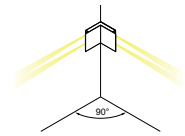

MANINE 270 ANGOLO ESTERNO | EXTERNAL ANGLE

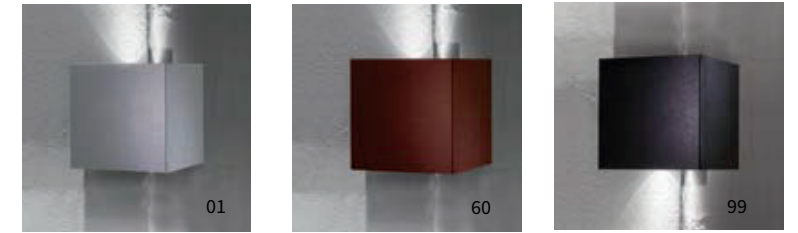
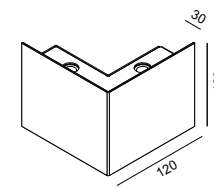

BIEMISSIONE ORIZZONTALE - HORIZONTAL DOUBLE EMISSION

LED	W	Kg	lm product/beam/3000K	CODE
2x3	0,82	368	S14°	LT7000.8 ● S/##

BIEMISSIONE VERTICALE - VERTICAL DOUBLE EMISSION

LED	W	Kg	lm product/beam/3000K	CODE
2x3	0,82	368	S14°	LT7004.8 ● S/##

MONOEMISSIONE VERTICALE - VERTICAL SINGLE EMISSION

LED	W	Kg	lm product/beam/3000K	CODE
3	0,78	184	S14°	LT7002.8 ● S/##

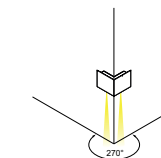
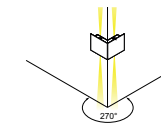
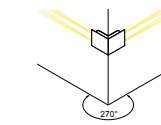

MANINE PARETE | WALL

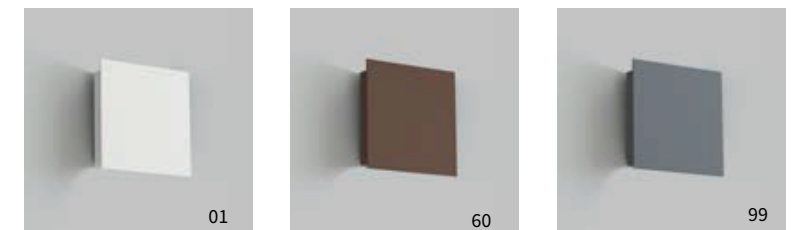
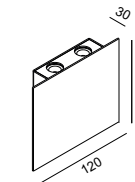

SINGLE EMISSION

LED	W	Kg	lm product/beam/3000K	CODE
3	0,52	184	S14°	LT7200.8 ● S/##

Posizionabile anche in orizzontale. | possible to be installed horizontally

DOUBLE EMISSION

LED	W	Kg	lm product/beam/3000K	CODE
2x3	0,56	368	S14°	LT7300.8 ● S/##

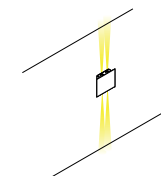
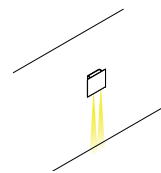

CURVE FOTOMETRICHE/ PHOTOMETRIC DATA

SPOT VERSION

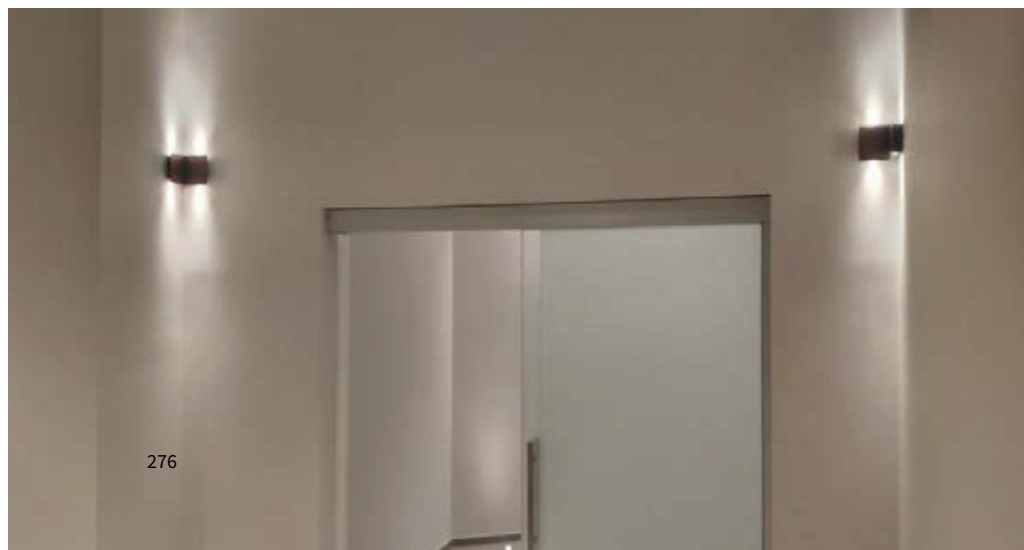
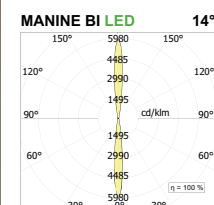
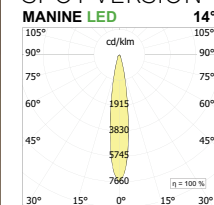

VERSIONI DISPONIBILI/AVAILABLE VERSION

- **KELVIN**
 - 27 2700K
 - 30 3000K
 - 35 3500K
 - 40 4000K
- **FASCIO/BEAM**
 - S Spot 14°

/## FINITURA/FINISHING

- 01 bianco / white
- 60 corten / corten
- 99 grafite / graphite

COMPOSIZIONE CODICE: xxx.x●●/##

HOW TO CREATE THE CODE: F1000.827S/01
 CODE
F1000.8 ● ● /## — finishing
 | | |
 base code kelvin beam

DIFFUSED

MANINE 90 ANGOLO INTERNO | INTERNAL ANGLE

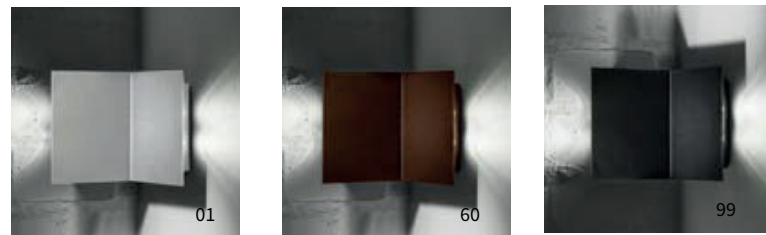
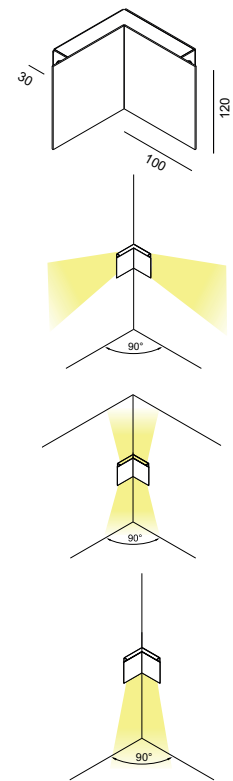

BIEMISSIONE ORIZZONTALE HORIZONTAL DOUBLE EMISSION

LED W	Kg	lm product/beam/3000K	CODE
2x13	0,82	30x100° 1380	MN003.9 ● /##

BIEMISSIONE VERTICALE VERTICAL DOUBLE EMISSION

LED W	Kg	lm product/beam/3000K	CODE
2x13	0,82	30x100° 1380	MN004.9 ● /##

MONOEMISSIONE VERTICALE VERTICAL SINGLE EMISSION

LED W	Kg	lm product/beam/3000K	CODE
13	0,78	30x100° 690	MN005.9 ● /##

MANINE PARETE | WALL

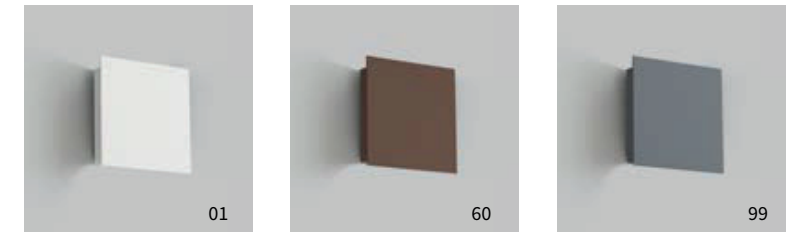
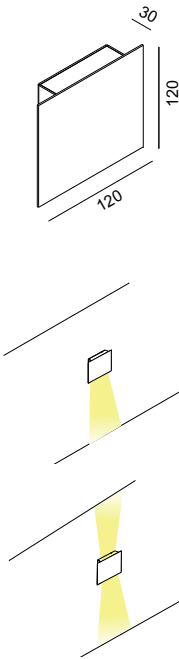

SINGLE EMISSION

LED W	Kg	lm product/beam/3000K	CODE
13	0,52	30x100° 690	MN006.9 ● /##

Posizionabile anche in orizzontale. | possible to be installed horizontally

DOUBLE EMISSION

LED W	Kg	lm product/beam/3000K	CODE
2x13	0,56	30x100° 1380	MN007.9 ● /##

MANINE 270 ANGOLO ESTERNO | EXTERNAL ANGLE

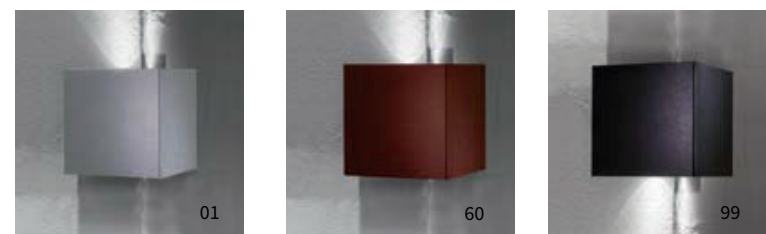
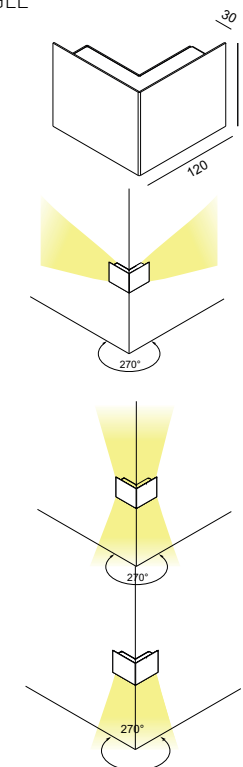

BIEMISSIONE ORIZZONTALE HORIZONTAL DOUBLE EMISSION

LED W	Kg	lm product/beam/3000K	CODE
2x13	0,82	30x100° 1380	MN000.9 ● /##

BIEMISSIONE VERTICALE VERTICAL DOUBLE EMISSION

LED W	Kg	lm product/beam/3000K	CODE
2x13	0,82	30x100° 1380	MN001.9 ● /##

MONOEMISSIONE VERTICALE VERTICAL SINGLE EMISSION

LED W	Kg	lm product/beam/3000K	CODE
13	0,78	30x100° 690	MN002.9 ● /##



CURVE FOTOMETRICHE/ PHOTOMETRIC DATA DIFFUSED VERSION

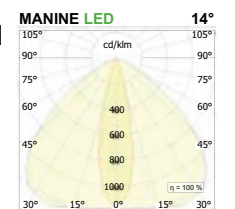

VERSIONI DISPONIBILI/AVAILABLE VERSION

- KELVIN
- 27 2700K
- 30 3000K
- 35 3500K
- 40 4000K

/## FINITURA/FINISHING

- 01 bianco | white
- 60 corten | corten
- 99 grafite | graphite

COMPOSIZIONE CODICE: xxx.X ● /##

HOW TO CREATE THE CODE: F1000.8 27 /01

CODE
F1000.8 ● /## — finishing
 base code kelvin

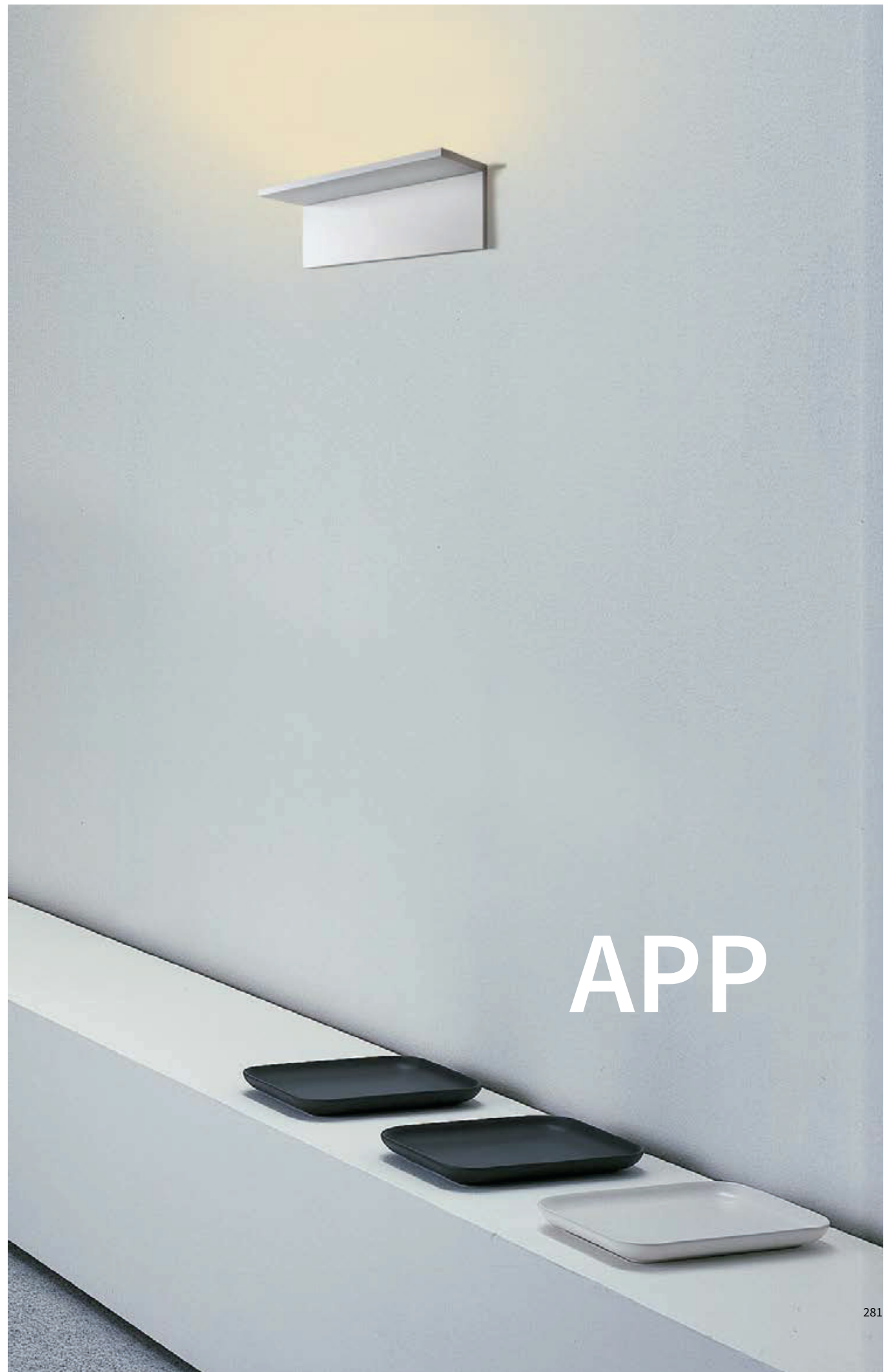

APP

APP

Applique architettonica a sorgente LED lineare. Caratterizzata da dimensioni ultraminimali, installata diventa parte integrante dell'architettura. App-line, una piccola mensola con emissione luminosa indiretta. App-eal, una "L", con emissione luminosa indiretta. Corpo in alluminio pieno lavorato, finitura verniciata. Gruppo ottico completo di schermo di protezione satinato. Grado di protezione IP40.

Architectural wall light with linear LED light source. Characterized by ultraminimal dimensions, installed it becomes an integral part of the architecture. App-line, a small shelf with indirect light emission. App-eal, an "L" with indirect light emission. Full machined aluminum body, painted finish. Optical unit complete with satin protection screen. IP40.



UK CONFORMITY ASSESSMENT E EUROPEAN CERTIFICATION / UK CONFORMITY ASSESMENT AND EUROPEAN CERTIFICATION



PRODOTTI COSTRUITI CON MATERIALE RICICLABILE / PRODUCTS MADE OF RECYCLABLE MATERIAL



GARANZIA DI 5 ANNI / 5-YEAR WARRANTY

FINITURE/FINISHINGS



01-BIANCO/WHITE



02- NERO/BLACK



49- BRONZO/BRONZE

FINITURE PREMIUM /PREMIUM FINISHINGS



81-ORO ROSA/
PINK GOLD



82-BRONZO
ANTICATO/
ANTIQUE
BRONZE



83-OTTONE BRUNITO
SPAZZOLATO/BRUSHED
BURNISHED BRASS

CURVE FOTOMETRICHE/PHOTOMETRIC DATA

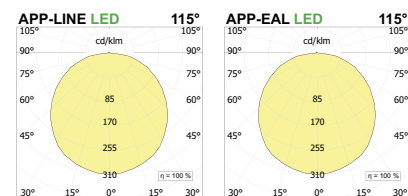

VERSIONI DISPONIBILI/AVAILABLE VERSION

- KELVIN
- 27 2700K
- 30 3000K
- 35 3500K
- 40 4000K

FASCIO/BEAM

115°

/## FINITURA/FINISHING

- /01 bianco | white
- /02 nero | black
- /49 bronzo | bronze

COMPOSIZIONE CODICE: xxx.x ● /##

HOW TO CREATE THE CODE: F1000.827/01

CODE
F1000.8 ● /## — finishing
base code kelvin

DRIVERS VEDI | SEE P. 452

APP-LINE 1

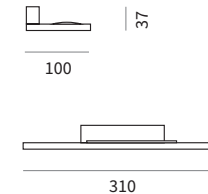

VERSIONE 230V

LED	Dim.	H	Kg	k	lm product/beam 3000K	CODE
12	100x310	37	1	3000	940	APS01/##
12	100x310	37	1	4000	960	APS02/##

Alimentatore dimmerabile a taglio di fase incluso per dimmer dedicati tipo Vimar EvoEikon od equivalenti. Phase cut driver, to be used with Vimar EvoEikon or equivalent dimmers, included

VERSIONE 400 mA

LED	Dim.	H	Kg	K	lm product/beam 3000K	CODE
10	100x310	37	1	1300		APS03.9 ● /##

Alimentatore non incluso, possibilità di abbinare driver On- off, Dali touch & Dimm, Dali 1-10V. Driver not included, it can be used with On- off, Dali touch & Dimm, Dali 1-10V dimmers.

APP-LINE 2

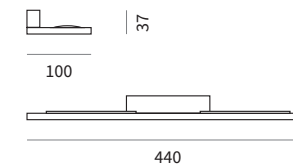

VERSIONE 230V

LED	Dim.	H	Kg	K	lm product/beam 3000K	CODE
23	100x440	37	1,30	3000	1880	APSB1/##
23	100x440	37	1,30	4000	1920	APSB2/##

Alimentatore dimmerabile a taglio di fase incluso per dimmer dedicati tipo Vimar EvoEikon od equivalenti. Phase cut driver, to be used with Vimar EvoEikon or equivalent dimmers, included

VERSIONE 400 mA

LED	Dim.	H	Kg	K	lm product/beam 3000K	CODE
19	100x440	37	1,30	2600		APSB3.9 ● /##

Alimentatore non incluso, possibilità di abbinare driver On- off, Dali touch & Dimm, Dali 1-10V. Driver not included, it can be used with On- off, Dali touch & Dimm, Dali 1-10V dimmers.

APP-EAL 1

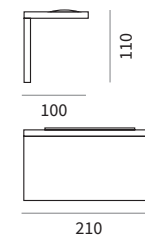

VERSIONE 230V

LED	Dim.	H	Kg	K	lm product/beam 3000K	CODE
12	100x210	110	1,2	3000	940	APE01/##
12	100x210	110	1,2	4000	960	APE02/##

Alimentatore dimmerabile a taglio di fase incluso per dimmer dedicati tipo Vimar EvoEikon od equivalenti. Phase cut driver, to be used with Vimar EvoEikon or equivalent dimmers, included

VERSIONE 400 mA

LED	Dim.	H	Kg	K	lm product/beam 3000K	CODE
10	100x210	110	1,2	1300		APE03.9 ● /##

Alimentatore non incluso, possibilità di abbinare driver On- off, Dali touch & Dimm, Dali 1-10V. Driver not included, it can be used with On- off, Dali touch & Dimm, Dali 1-10V dimmers.

APP-EAL 2

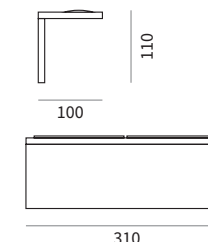

VERSIONE 230V

LED	Dim.	H	Kg	K	lm product/beam 3000K	CODE
23	100x310	110	1,5	3000	1880	APEB1/##
23	100x310	110	1,5	4000	1920	APEB2/##

Alimentatore dimmerabile a taglio di fase incluso per dimmer dedicati tipo Vimar EvoEikon od equivalenti. Phase cut driver, to be used with Vimar EvoEikon or equivalent dimmers, included

VERSIONE 400 mA

LED	Dim.	H	Kg	K	lm product/beam 3000K	CODE
19	100x310	110	1,5	2600		APEB3.9 ● /##

Alimentatore non incluso, possibilità di abbinare driver On- off, Dali touch & Dimm, Dali 1-10V. Driver not included, it can be used with On- off, Dali touch & Dimm, Dali 1-10V dimmers.

INDOOR - Mini Track system & projectors

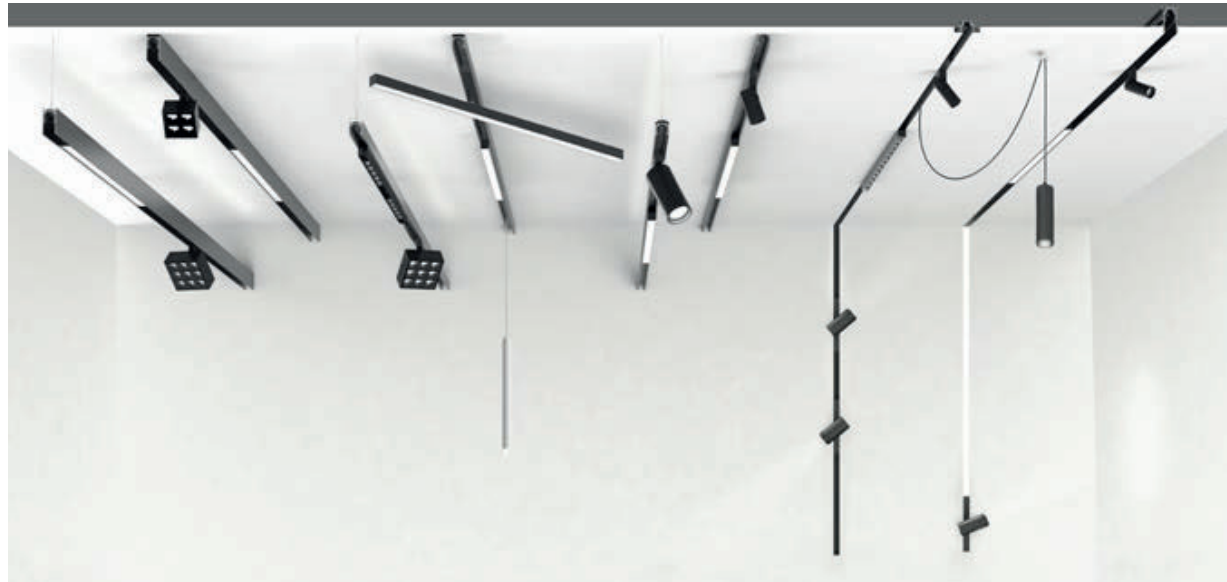

MICROFILE P.298



LEVA P.300 NEW



LEVA QUADRA P.302

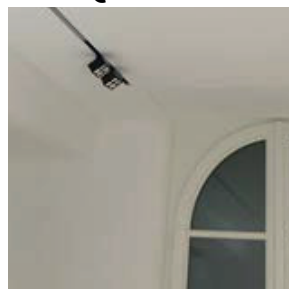

IRIDE P.303



FOCUS P.304



IPIPEDI P.306 NEW



GRID P.315 NEW

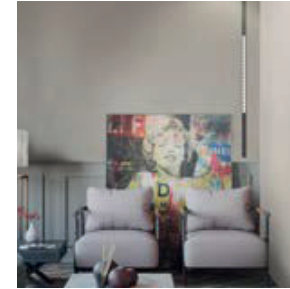

MINIGRID P.316 NEW

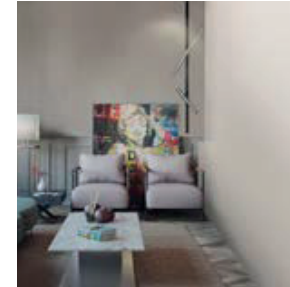

CUBOTTI PAGINA 318 NEW

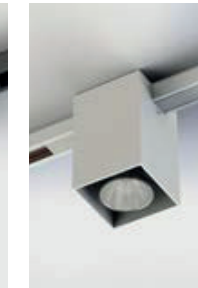
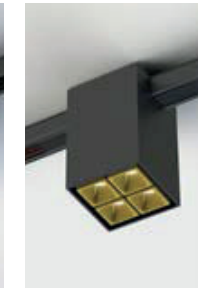
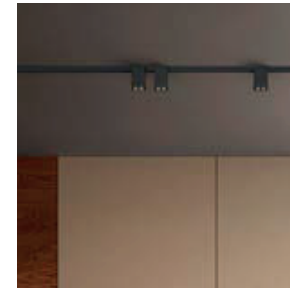

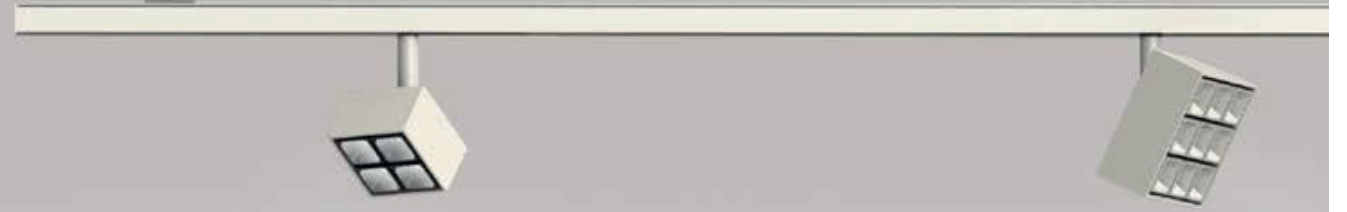

MINI TRACK

& PROJECTORS

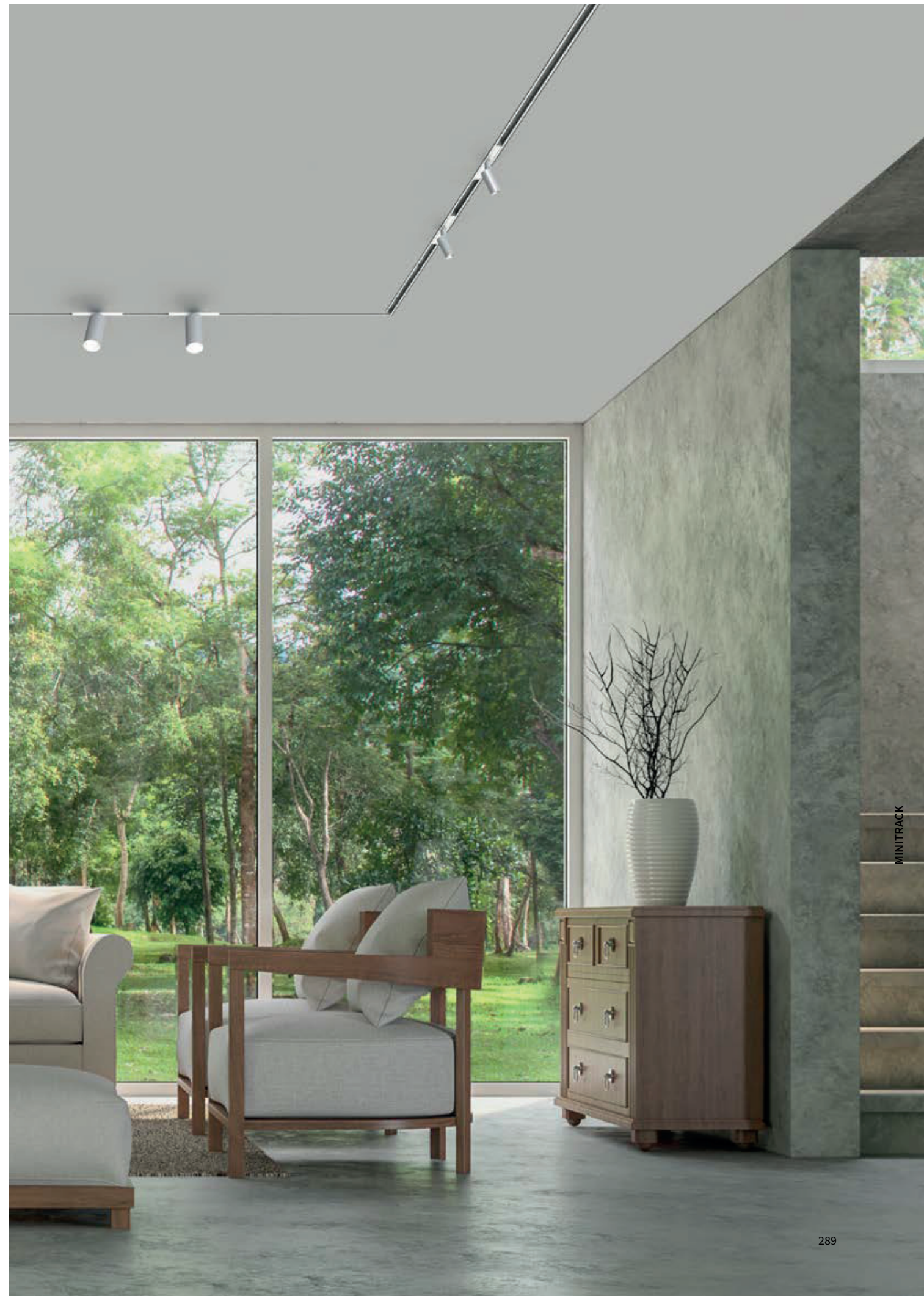
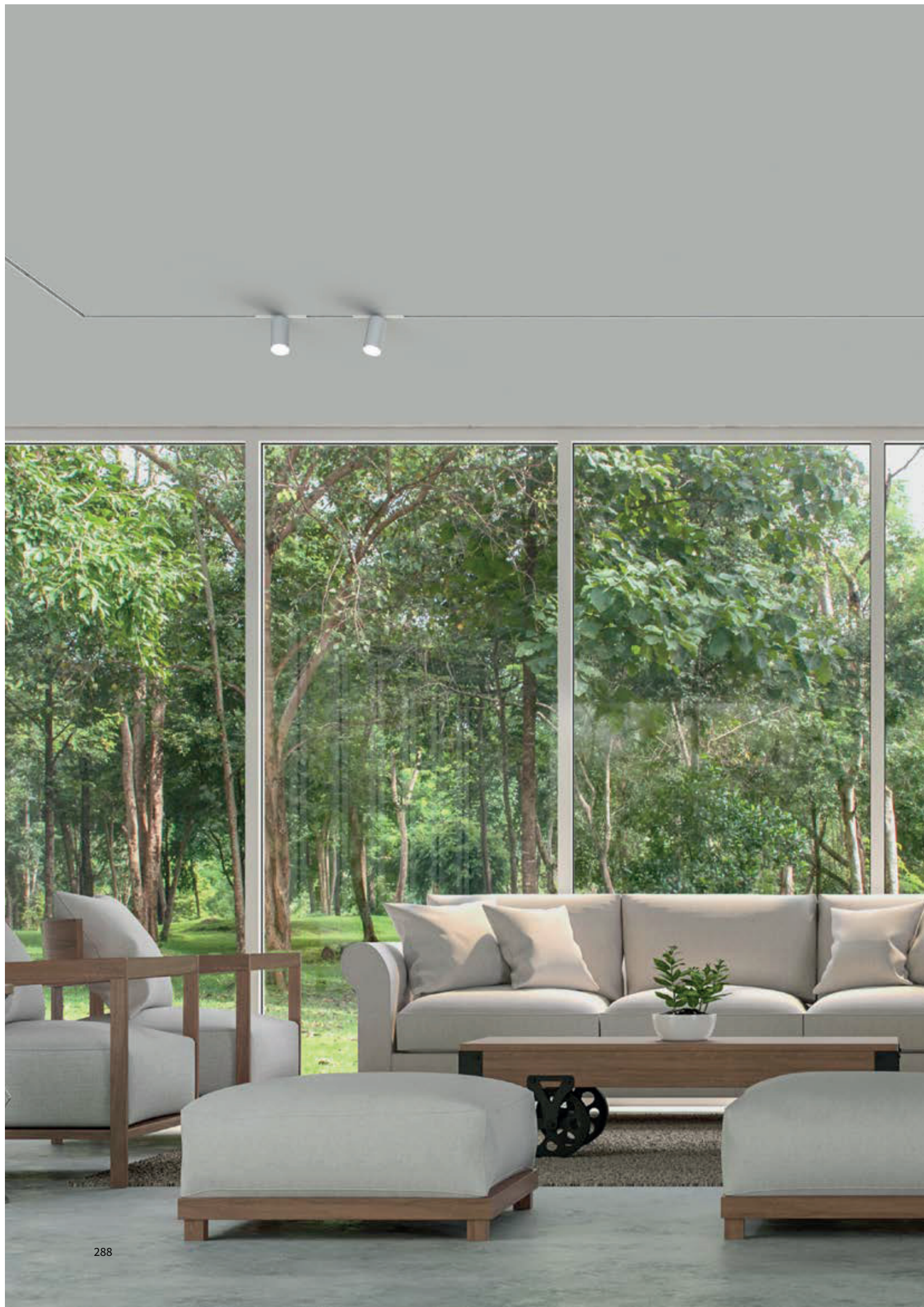

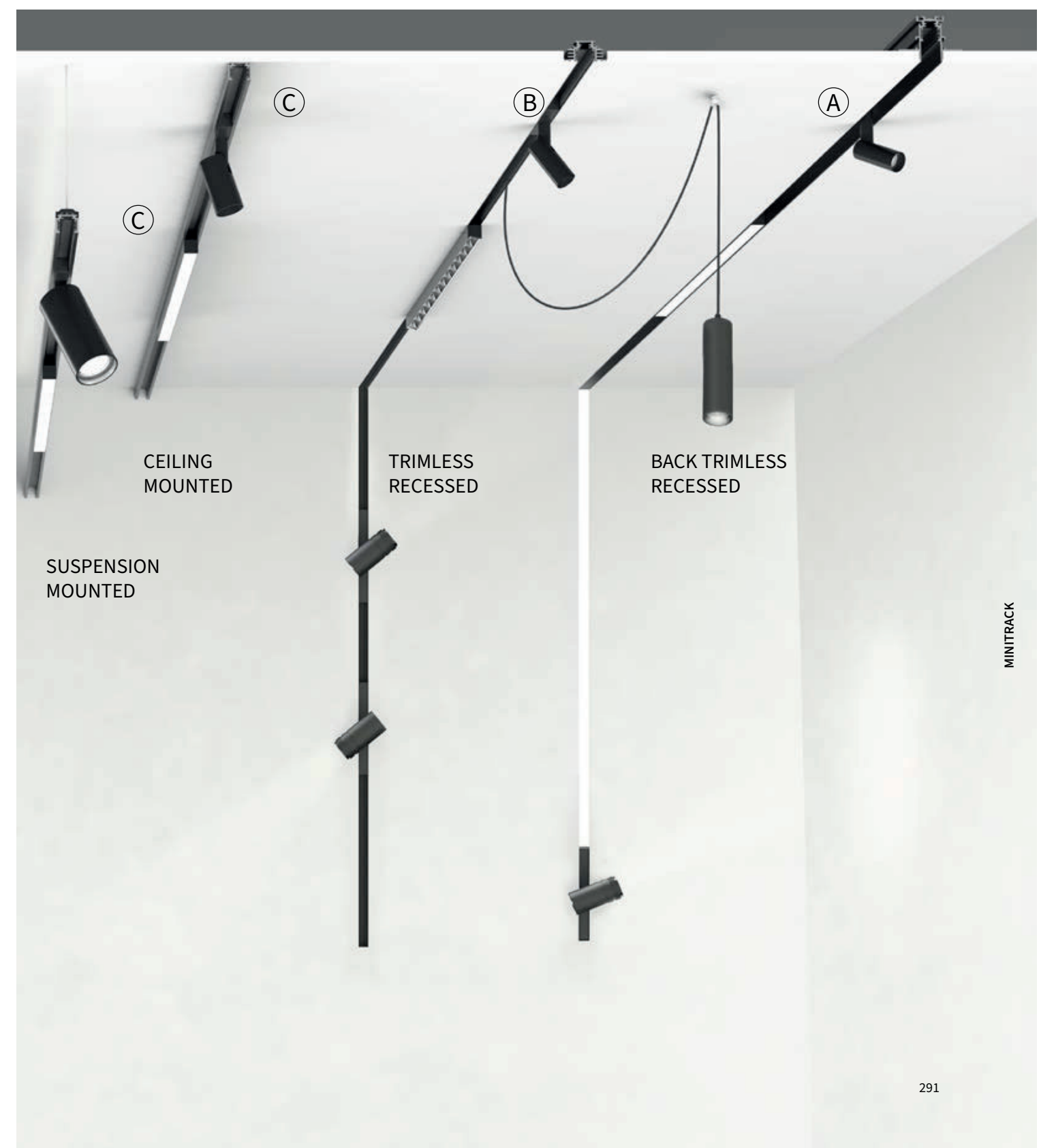
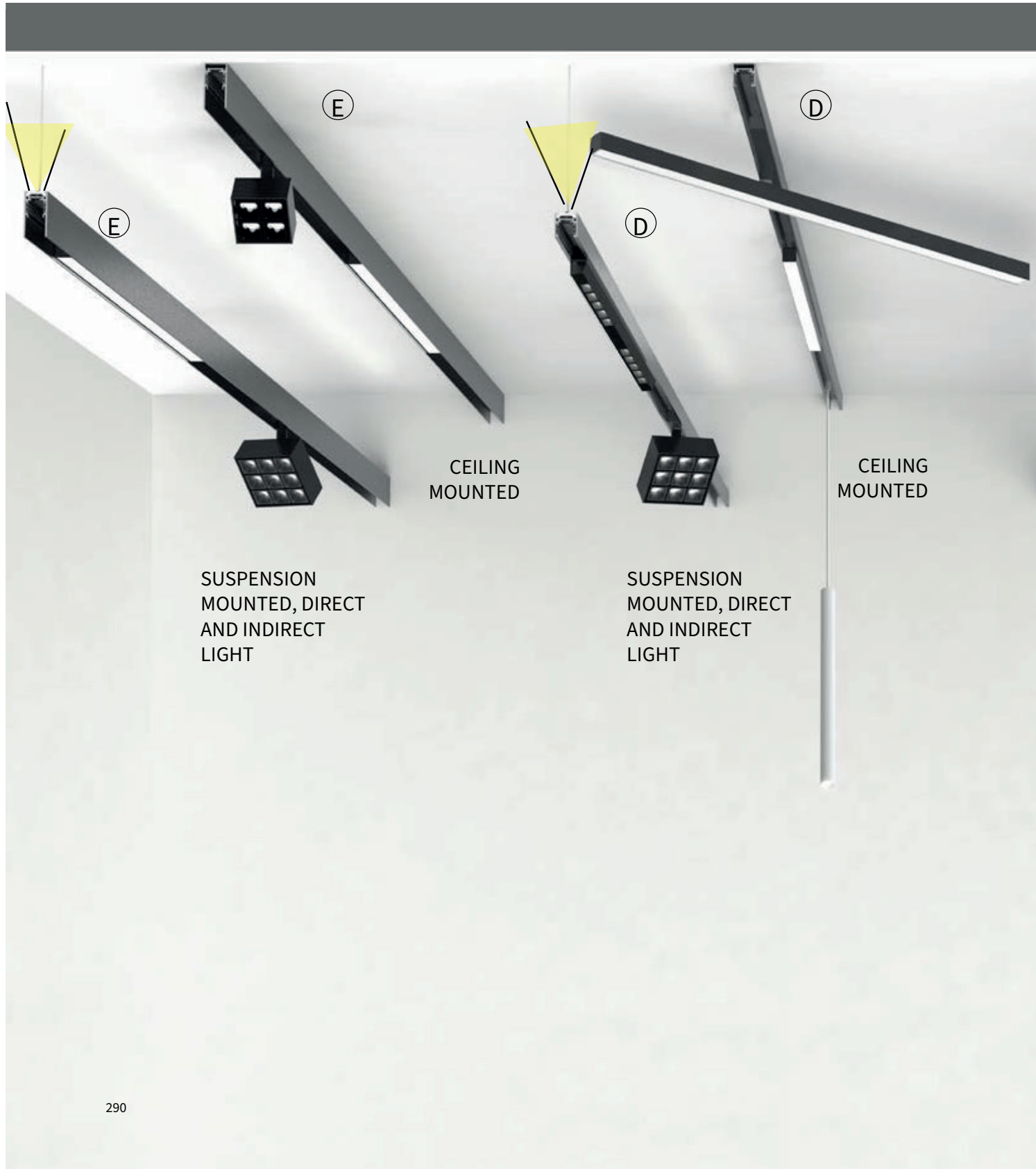
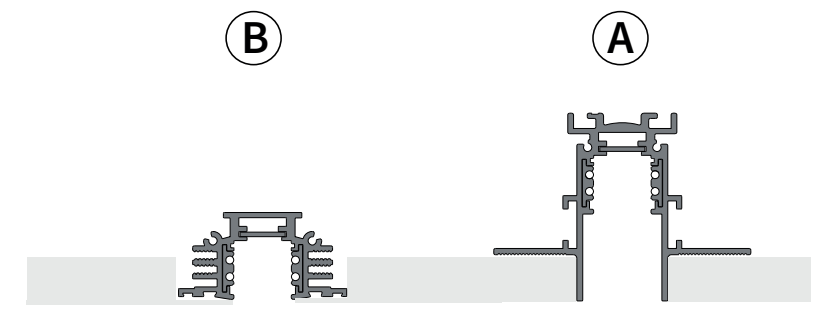
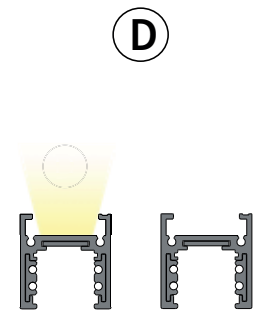
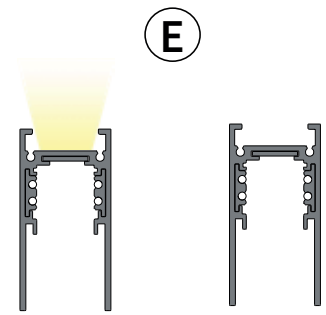

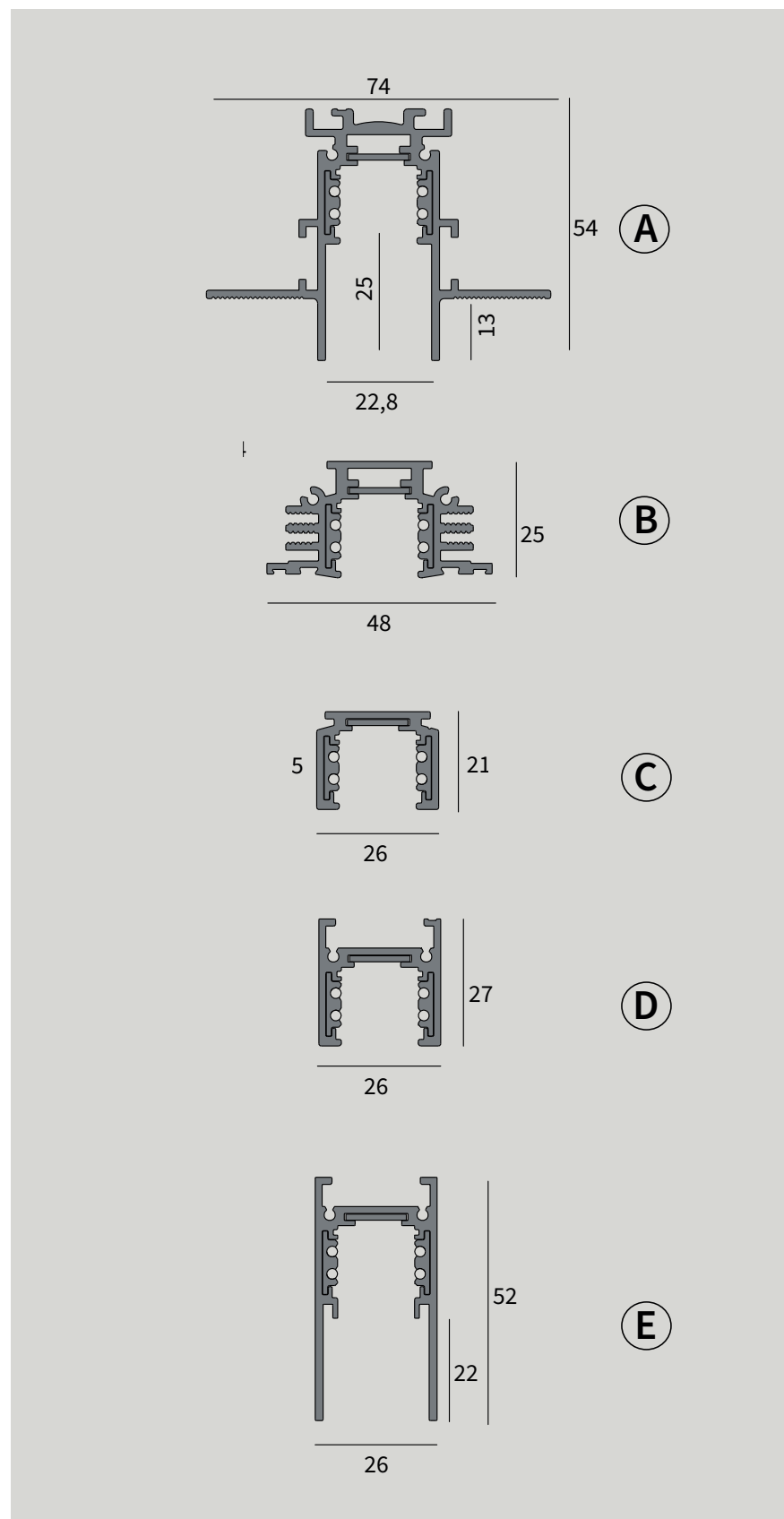

MINITRACK

Il binario Mini Track è un binario elettrificato in Classe III-SELV con due circuiti: uno per una alimentazione a bassa tensione 24/48V e l'altra per il DATA BUS (DALI o 1-10V). La tensione di alimentazione può essere a 24V o 48V a seconda dei modelli di corpi illuminanti prescelti e la corrente di alimentazione non deve essere superiore ai 15A. Nelle versioni a soffitto o a sospensione sono disponibili le finiture bianca e nera mentre nelle versioni da incasso solamente quella nera. I corpi illuminanti proposti possono essere utilizzati su binari elettrificati a 24V o 48V, tranne gli articoli della famiglia microfile che necessitano esclusivamente il 24V. I faretto dimmerabili DALI sono equipaggiati con converter non polarizzati che permettono l'innesco in qualsiasi verso, e tecnologia Hot Plug per l'inserimento in sicurezza con binario in tensione.

The Mini Track track is an electrified Class III-SELV track with two circuits: one for a low voltage 24/48V power supply and the other for the DATA BUS (DALI or 1-10V). The power supply voltage can be 24V or 48V, not exceeding 15A, depending on the models of lighting fixtures chosen. White and black finishes are available in the ceiling and suspended versions, while only the black finishing for the recessed option. The lighting fixtures can be used on both 24V or 48V electrified tracks, except the microfile family that requires only 24V. DALI dimmable spotlights are equipped with non-polarized converters that allow to be installed in any direction, and Hot Plug technology for safe insertion with live track.



UK CONFORMITY ASSESSMENT E EUROPEAN CERTIFICATION / UK CONFORMITY ASSESSMENT AND EUROPEAN CERTIFICATION



PRODOTTI COSTRUITI CON MATERIALE RICICLABILE / PRODUCTS MADE OF RECYCLABLE MATERIAL



GARANZIA DI 5 ANNI / 5-YEAR WARRANTY



SU RICHIESTA GESTIONE BLUETOOTH / UPON REQUEST BLUETOOTH MANAGEMENT





VERSIONI DISPONIBILI/AVAILABLE VERSION

FINITURA/FINISHING

- /01 bianco | white
- /02 nero | black

COMPOSIZIONE CODICE: xxx.x /##

HOW TO CREATE THE CODE: **F1000/01**

CODE
F1000 /## — finishing
 |
 base code

MINI TRACK 24/48V INCASSO RASATO ARRETRATO 24/48V BACK RECESSED TRACK MODULE

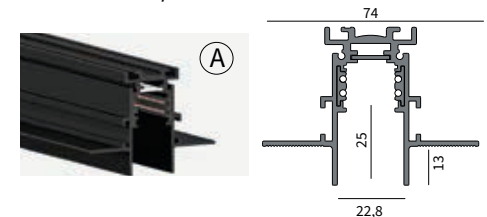

Dim. mm	Lmm	CODE
	1000	LT9301/##
74x54	2000	LT9302/##
	3000	LT9303/##

Da completare con gli accessori | To complete with accessories*

MINI TRACK 24/48V INCASSO RASATO 24/48V RECESSED TRACK MODULE

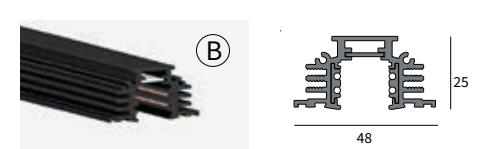

Dim. mm	Lmm	CODE
	1000	LT9201/##
48x25	2000	LT9202/##
	3000	LT9203/##

Da completare con gli accessori | To complete with accessories*

MINI TRACK 24/48V SOFFITTO 24/48V TRACK MODULE



Dim. mm	Lmm	CODE
	1000	LT9101/##
28x21	2000	LT9102/##
	3000	LT9103/##

Da completare con gli accessori | To complete with accessories*

MINI TRACK 24/48V BIEMISSIONE 24/48V BIEMISSION TRACK MODULE



Dim. mm	Lmm	CODE
	1000	LT9401/##
26x27	2000	LT9402/##
	3000	LT9403/##

Da completare con gli accessori | To complete with accessories*

MINI TRACK 24/48V BIEMISSIONE ARRETRATA 24/48V BACK BIEMISSION TRACK MODULE



Dim. mm	Lmm	CODE
	1000	LT9501/##
26x52	2000	LT9502/##
	3000	LT9503/##

Da completare con gli accessori | To complete with accessories*

*È vietato utilizzare alimentatori, driver, sistemi Bus Dati e componenti non omologati SELV e/o che abbiano una U-OUT maggiore di 60 V dc - Lucifero's raccomanda l'utilizzo di un ripetitore optoisolato DALI compatibile. The use of NON SELV or U-OUT > 60V dc power supplies, drivers and components is strictly forbidden. - Lucifero's recommends the usage of an opto-insulated repeater DALI compatible.

TAPPO DI CHIUSURA PER PROFILO LT91## SOFFITTO/SOSPENSIONE BLIND END FOR CODE LT91## WALL/CEILING MOUNTING

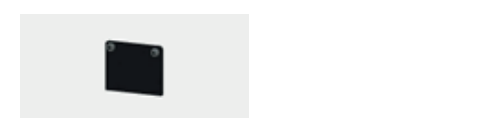

profilo/profile	CODE
(C)	LT9110/##

Ordinare almeno 2 pezzi | To order minimum 2 pcs

TAPPO DI CHIUSURA PER PROFILO LT92## INCASSO RASATO RECESSED TRACKS BLIND END FOR CODE LT92## TRIMLESS RECESSED MOUNTING

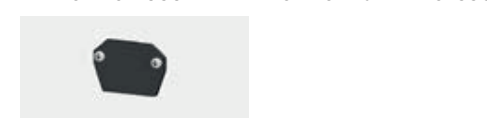

profilo/profile	CODE
(B)	LT9210/02

Ordinare almeno 2 pezzi | To order minimum 2 pcs

TAPPO DI CHIUSURA PER PROFILO LT93## E LT95## ARRETRATO BACK RECESSED TRACK BLIND END

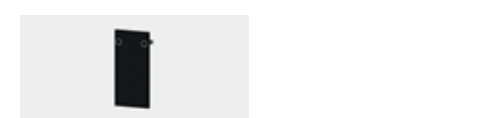

profilo/profile	CODE
(A) (E)	LT9310/02

Ordinare almeno 2 pezzi | To order minimum 2 pcs

TAPPO DI CHIUSURA PER PROFILO LT94## BIEMISSIONE BIEMISSION TRACK BLIND END



profilo/profile	CODE
(D)	LT9410/##

Ordinare almeno 2 pezzi | To order minimum 2 pcs

TESTATA NON POLARIZZATA NON-POLARIZED HEAD

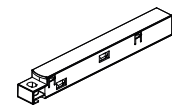

24V 48V CE
CODE
LT9120/##

GIUNTO LINEARE NON POLARIZZATO NOT POLARIZED CONNECTOR FOR TRACK SYSTEM

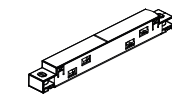

24V 48V CE
CODE
LT9123/##

GIUNTO ANGOLARE NON POLARIZZATO NOT POLARIZED ANGLE CONNECTOR FOR TRACK SYSTEM



24V 48V CE
CODE
LT9126/##
Richiede taglio profilo a 45° | Necessary cut 45° in the profile

COPIA DI STAFFE DI FISSAGGIO BINARIO INCASSO RASATO COUPLE OF FLUSH MOUNTING BRACKET FOR RECESSED TRACK

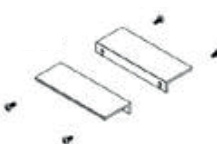

profilo/profile
A B
CODE
LT9211
**Una ogni (vedi immagini sotto con indicazione del carico) | One every (see the image below with the indication of load)

GIUNTO MECCANICO DI UNIONE BINARIO INCASSO E INCASSO ARRETRATO REINFORCEMENT BRACKET FOR DIRECT RECESSED AND RECESSED FLUSH MOUNTING

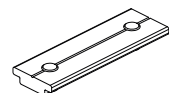

profilo/profile
A B
CODE
LT9212/02

GIUNTO 90 SOLO PER LT94** E LT95** 90° JOINT ONLY FOR LT94** AND LT95**



profilo/profile
D E
CODE
LT9346/02
Richiede taglio profilo a 45° | Necessary cut 45° in the profile

ALIMENTATORE PER BINARIO POWER SUPPLY FOR MINI TRACK

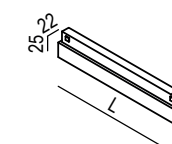

	W	Lmm	CODE
48VDC	100	247	LT92.100
48VDC	200	317	LT92.200

GIUNTO MECCANICO DI UNIONE PER BINARIO SOSPENSIONE REINFORCEMENT BRACKET FOR SUSPENSION

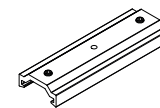

profilo/profile
A
CODE
LT9112

STAFFA DI FISSAGGIO BIEMISSIONE FLUSH MOUNTING BRACKET FOR BIEMISSION TRACK

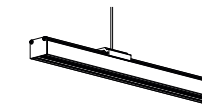
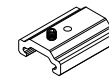

profilo/profile
D E
CODE
LT9411
**Per la quantità da ordinare vedi immagine sotto con indicazione del carico | For the quantity see the image below with the indication of load

STAFFA PER SOSPENSIONE SUSPENSION HANGER

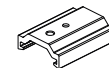

profilo/profile
C D E
CODE
LT9111/##
**Per la quantità da ordinare vedi immagine sotto con indicazione del carico | For the quantity see the image below with the indication of load

SOSPENSIONE CON CAVO DI ACCIAIO STEEL SUSPENSION CABLE- JUNTA DE SUSPENSION CON ALIMENTADOR

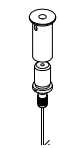

profilo/profile	Lmm	CODE
C D E	2000	LT9036.1
C D E	4000	LT9036.1.4

**Per la quantità da ordinare vedi immagine sotto con indicazione del carico | For the quantity see the image below with the indication of load

DIFFUSORE INDIRETTO IN POLICARBONATO OPALINO / INDIRECT OPAL WHITE POLYCARBONATE DIFFUSER



Lmm	Kg	CODE
1000	0.16	LT94P.1000
2000	0.33	LT94P.2000
3000	0.50	LT94P.3000

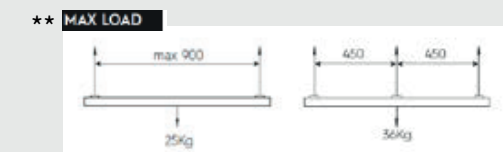

DRIVER DA ABBINARE REMOTO REMOTE POWER SUPPLY

CODE	On/Off	Dali	Push & Dimm	1-10V	I	Vin	Vout range	W	LXPxH (mm)	Ø (mm)	IP
48V AE100.48V	●				0	90-264V	48V	100	200,5x69,5x39	80	20
AE50.48V	●				0	220-240V	48	50	225x60x36	70	20

VERSIONI DISPONIBILI/AVAILABLE VERSION

FINITURA/FINISHING

- /01 bianco | white
- /02 nero | black

COMPOSIZIONE CODICE: xxx.x /##
HOW TO CREATE THE CODE: F1000/01

CODE
F1000 /## — finishing
|
base code

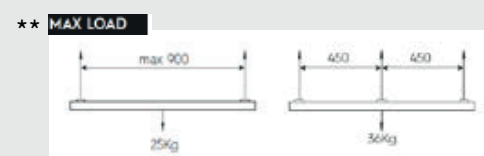



MICROFILE

MINI TRACK



STANDARD

ARRETRATO
DEEP RECESSED

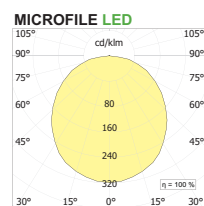

VERSIONI DISPONIBILI/AVAILABLE VERSION

- KELVIN**
- 27 2700K
- 30 3000K
- 35 3500K
- 40 4000K
- TW Tunable White Dali

- DIMMABLE (OPTIONAL)**
- D Dali Touch & Dimm

- FINITURA/FINISHING**
- /01 bianco | white
- /02 nero | black

Per la versione Dali scegliere un alimentatore ON OFF da posizionare remotamente.
For Dali version combine a ON OFF power supply to place remotely

Su richiesta gestione Bluetooth
Upon request Bluetooth management

COMPOSIZIONE CODICE: xxx.x ●●/##
HOW TO CREATE THE CODE: F1000.827D/01

CODE
F1000.8 ● ● /## — finishing
base code kelvin dimmable

MICROFILE MINI TRACK / MICROFILE MINI TRACK

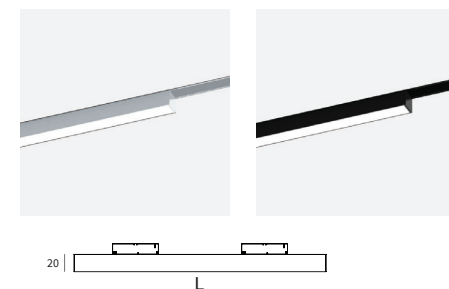

24V LED P40 CRI >90 A 5 UK CE

W	Lmm	lm prod 3000K	CODE
19,8	925	980	MF101.8 ○/##
26,4	1220	1290	MF102.8 ○/##
33	1515	1600	MF103.8 ○/##

TW 48V LED P40 CRI >90 A 5 UK CE

W	Lmm	lm prod 3000K	CODE
19,8	950	1280	MF111.8 ●●/##
26,4	1262	1700	MF112.8 ●●/##
33	1515	2040	MF113.8 ●●/##

Binario (LT91, LT92, LT94) da ordinare separatamente | Track system (LT91, LT92, LT94) to be ordered separately.
TYPE A C D

MICROFILE TRACK ARRETRATO MICROFILE DEEP RECESSED TRACK

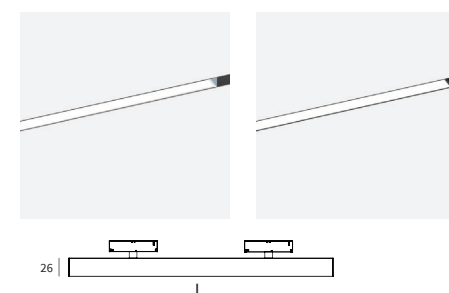

24V LED P40 CRI >90 A 5 UK CE

W	Lmm	lm prod 3000K	CODE
19,8	925	980	MF201.8 ○/##
26,4	1220	1290	MF202.8 ○/##
33	1515	1600	MF203.8 ○/##

TW 48V LED P40 CRI >90 A 5 UK CE

W	Lmm	lm prod 3000K	CODE
19,8	950	1280	MF211.8 ●●/##
26,4	1262	1700	MF212.8 ●●/##
33	1515	2040	MF213.8 ●●/##

Binario (LT93, LT95) da ordinare separatamente | Track system (LT93, LT95) to be ordered separately.
TYPE B E

MICROFILE MINI TRACK SHANGHAI

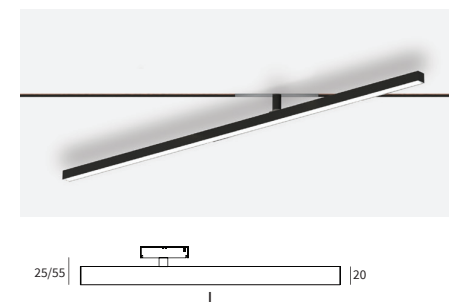

24V LED P40 CRI >90 A 5 UK CE

linear di luce - LED line

W	Lmm	H	lm product 3000K	CODE
19,8	925	55+ADAPTER	980	MF303.8 ○/##
26,4	1220	55+ADAPTER	1290	MF304.8 ○/##

TW 48V LED P40 CRI >90 A 5 UK CE

linear di luce - LED line

W	Lmm	H	lm product 3000K	CODE
19,8	925	55+ADAPTER	1280	MF313.8 ●●/##
26,4	1220	55+ADAPTER	1700	MF314.8 ●●/##

Binario (LT91, LT92, LT94) da ordinare separatamente | Track system (LT91, LT92, LT94) to be ordered separately.
MF303.8 e MF304.8 idonei anche per incasso arretrato - Suitable for deep recessed version also.
TYPE A C D



LEVA

MINI TRACK

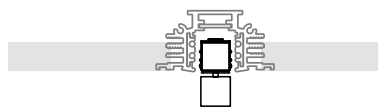
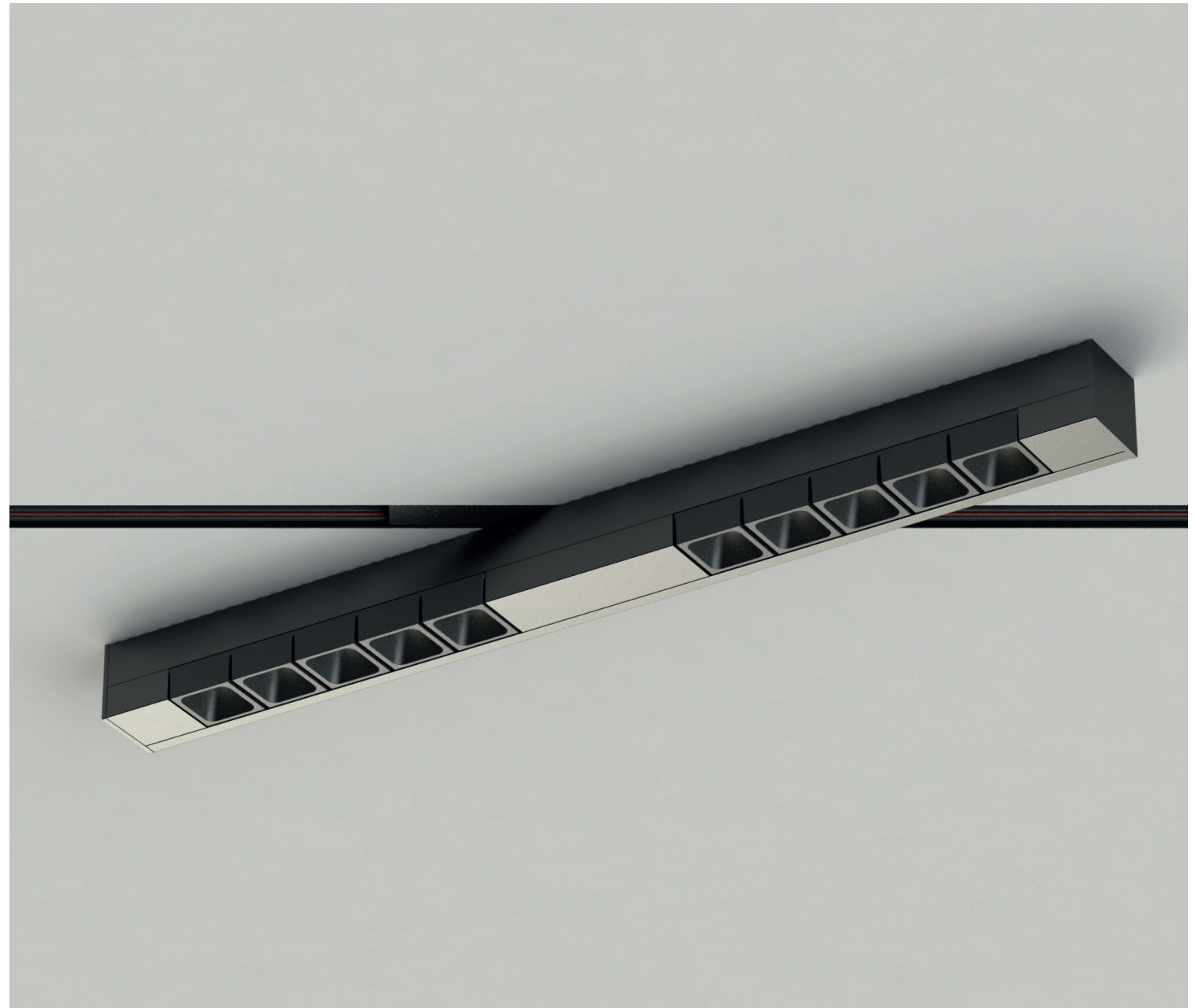

STANDARD

VERSIONI DISPONIBILI/AVAILABLE VERSION

- **KELVIN**
- 27 2700K
- 30 3000K
- 35 3500K
- 40 4000K
- TW Tunable White Dali

- **FASCIO/BEAM**
- Spot
- Flood
- Wide
- Asymmetric

- **DIMMABLE (OPTIONAL)**
- D Dali Touch & Dimm

Per la versione Dali scegliere un alimentatore ON OFF da posizionare remoto.
For Dali version combine a ON OFF power supply to place remotely

- ## **FINITURA/FINISHING**
- /01 telaio bianco, ottica nera | white frame, black optic
- /02 telaio nero, ottica nera | black frame, black optic
- /41 telaio bianco, ottica bianca | white frame, white optic
- /42 telaio nero, ottica oro | black frame, gold optic

DRIVERS VEDI | SEE "ALIMENTATORI" A PAGINA 452

LEVA 10 MINI TRACK

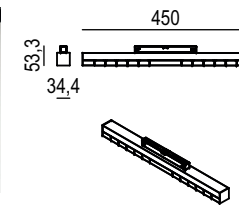
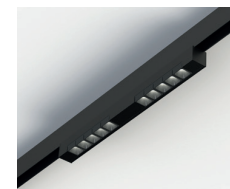

LED	W	Dim.	H	Kg	Im product/beam 3000K	CODE
22	32x310	62	0.66	20° 32° 50° 41°x18°	2004 1862 1656 1754	LV220.9 ●●/##

Binario (LT91, LT92, LT94) da ordinare separatamente | Track system (LT91, LT92, LT94) to be ordered separately.
TYPE A C D



LEVA QUADRA MINI TRACK

- **KELVIN**
- 27 2700K
- 30 3000K
- 35 3500K
- 40 4000K
- TW Tunable White

- **FASCIO/BEAM**

- S Spot
- F Flood
- W Wide

- **DIMMABLE (OPTIONAL)**

D Dali Touch & Dimm

I

Per la versione Dali scegliere un alimentatore ON OFF da posizionare remoto.

For Dali version combine a ON OFF power supply to place remotely

/## **FINITURA/FINISHING**

- /01 telaio bianco, ottica nera | white frame, black optic
- /02 telaio nero, ottica nera | black frame, black optic
- /41 telaio bianco, ottica bianca | white frame, white optic
- /42 telaio nero, ottica oro | black frame, gold optic

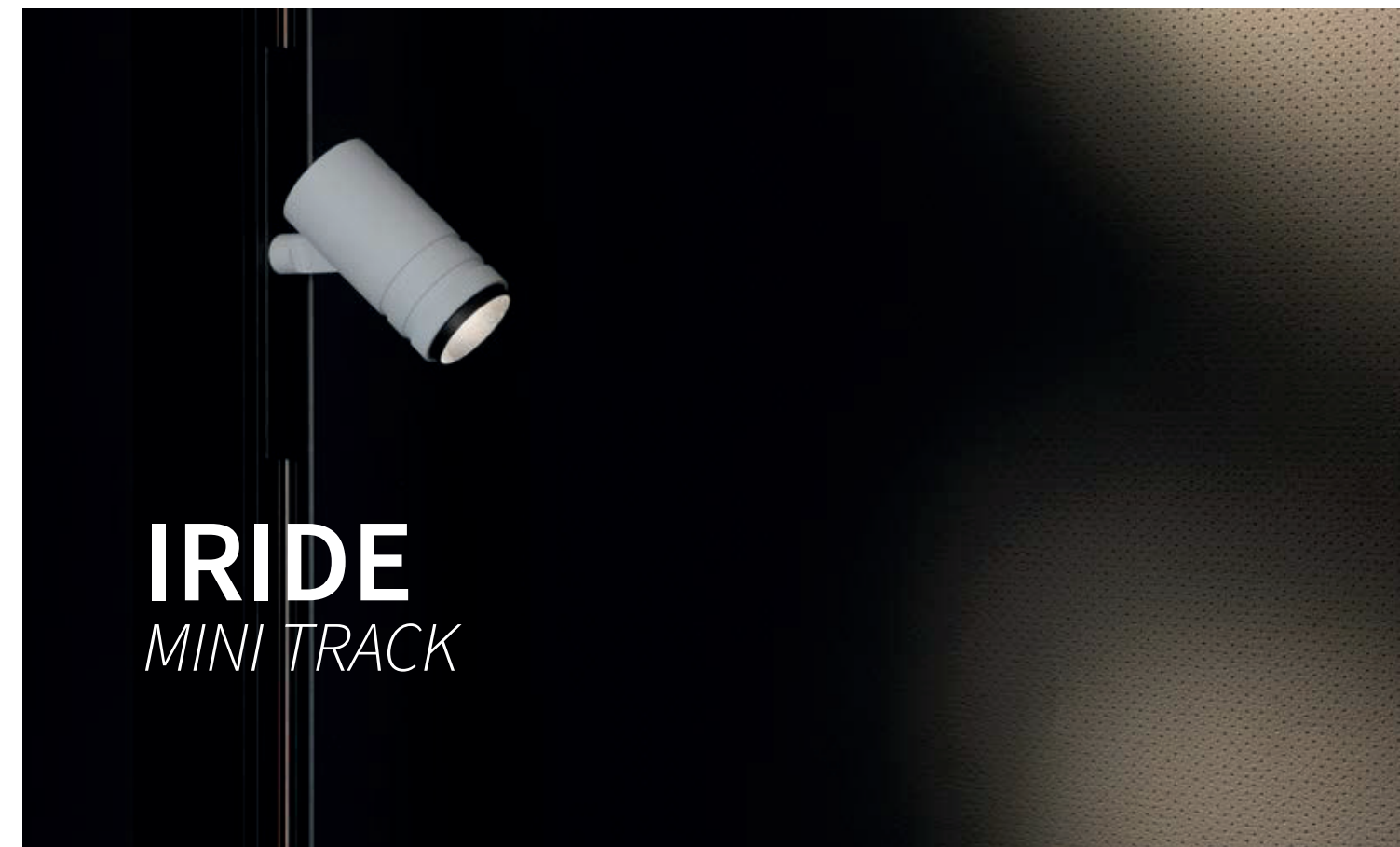

IRIDE MINI TRACK

LEVA QUADRA Q4 MINI TRACK

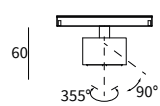

STANDARD

LED 24V e 48V				lm prod./beam 3000K				
W	Dim.	H	Kg	S20°	F32°	W50°	CODE	
8,8	68x68	60+adapter	0,60	800	745	662	LV321.9	●●●/##

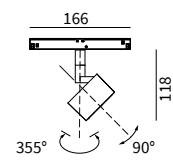

ARRETRATO DEEP RECESSED TRACK

LED 24V e 48V				lm prod./beam 3000K				
W	Dim.	H	Kg	S20°	F32°	W50°	CODE	
8,8	68x68	118+adapter	0,60	800	745	662	LV321A.9	●●●/##

LEVA QUADRA Q9 MINI TRACK

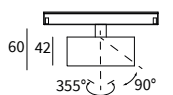

STANDARD

LED 48V				lm prod./beam 3000K				
W	Dim.	H	Kg	S20°	F32°	W50°	CODE	
19,8	98x98	60+adapter	0,90	1800	1676	1490	LV325.9	●●●/##

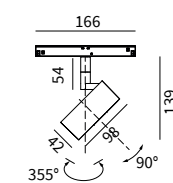

ARRETRATO DEEP RECESSED TRACK

LED 48V				lm prod./beam 3000K				
W	Dim.	H	Kg	S20°	F32°	W50°	CODE	
19,8	98x98	139+adapter	0,90	1800	1676	1490	LV325A.9	●●●/##

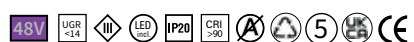
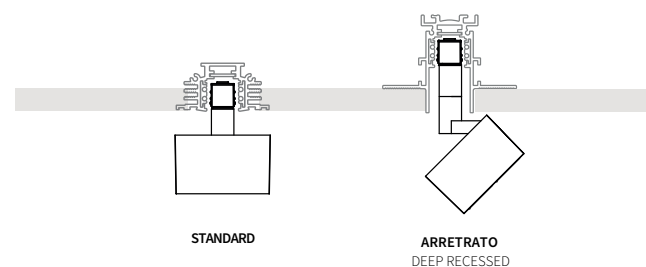

IRIDE MINI TRACK 43L

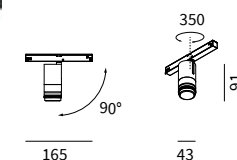

LED 24V e 48V				lm product/beam 3000K				
W	∅	H	Kg	S20°	F32°	W50°	CODE	
6,7	43	742	0,01	800	745	662	IR08.9	●●●/##

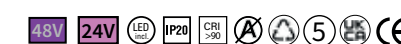

ACCESSORI / ACCESSORIES



LENTE OPZIONALE / OPTIONAL LENS					
∅	H	Kg	CODE		
43	0,01	0,01	L043R		



- **KELVIN**
- 27 2700K
- 30 3000K
- 35 3500K
- 40 4000K

- **FASCIO/BEAM**

- W Wide 39°

- **DIMMABLE (OPTIONAL)**

D Dali Touch & Dimm

Per la versione Dali scegliere un alimentatore ON OFF da posizionare remoto.
For Dali version combine a ON OFF power supply to place remotely

/## **FINITURA/FINISHING**

- /01 bianco | white
- /02 nero | black
- /21 bianco, anello cromo | white, chrome ring
- /25 nero, anello cromo | black, chrome ring
- /28 bianco, anello nero | white, black ring

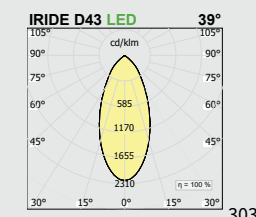



FOCUS MINI TRACK

VERSIONI DISPONIBILI/ AVAILABLE VERSION

● KELVIN

- 27 2700K
- 30 3000K
- 35 3500K
- 40 4000K

● FASCIO/BEAM

- S Spot
- F Flood
- Z Asymmetric

○ FASCIO/BEAM

- F Flood
- W Wide

Per i gradi vedi in tabella. For degree check the table.

● DIMMABLE (OPTIONAL)

- D Dali Touch & Dimm

Per la versione Dali scegliere un alimentatore ON OFF da posizionare remoto.
For Dali version combine a ON OFF power supply to place remotely

/ ## FINITURA/FINISHING

- /01 bianco | white
- /02 nero | black
- /03 cromo | chrome

48V DRIVERS VEDI | SEE "ALIMENTATORI" A PAGINA 45

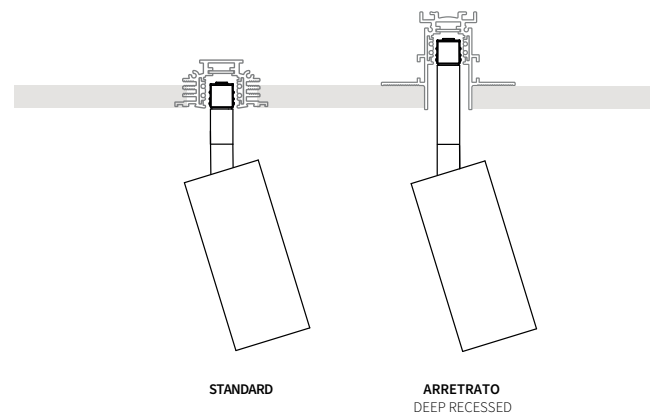

ACCESSORI / ACCESSORIES

LENTI / LENSES		Kg	Ø	CODE	Ø	CODE	Ø	CODE	Col.
	LENTE SATINATA / SATINED LENS	0,01	26	L026S.A/	36	L036S.A/	55	L055S.A/	01-02
	LENTE ELISSOIDALE / ELIPSOID LENS	0,01	26	L026E.A/	36	L036E.A/	55	L055E.A/	01-02
	LENTE ASIMMETRICA / ASYMMETRIC LENS	0,01	26	L026A.A/	36	L036A.A/	55	L055A.A/	01-02
	FILTRO NIDO DAPE / HONEYCOMB LOUVER	0,01	26	L026R.A/	36	L036R.A/	55	L055R.A/	01-02

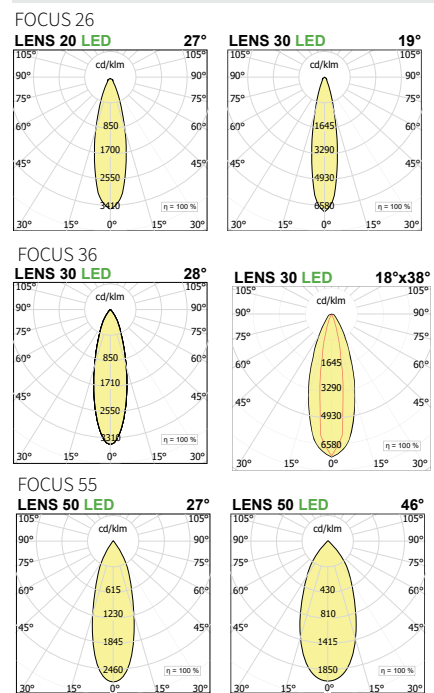

FOCUS T26 MINI TRACK 24/48V



FOCUS T36 MINI TRACK 24/48V



FOCUS T55 MINI TRACK 24/48V



FOCUS 2T26 MINI TRACK 48V



FOCUS 2T36 MINI TRACK 48V



STANDARD

LED 48V	W	Ømm	Hmm	Lmm	F27°	Im product/beam 3000K	CODE
	5,7	26	85	166	571		FS501.9 ● F ● /##

● Disponibile solo fascio F | Available only F beam

ARRETRATO DEEP RECESSED TRACK

LED 48V	W	Ømm	Hmm	Lmm	F27°	Im product/beam 3000K	CODE
	5,7	26	110	166	571		FS501A.9 ● F ● /##

● Disponibile solo fascio F | Available only F beam

STANDARD

LED 48V	W	Ømm	Hmm	Lmm	S19°	F25°	Z18°x38°	CODE
	8	36	92	166	665	695	508	FS502.9 ● ● ● /##

ARRETRATO DEEP RECESSED TRACK

LED 48V	W	Ømm	Hmm	Lmm	S19°	F25°	Z18°x38°	CODE
	8	36	117	166	665	695	508	FS502A.9 ● ● ● /##

STANDARD

LED 48V	W	Ømm	Hmm	Lmm	F27°	W46°	Im product/beam 3000K	CODE
	12,7	55	138	166	1285	1289		FS504.9 ● ● ● /##
	18,5	55	138	166	1575	1579		FS503.9 ● ● ● /##

● Disponibili solo fascio F, W | Available only F, W beam

ARRETRATO DEEP RECESSED TRACK

LED 48V	W	Ømm	Hmm	Lmm	F27°	W46°	Im product/beam 3000K	CODE
	12,7	55	162	166	1285	1289		FS504A.9 ● ● ● /##
	18,5	55	162	166	1575	1579		FS503A.9 ● ● ● /##

● Disponibili solo fascio F, W | Available only F, W beam

Accessori - accessories: L055#.A: Anello Ø55 + lente - lens with ring Ø55



STANDARD

LED 48V	W	Ømm	Hmm	Lmm	F27°	Im product/beam 3000K	CODE
	2 x 6,2	26	85	166	1142		FS551.9 ● F ● /##

ARRETRATO DEEP RECESSED TRACK

LED 48V	W	Ømm	Hmm	Lmm	F27°	Im product/beam 3000K	CODE
	2 x 6,2	26	110	166	1142		FS551A.9 ● F ● /##

STANDARD

LED 48V	W	Ømm	Hmm	Lmm	S19°	F25°	Z18°x38°	Im product/beam 3000K	CODE
	2 x 8,7	36	92	166	1330	1390	1016		FS552.9 ● ● ● /##

ARRETRATO DEEP RECESSED TRACK

LED 48V	W	Ømm	Hmm	Lmm	S19°	F25°	Z18°x38°	Im product/beam 3000K	CODE
	2 x 8,7	36	117	166	1330	1390	1016		FS552A.9 ● ● ● /##



IPIPEDI MINI TRACK

ACCESSORI / ACCESSORIES

LENTI / LENSES Ø 55



	Ø	Kg	CODE	Col.
LENTE SATINATA / SATINED LENS	55	0,01	L055S.A/	01-02
LENTE ELLISSOIALE / ELIPSOID LENS	55	0,01	L055E.A/	01-02
LENTE ASIMMETRICA / ASYMMETRIC LENS	55	0,01	L055A.A/	01-02
FILTRO NIDO D'APE / HONEY COMB LOUVER	55	0,01	L055R.A/	01-02

VERSIONI DISPONIBILI / AVAILABLE VERSION

- KELVIN**
- 27 2700K
- 30 3000K
- 35 3500K
- 40 4000K

- FASCIO / BEAM**
- S** Spot
- F** Flood
- W** Wide

Per i gradi vedi in tabella.
For degree check the table.

48V DRIVERS VEDI | SEE P. 452

- DIMMABLE (OPTIONAL)**
- D** Dali Touch & Dimm

Per la versione Dali scegliere un alimentatore ON OFF da posizionare remoto.
For Dali version combine a ON OFF power supply to place remotely

- ## FINITURA / FINISHING**

- /01** bianco | white
- /02** nero | black
- /60** corten / corten

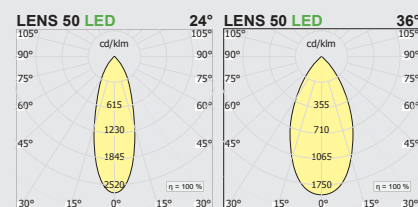

IPIPEDI 30/700H

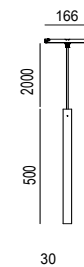

LED			lm product/beam 3000K		
W	Ø	H	S16°	F30°	CODE
8	30	700	695	720	PP002.9 ●●●/##

● Disponibili solo fascio **S, F** | Available only **S, F** beam

IPIPEDI 55/125H

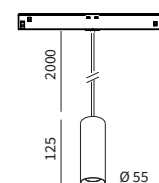

LED 48V			lm product/beam 3000K			
W	Ø	H	Kg	F24°	W36°	CODE
8	55	125 + 2000	1,30	860	860	PP005.9 ●●●/##
12	55	125 + 2000	1,30	1285	1285	PP119.9 ●●●/##
18	55	125 + 2000	1,30	1575	1575	PP120.9 ●●●/##

● Disponibili solo fascio **F, W** | Available only **F, W** beam

IPIPEDI 55/300H

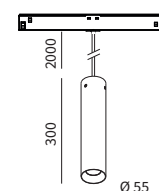

LED 48V			lm product/beam 3000K			
W	Ø	H	Kg	F24°	W36°	CODE
8	55	300	1,26	860	860	PP006.9 ●●●/##
12	55	300	1,26	1285	1289	PP116.9 ●●●/##
18	55	300	1,26	1575	1579	PP117.9 ●●●/##

● Disponibili solo fascio **F, W** | Available only **F, W** beam

iPipedi

Mini Track | Mini Track



Ø55 125h

versione con elemento per decentramento
version with ceiling fixing element



Ø55 300h

VARIANTE PER DECENTRAMENTO COMPLETO DI CAVO DI LUNGHEZZA DI 4000 mm PIÙ ELEMENTO DI FISSAGGIO A SOFFITTO
DECENTRALIZATION VERSION COMPLETE WITH CABLE LENGTH OF 4000 MM PLUS CEILING FIXING ELEMENT

IPIPEDI 55/125H
MINI TRACK 48V

LED 48V		lm product/beam 3000K				CODE
W	Ø	H	Kg	F24°	W36°	
8	55	125 + 4000	1,30	860	860	PP005L.9 ●●●/##
				F27°	W46°	
12	55	125 + 4000	1,30	1285	1285	PP116L.9 ●●●/##
18	55	125 + 4000	1,30	1575	1575	PP117L.9 ●●●/##



IPIPEDI 55/300H
MINI TRACK 48V

LED 48V		lm product/beam 3000K				CODE
W	Ø	H	Kg	F24°	W36°	
8	55	300 + 4000	1,30	860	860	PP006L.9 ●●●/##
				F27°	W46°	
12	55	300 + 4000	1,30	1285	1285	PP119L.9 ●●●/##
18	55	300 + 4000	1,30	1575	1575	PP120L.9 ●●●/##



Variante per decentramento completo di cavo di lunghezza di 4000 mm più elemento di fissaggio a soffitto
decentralization version complete with cable length of 4000 mm plus ceiling fixing element

ACCESSORI / ACCESSORIES



LENTI / LENSES Ø 55	Ø	Kg	CODE
LENTE SATINATA / SATINED LENS	55	0,01	L055S.A/ ##
LENTE ELLISSOIDALE / ELIPSOID LENS	55	0,01	L055E.A/ ##
LENTE ASIMMETRICA / ASYMMETRIC LENS	55	0,01	L055A.A/ ##
FILTRO NIDO D'APE / HONEY COMB LOUVER	55	0,01	L055R.A/ ##

VERSIONI DISPONIBILI / AVAILABLE VERSION

- **KELVIN**
- 27 2700K
- 30 3000K
- 35 3500K
- 40 4000K

- **FASCIO/BEAM**
- F** Flood
- W** Wide

- **DIMMABLE (OPTIONAL)**
- D** Dali Touch & Dimm

Per la versione Dali scegliere un alimentatore ON OFF da posizionare remoto (per alimentare il binario).
For Dali version combine a ON OFF power supply to place remotely (for feed the track)

48V DRIVERS VEDI | SEE 452

FINITURE STANDARD / STANDARD FINISHINGS

- / 01 bianco | white
- / 02 nero | black
- / 60 corten | corten

FINITURE PREMIUM / PREMIUM FINISHINGS

- / 81 oro rosa / rose gold
- / 82 bronzo anticato / antique bronze
- / 83 ottone brunito spazzolato / brushed burnished brass

iPipedi

Mini Track | Mini Track
Ø90



IPIPEDI 90/90H
MINI TRACK 48V

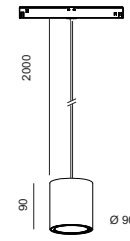

LED				lm product/beam 3000K		CODE
W	Ø	H	Kg	F24°	W38°	
12	90	90	1,0	1289	-	PP040.9 ●●●/##
17	90	90	1,4	1827	1905	PP041.9 ●●●/##
24,3	90	90	1,4	2356	2430	PP042.9 ●●●/##

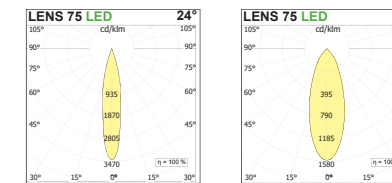

- **KELVIN**
- 27 2700K
- 30 3000K
- 35 3500K
- 40 4000K
- TW Tunable White Dali

- **FASCIO/BEAM**
- F Flood
- W Wide

- **DIMMABLE (OPTIONAL)**
- D Dali Touch & Dimm

Per la versione Dali scegliere un alimentatore ON OFF da posizionare remoto (per alimentare il binario).
For Dali version combine a ON OFF power supply to place remotely (for feed the track)

48V DRIVERS VEDI | SEE "ALIMENTATORI" A PAGINA 452

FINITURE STANDARD /STANDARD FINISHINGS
FINITURE PREMIUM /PREMIUM FINISHINGS

- /01 bianco/white
- /02 nero/black
- /60 corten

- FINITURE PREMIUM /PREMIUM FINISHINGS**
- /81 oro rosa/rose gold
- /82 bronzo antico/antique bronze
- /83 ottone brunito spazzolato/brushed burnished brass

MINITRACK

iPipedi

Mini Track | Mini Track
Ø55



I-PIPEDI 55C MINI TRACK



LED 48V			lm product/beam 3000K			
W	ø	H	Kg	F24°	W36°	CODE
8	55	110	1,30	860	860	PP007.9 ●●● /##
				F27°	W46°	
12	55	110	1,30	1285	1285	PP008.9 ●●● /##
18	55	110	1,30	1575	1575	PP009.9 ●●● /##

MINITRACK

● KELVIN

- 27 2700K
- 30 3000K
- 35 3500K
- 40 4000K
- TW Tunable White Dali

● FASCIO/BEAM

- F Flood
- W Wide

Per i gradi vedere in tabella -
For degree check the table

COMPOSIZIONE CODICE: xxx.x ●● /##

HOW TO CREATE THE CODE: F1000.827S /01

F1000.8 | ● | ● | /## finishing
base code | kelvin | beam

● DIMMABLE (OPTIONAL)

- D Dali Touch & Dimm

Per la versione Dali scegliere un alimentatore ON OFF da posizionare remoto (per alimentare il binario).
For Dali version combine a ON OFF power supply to place remotely (for feed the track)

/## FINITURA/FINISHING (PREMIUM AVAILABLE)

- /01 bianco/white
- /02 nero/black
- /60 corten

48V DRIVERS VEDI | SEE "ALIMENTATORI" A PAGINA 452

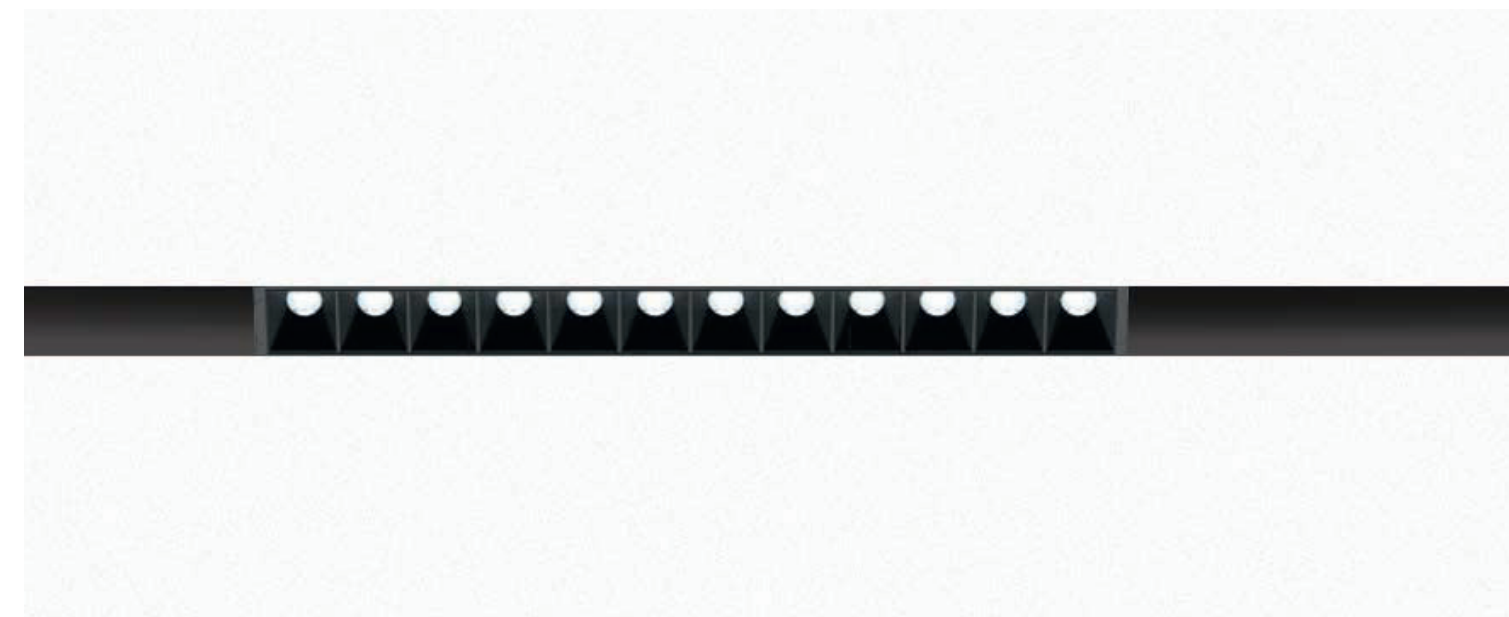

GRID

MINI TRACK

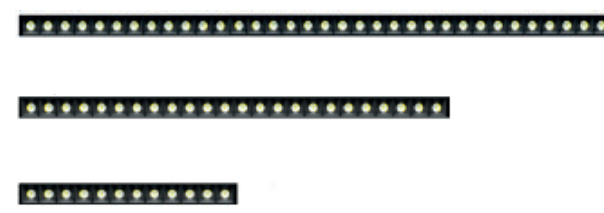

GRID MINI TRACK 48V

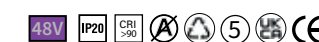

L	W	Lmm	DIM. mm	lm product 3000K		CODE
				24°	36°	
8	8	235	22 X 42 h	560	560	GRD01.9 ●●●/##
16	16	463	22 X 42 h	1100	1100	GRD02.9 ●●●/##
24	24	691	22 x 42 h	1650	1650	GRD03.9 ●●●/##

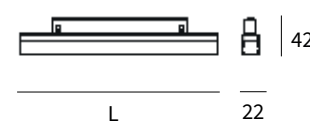

VERSIONI DISPONIBILI/AVAILABLE VERSION

- **KELVIN**
- 27 2700K
- 30 3000K

- **FASCIO/BEAM**
- F** Flood 24°
- W** Wide 36°

- **DIMMABLE (OPTIONAL)**
- D** Dali Touch & Dimm

Per la versione Dali scegliere un alimentatore ON OFF da posizionare remoto (per alimentare il binario).
For Dali version combine a ON OFF power supply to place remotely (for feed the track)

/## FINITURA/FINISHING

- /01 bianco | white
- /02 nero | black

COMPOSIZIONE CODICE: xxx.x ●●●/##
HOW TO CREATE THE CODE: **F1000.827S/01**

CODE
F1000.8 ● ● ● /## — finishing
base code kelvin beam dimmable

48V DRIVERS VEDI | SEE P.452

MINIGRID

ORIENTABILE | ADJUSTABLE

MINI TRACK



VERSIONI DISPONIBILI/AVAILABLE VERSION

- **KELVIN**
27 2700K
30 3000K
- **FASCIO/BEAM**
F Flood 24°
W Wide 36°
- **DIMMABLE (OPTIONAL)**
D Dali Touch & Dimm
- FINITURA/FINISHING**
/## /01 bianco | white
/02 nero | black

Per la versione Dali scegliere un alimentatore ON OFF da posizionare remoto (per alimentare il binario).
For Dali version combine a ON OFF power supply to place remotely (for feed the track)

COMPOSIZIONE CODICE: xxx.x ●●●/##
HOW TO CREATE THE CODE: **F1000.827SD/01**

CODE
F1000.8 ● ● ● /## — finishing
base code kelvin beam dimmable

48V DRIVERS VEDI | SEE P.452

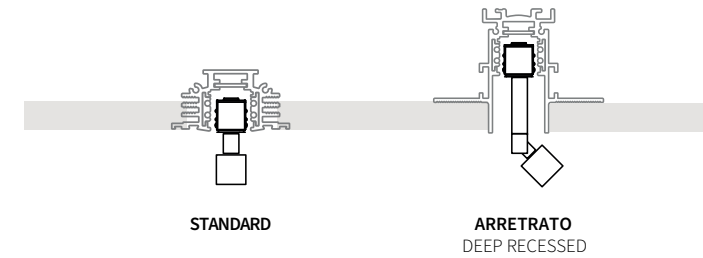

MINIGRID 235 MINI TRACK 48V

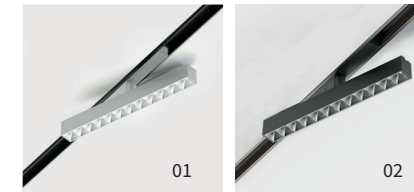

48V IP20 CRI >90 235 mm

LED 75lm/W

W	Lmm	Hmm	lm product 3000K	CODE
STANDARD			24° 36°	
8	235	22 + adattatore	560	560 GRD11.9 ●●●/##

Binario non incluso / mini track not included

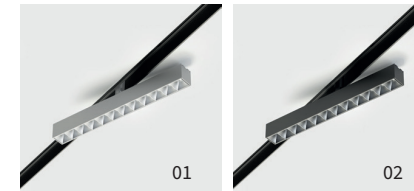

LED 75lm/W

W	Lmm	Hmm	lm product 3000K	CODE
ARRETRATO DEEP RECESSED TRACK				
8	235	47+ adattatore	560	560 GRD11A.9 ●●●/##

Binario non incluso / mini track not included

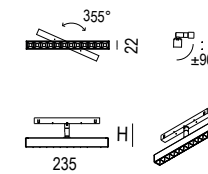

MINIGRID 461 MINI TRACK 48V

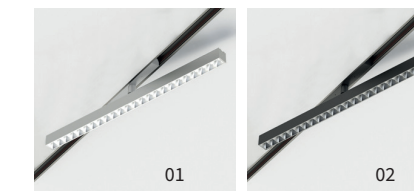

48V IP20 CRI >90 461 mm

LED 75lm/W

W	Lmm	Hmm	lm product 3000K	CODE
STANDARD			24° 36°	
16	461	22 + adattatore	1100	1100 GRD12.9 ●●●/##

Binario non incluso / mini track not included

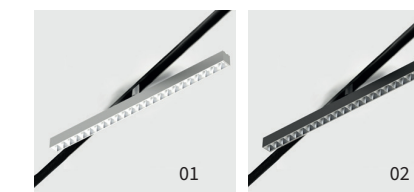

LED 75lm/W

W	Lmm	Hmm	lm product 3000K	CODE
ARRETRATO DEEP RECESSED TRACK				
16	461	47+ adattatore	1100	1100 GRD12A.9 ●●●/##

Binario non incluso / mini track not included

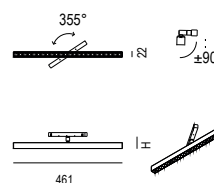

CUBOTTI

MINI TRACK

Collezione di apparecchi per un'illuminazione a binario 24V/48V. Apparecchi a luce diretta, disponibili in due versioni per sorgenti a tensione di rete LED con attacco GU10 o G9. Corpo a sezione quadrata in estruso di alluminio in finitura verniciata. Completati di staffa per fissaggio a soffitto o parete a seconda del modello. Grado di protezione IP20 e classe I.

Ceiling or wall mounted luminaires for direct or direct/indirect lighting, for LED mains voltage sources with GU10 or G9 socket. Square section body in extruded aluminum in painted finish. Complete with bracket for ceiling or wall mounting depending on the model. IP20 and class I.

KELVIN	
27	2700°K
30	3000°K
35	3500°K
40	4000°K
TW	Tunable White

FASCIO / BEAM	
S	SPOT
F	FLOOD
W	WIDE

FINITURE P / P FINISHINGS	
/01	BIANCO / WHITE
/02	NERA / BLACK

FINITURE FC / FC FINISHINGS	
/01	TELAIO BIANCO OTTICA NERA / WHITE FRAME BLACK OPTIC
/02	TELAIO NERO OTTICA NERA / BLACK FRAME BLACK OPTIC
/41	TELAIO BIANCO OTTICA BIANCA / WHITE FRAME WHITE OPTIC
/42	TELAIO NERO OTTICA ORO / BLACK FRAME GOLD OPTIC

FINITURE PREMIUM / PREMIUM FINISHINGS		
81-ORO ROSA / PINK GOLD	82-BRONZO ANTICATO / ANTIQUE BRONZE	83-OTTONE SATINATO / BRUSHED BRASS

CURVE FOTOMETRICHE/PHOTOMETRIC DATA

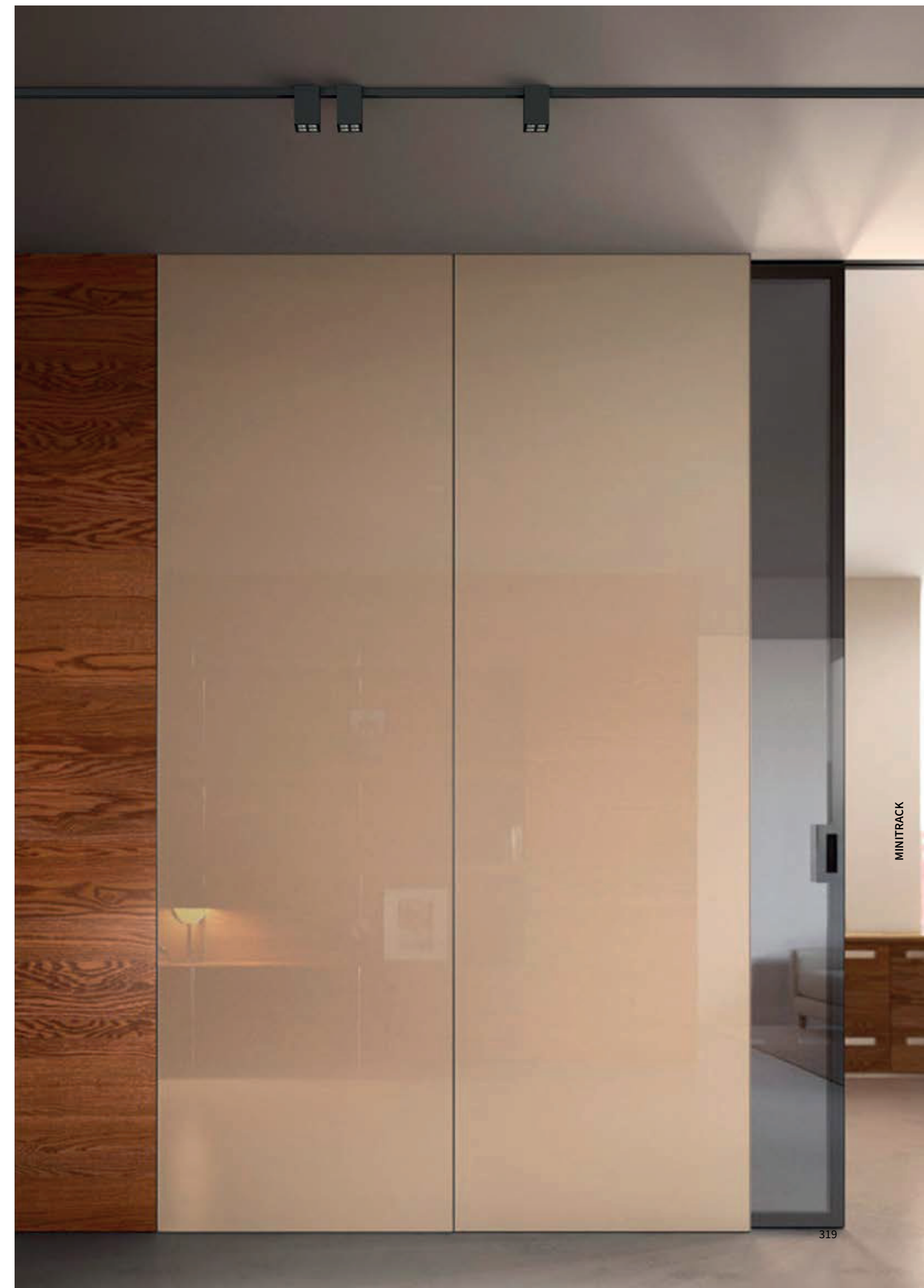
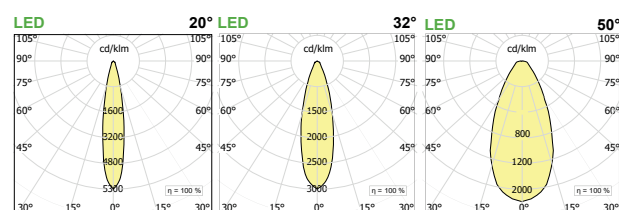

CUBOTTI

CUBOTTI F MINI TRACK INCASSO | RECESSED MINI TRACK

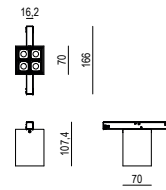
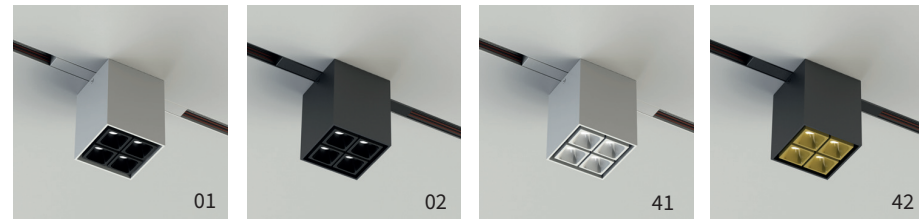

LED 24V e 48V		Im prod./beam 3000K					CODE
W	Dim.	H	Kg	S20°	F32°	W50°	CODE
8,8	70x70	90+adapter	0,80	800	745	662	CB001.9 ●●●/##

Binario non incluso / mini track not included

CUBOTTI PF MINI TRACK INCASSO | RECESSED MINI TRACK

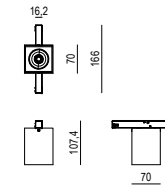
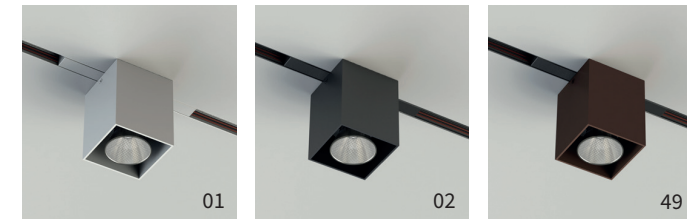

LED		Im prod./beam 3000K					CODE
W	mm	Hmm	Kg	F27°	W46°	CODE	
8	70x70	110	0,28	860	860	CB101.9 ●●●/##	
12	70x70	110	0,28	1285	1285	CB103.9 ●●●/##	

Binario non incluso / mini track not included

CUBOTTI C MINI TRACK SOFFITTO | CEILING MINI TRACK

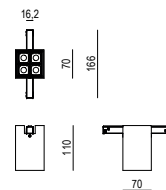
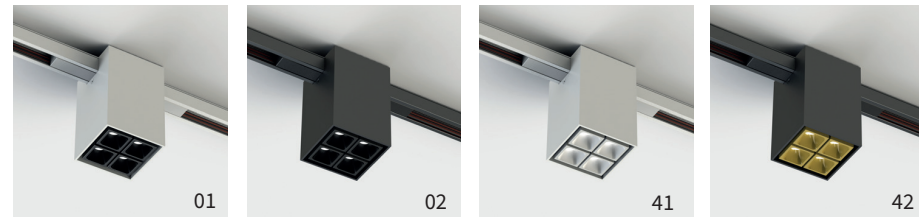

LED 24V e 48V		Im prod./beam 3000K					CODE
W	Dim.	H	Kg	S20°	F32°	W50°	CODE
8,8	70x70	110	0,80	800	745	662	CB002.9 ●●●/##

Binario non incluso / mini track not included

CUBOTTI PC MINI TRACK SOFFITTO | CEILING MINI TRACK

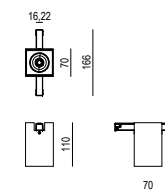

LED		Im prod./beam 3000K					CODE
W	mm	Hmm	Kg	F27°	W46°	CODE	
8	70x70	110	0,28	860	860	CB102.9 ●●●/##	
12	70x70	110	0,28	1285	1285	CB104.9 ●●●/##	

Binario non incluso / mini track not included

- **KELVIN**
 - 27 2700K
 - 30 3000K
 - 35 3500K
 - 40 4000K
 - TW Tunable White
- **FASCIO/BEAM**
 - S Spot 20°
 - F Flood 32°
 - W Wide 50°
- **DIMMABLE (OPTIONAL)**
 - D Dali Touch & Dimm

Per la versione Dali scegliere un alimentatore ON OFF da posizionare remoto (per alimentare il binario).
For Dali version combine a ON OFF power supply to place remotely (for feed the track)

- /## **FINITURA/FINISHING**
- /01 telaio bianco, ottica nera | white frame, black optic
- /02 telaio nero, ottica nera | black frame, black optic
- /41 telaio bianco, ottica bianca | white frame, white optic
- /42 telaio nero, ottica oro | black frame, gold optic

FINITURE PREMIUM DISPONIBILI / PREMIUM FINISHINGS ARE AVAILABLE

- **KELVIN**
- 27 2700K
- 30 3000K
- 35 3500K
- 40 4000K
- TW Tunable White Dali

- **FASCIO/BEAM**
- F Flood 27°
- W Wide 46°

- /## **FINITURA/FINISHING**

- /01 bianco/white
- /02 nero/black
- /49 bronzo / bronze

FINITURE PREMIUM / PREMIUM FINISHINGS

- /81 oro rosa/rose gold
- /82 bronzo anticato / antique bronze
- /83 ottone brunito spazzolato / brushed burnished brass

48V DRIVERS VEDI | SEE "ALIMENTATORI" A PAGINA 452



LUCE INDIRETTA SU PROFILO "E" /
INDIRECT LIGHT ON "E" PROFILE

DIFFUSORE INDIRETTO IN POLICARBONATO OPALINO / INDIRECT OPAL WHITE POLYCARBONATE DIFFUSER



L.mm	Kg	CODE
1000	0.16	LT94P.1000
2000	0.33	LT94P.2000
3000	0.50	LT94P.3000

MINITRACK

ELEMENTI LUMINOSI/ LIGHT ELEMENTS

LINEA DI LUCE

LINEA DI LUCE DA 5 METRI/ LED LINE 5 METERS ROLL



Strip led ad alta efficienza con biadesivo e supporto di larghezza 8-12 mm su bobina da 5 metri, da alimentare con driver stabilizzati in tensione da 24Vdc. Classe di isolamento III. | High efficiency strip led with biadhesive and support of 8-12 mm wide on 5 meters roll. To be fed with 24Vdc voltage-stabilized driver. Insulation class III.

Linea di luce Led IP20 24V     

W/m	V	Led/m	lm/m	lm/W	CRI	IP	Lmm	CODE	
4,8	24	120	620	129	90	20	5000	ST05.○.5	
9,6	24	160	1220	127	90	20	5000	ST10.○.5	
22	24	240	2700	123	90	20	5000	ST22.○.5	
16,8	24	COB	1400	2700-6500K	84	90	20	5000	ST22.TW.5

W/m	V	Led/m	lm/m	lm/W	CRI	IP	Lmm	CODE
9,6	24	160	1073	111	90	67	5000	ST10.○.5IP
16,8	24	200	1822	108	90	67	5000	ST18.○.5IP

W/m	V	Led/m	lm/m	type	cut	IP	Lmm	CODE
19,2	24	COB	640	RGBW 2700K	33,3	20	5000	ST19.2.RGBW.5
19,2	24	COB	655	RGBW 3000K	33,3	20	5000	ST20.RGBW.5
19,2	24	COB	540	RGBW 2700K	33,3	67	5000	ST19.RGBW.5IP
25+22,5	24	270	4100	RGB + White 3500K	55,4	20	5000	ST19.RGBW.5

CUTS

IP20

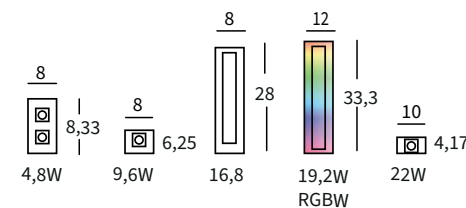

IP67

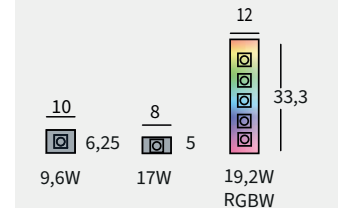

VERSIONI DISPONIBILI/AVAILABLE VERSION

- KELVIN
- 27 2700K
- 30 3000K
- 35 3500K
- 40 4000K

COMPOSIZIONE CODICE: xxx.x ○ /##

HOW TO CREATE THE CODE: F1000.827/01

CODE
F1000.8 ○ /## — finishing
| |
base code kelvin



DRIVERS VEDI | SEE P.452 