

2

SCENARI

LE COLLEZIONI

DOWNLIGHT
WALL, CEILING, SUSPENSION, FLOOR
PROJECTORS
MINI TRACK COLLECTION
OUTDOOR

lucifero's
ARCHI-TECH LIGHTING

Shape your light



lucifero's
ARCHI-TECH LIGHTING

dal 1978

**Progettiamo dettagli.
We design details.**

Dal 1978 diamo spazio alla luce. Realizziamo idee illuminate, coniugando creatività, innovazione e curiosità. Progettiamo nuove soluzioni, attraverso lo studio e la ricerca, per creare sempre una luce migliore.

We've been putting light first since 1978, generating bright ideas by merging creativity, innovation and curiosity. Meticulous investigation and research allow us to design new solutions that create ever-better light.

La nostra forza non si specifica solo attraverso i nostri prodotti ma vede la sua massima espressione in un approccio trasversale. Alla complessità delle necessità dei nostri clienti, rispondiamo con un dialogo continuo e con la condivisione di risposte tailor made. Con una grande forza distributiva. Con un valore unico che racchiude la nostra filosofia: il Made in Italy. E ultimo, ma non certo meno importante, il nostro più grande vanto, un team di progettisti in grado di descrivere la luce attraverso ombre, contrasti e contrappunti ritmici per guidarvi con attenzione, intuizione e capacità tecnologica nel mondo del lighting design.

Our strength extends beyond our products, finding its ultimate expression in an all-encompassing design approach. The complexity of our customers' needs are met through continuous dialogue and the sharing of tailor-made solutions. With a far-reaching product distribution network... and a unique value that exemplifies our philosophy: Made in Italy. And then, the jewel in the crown: a team of designers who 'draw' light with shadows, contrasts and rhythmic counterpoints to take you - intuitively and technologically - into the world of lighting design.

Il nostro obiettivo è integrare con armonia il corpo illuminante con l'architettura, in continuità con le funzioni dello spazio che lo accoglie. Per questo motivo definiamo Lucifero's con l'accezione di Archi-Tech Lighting. Un'espressione che accoglie l'alto standing di progettualità, in grado di esaudire le necessità di qualsivoglia applicazione. Che sia retail, hospitality, museale, educational o green.

Our goal is to merge lighting fixtures and architecture seamlessly, perfectly complementing the areas they're installed in. That's why we define Lucifero's products as Archi-Tech Lighting. An expression that encapsulates a design skillset capable of meeting the needs of any project: retail, hospitality, museums, educational or 'green'.



**Fatto in Italia,
distribuito
nel mondo.
Made in Italy,
distributed
worldwide.**

Essere italiani è un sentimento di cui andiamo orgogliosi. Proporre e veicolare un valore fondamentale come il Made in Italy è, quindi, parte essenziale di ogni nostra azione. Ed è proprio da Bologna che la nostra visione si apre a tutto il mondo. Un respiro che si fa internazionale, rimanendo sempre ben conscio della propria identità.

We're proud to be Italian. Conveying a value as essential as 'Made in Italy' is, then, a crucial part of everything we do. And Bologna is the launch pad from which we extend our vision to the world: an international vision that retains full awareness of its roots.



Green indoor lighting

In campo indoor, non è sempre possibile donare al proprio habitat green un'illuminazione funzionale. Le motivazioni sono molteplici. Ogni pianta ha esigenze particolari, di intensità come di spettri luminosi specifici.

Partendo da questi assunti, la nostra progettualità si è spinta in un nuovo campo di specializzazione dedicato alla luce artificiale naturale.

Lucifero's propone, infatti, sistemi di illuminazione cablati con LED HC (Horticulture) a spettro dedicato alle piante ornamentali. Sistemi lineari con piastre LED ed ottiche per illuminazione in radenza e wallwasher per pareti verdi o proiettori equipaggiati con COBHC per illuminazione di accento di piante singole o aree verdi indoor.

In indoor settings, it's not always possible to ensure adequate 'green habitat' lighting. The reasons are manifold. Every plant has specific lighting needs in terms of both intensity and spectra.

On that basis, we've targeted our design efforts at a whole new field of specialization, that of 'natural' artificial light.

Lucifero's provides, in fact, lighting systems with HC (Horticulture) LEDs that emit a spectrum tailored to ornamental plants. These include linear systems with LEDs and optics for oblique lighting and wallwashers for green walls, or spotlights with COBHC for the accent lighting of individual plants or indoor green areas.



Design support

Lucifero's dispone di un team di progettisti illuminotecnici in grado di supportare nelle scelte progettuali in materia di apparecchi di illuminazione. Inviandoci le piante dei vostri progetti avremo modo di consigliare sul tipo di illuminazione più appropriata alle vostre esigenze e sulla quantità e tipologia di apparecchi necessari alla corretta realizzazione del progetto, corredando le proposte con calcoli fotometrici professionali.

Lucifero's has a team of lighting designers who can support on the design choices. Send us your project: we will be able to advise on the most appropriate lighting fixtures to use accompanying the proposals with professional photometric calculations.

Configuratore di sistemi con metodo Drag & Drop /System configurator with Drag & Drop method.

Disponibile sul nostro sito *Requisiti minimi richiesti schermo da 10 pollici* . Available on our website. *Minimum requirements required 10 inches screen*

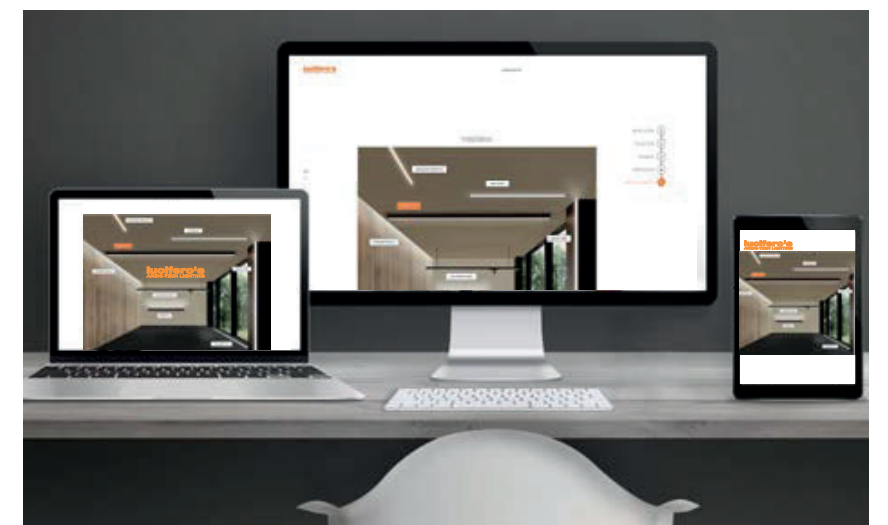



Lucifero's va oltre l'illuminazione: creiamo esperienze luminose uniche integrate perfettamente con l'architettura, diventando parte essenziale di ogni spazio.

Questo volume vi invita a esplorare il connubio tra illuminazione e design, dove ogni prodotto racconta storie di eleganza e unicità. Un viaggio emozionale attraverso spazi luminosi che ispirano.

Scoprite con noi la magia, dove ogni luce è una storia, ogni ambiente una tela.

Lucifer's goes beyond lighting: we create unique lighting experiences that are perfectly integrated with architecture, becoming an essential part of any space.

This volume invites you to explore the union between lighting and design, where each product tells stories of elegance and uniqueness. An emotional journey through bright spaces that inspire.

Discover with us the magic, where every light is a story, every environment a canvas.

FINITURE FINISHINGS

/01



BIANCO
WHITE

/02



NERO
BLACK

/03

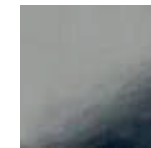

CROMO
CHROME

/27



ALLUMINIO ANODIZZATO
ANODIZED ALUMINIUM

/36

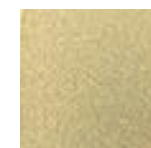

ORO
GOLD

/44C



ORO CHAMPAGNE
CHAMPAGNE GOLD

/49



BRONZO
BRONZE

/60



CORTEN

/81



ORO ROSA
ROSE GOLD

/82



BRONZO ANTICATO
ANTIQUÉ BRONZE

/83



OTTONE BRUNITO SPAZZOLATO
BRUSHED BURNISHED BRASS

/99



GRAFITE
GRAPHITE



Lucifero's offre una garanzia di 5 anni sulla sua gamma di prodotti contro i difetti di fabbricazione. Tutti gli alimentatori e gli accessori utilizzati per l'installazione devono essere parti originali Lucifero's o approvate dalla società. La garanzia decade se vengono utilizzate parti non originali o non approvate. Nel caso di apparecchi dotati di sorgenti led la garanzia copre anche i led.

Lucifero's offers a 5-Year warranty on its product against manufacturing defects. All power supplies and accessories used for the installation shall be original Lucifero's parts or approved by the company. The warranty will be void if non original or not approved parts are used.

Within fixtures equipped with led sources the guarantee covers also the leds.

5
years
guaranteed

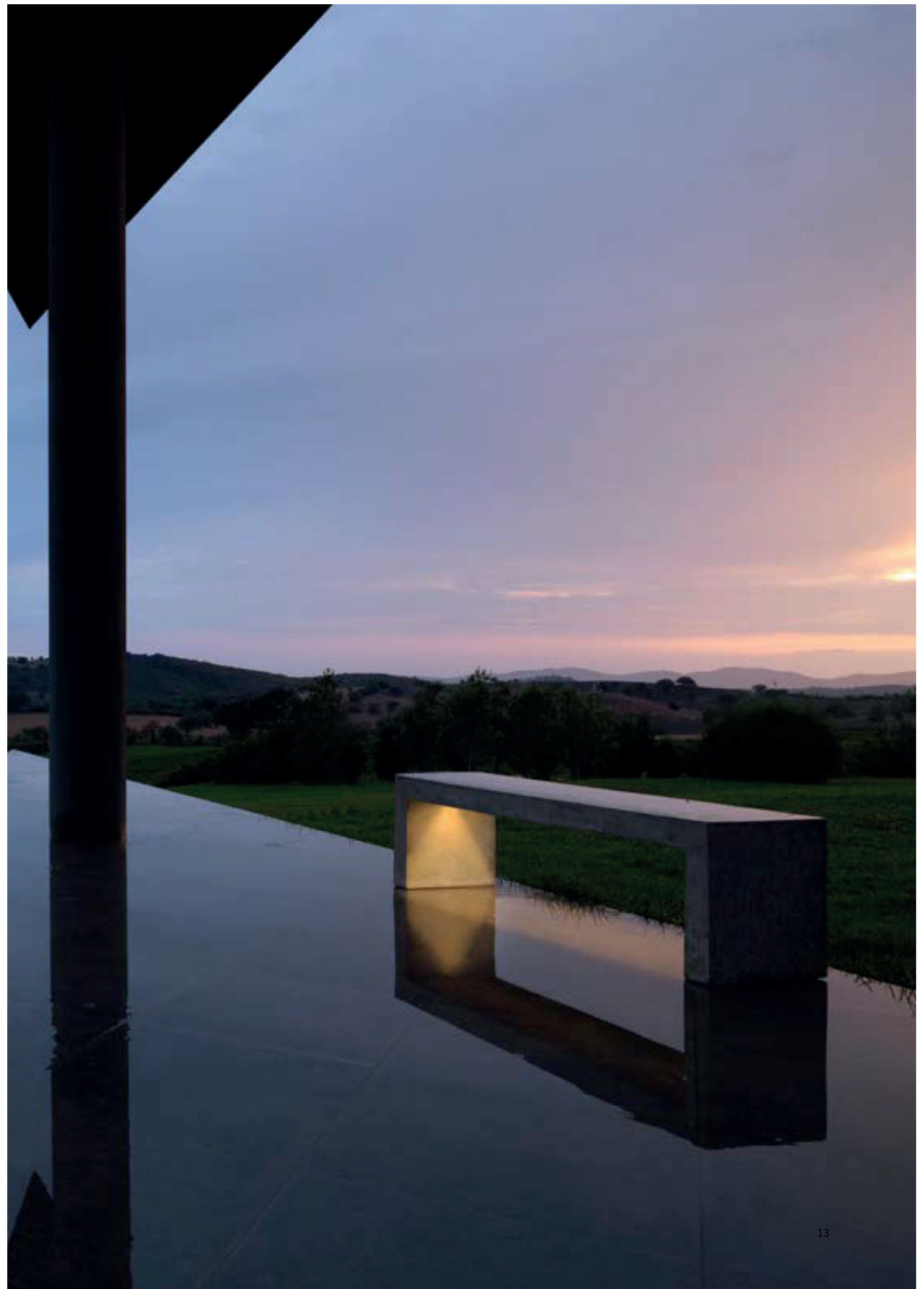

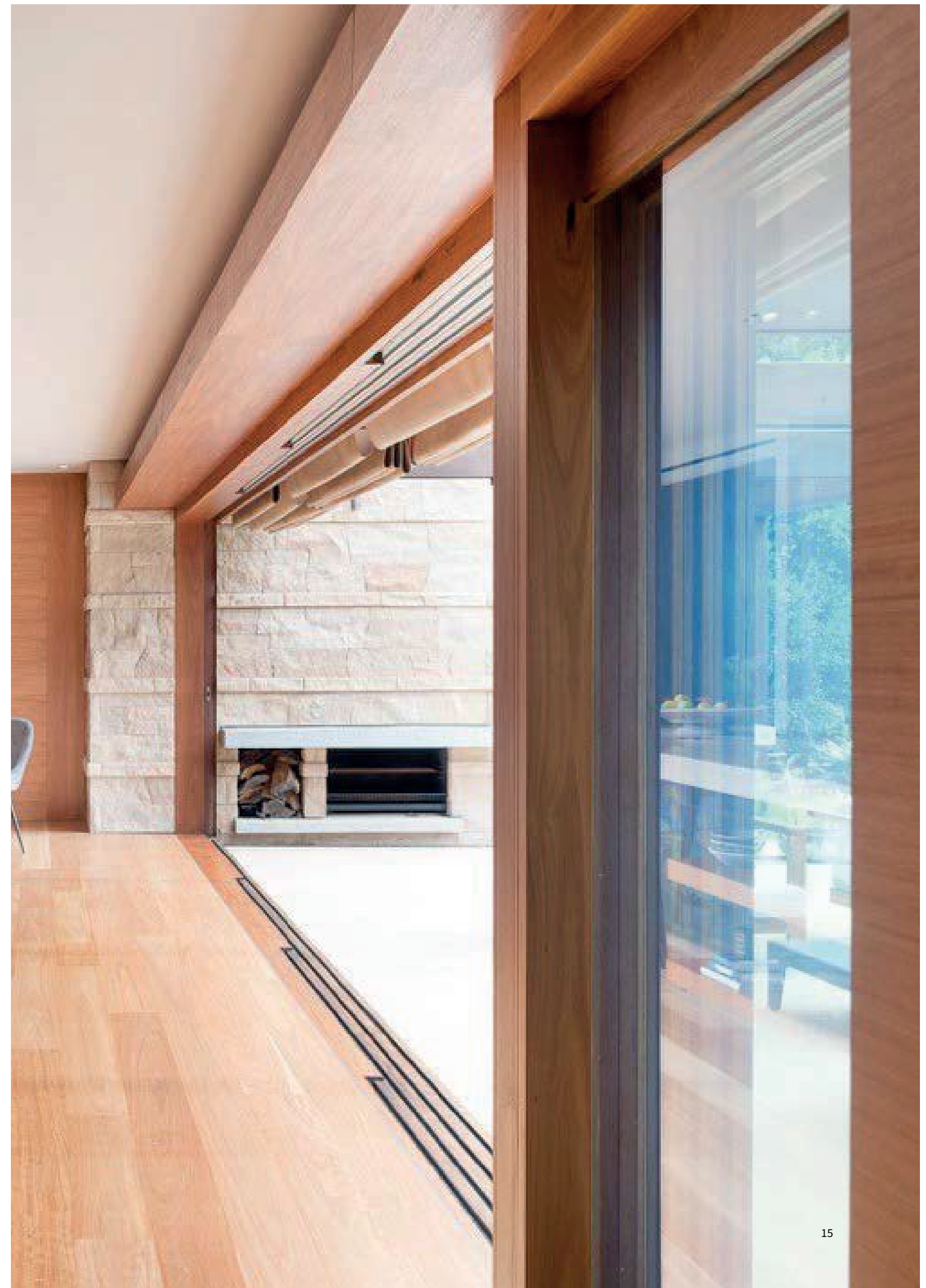

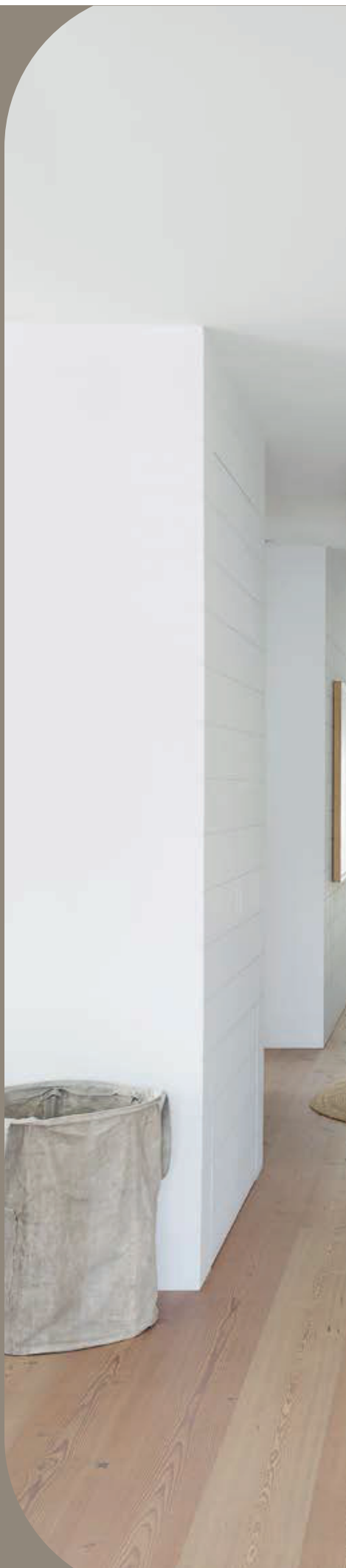

SCENARI

36

DOWNLIGHT

164

PROJECTORS

208

WALL, CEILING & SUSPENSION, FLOOR

284

MINI TRACK

324

OUTDOOR

450

APPENDIX



INDOOR - Incassi | Downlight

IRIDE INCASSO P. 41 NEW



BEST P.47 NEW

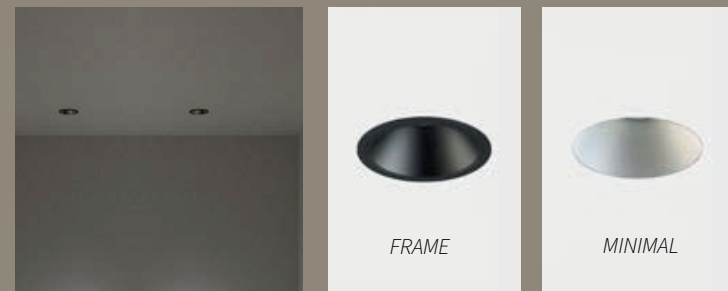

I-KONE P.56 NEW



I-SQUARE P.58 NEW

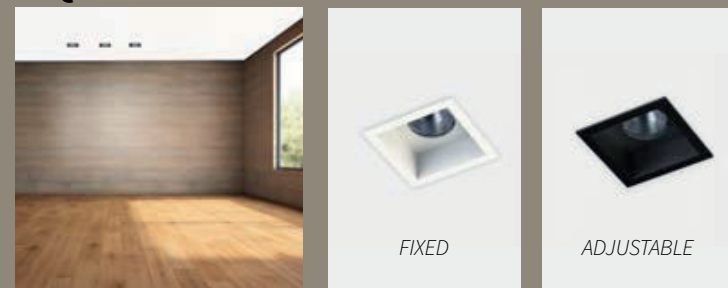

CONVEX P.60 NEW

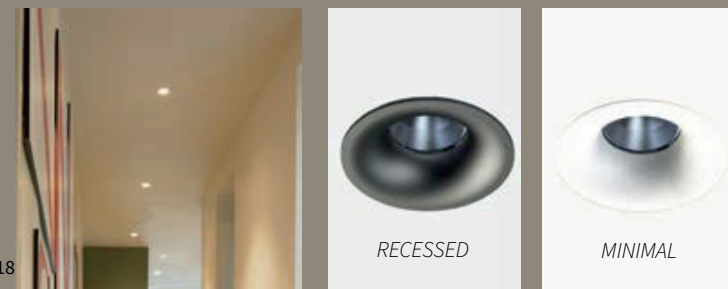

INDOOR - Incassi | Downlight

STICK P.62 NEW



SPOTTINO P.65 NEW

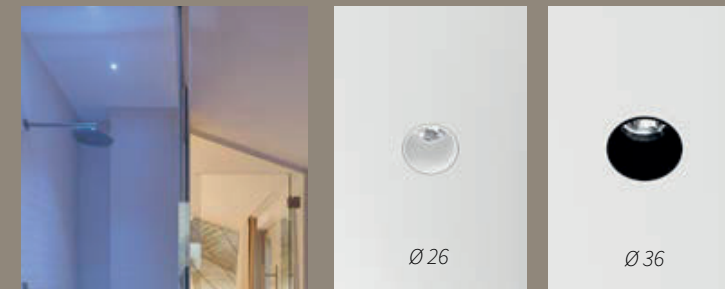

CI P.69

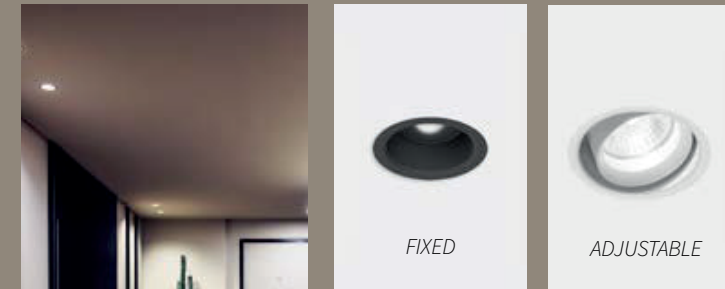

NYX P.75 NEW

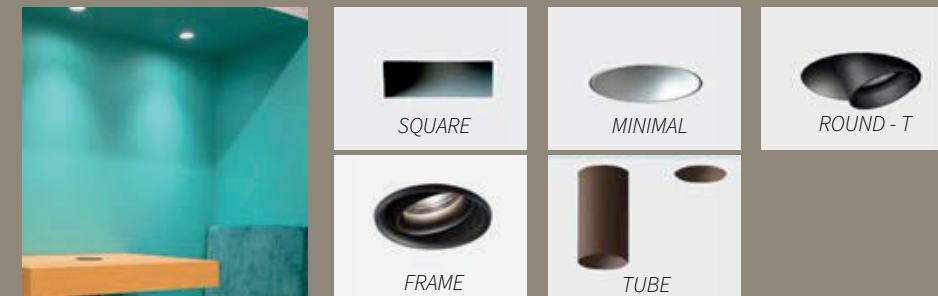

TWENTY 7 P.95



INDOOR - Incassi | Downlight

LEVA & LEVA QUADRA P.105

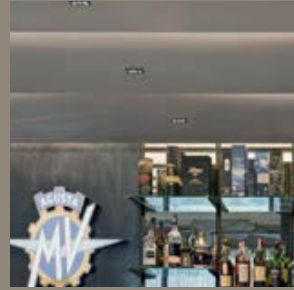

MINI SIGHT & SIGHT P.121



MINI INCAS P.137



INCAS P.143

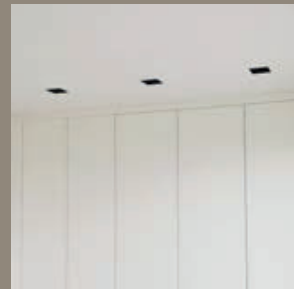

INDOOR - Incassi | Downlight

INCAS 45/90 P.149

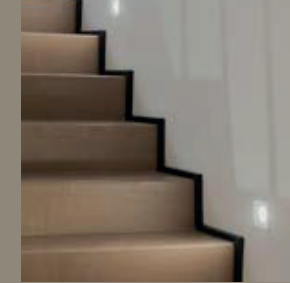

INCAS 45



INCAS 90

MINIFRAME P.153

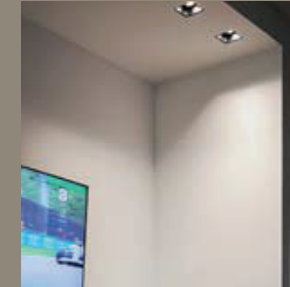

35 X 35



50 X 50

STEP P.157

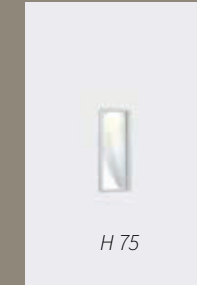

H 75



H 150



H 300

WINDOW P.161

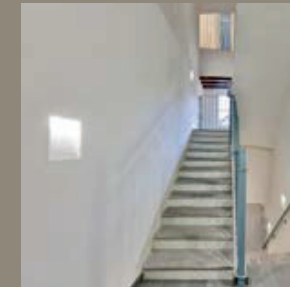

WINDOW 224



WINDOW 306

INDOOR - Proiettori | Projectors

CORONA P.168 *NEW*



IRIDE P.175

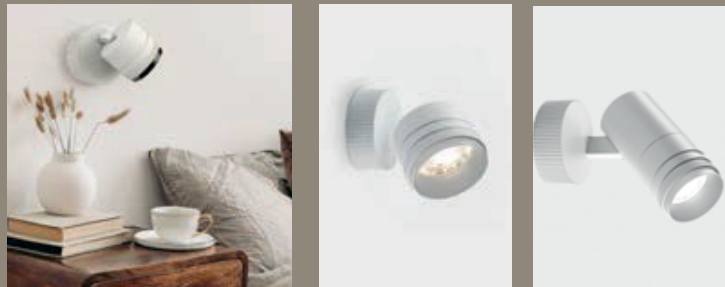

LEVA QUADRA P.181



FOCUS P.187 *NEW*



SEMPLICE P.199



PHAR P.205

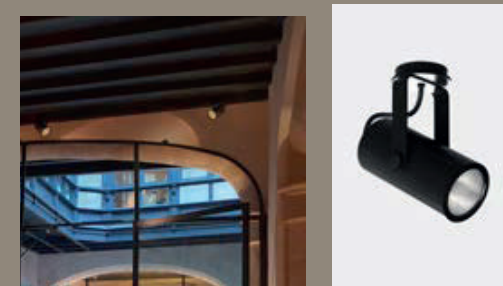

PROIETTORI PER TRACK SYSTEM 230V - TRACK SYSTEM 230V PROJECTORS
 vedi/see VOL. 1 - PROFILI - Le Collezioni "Track System"

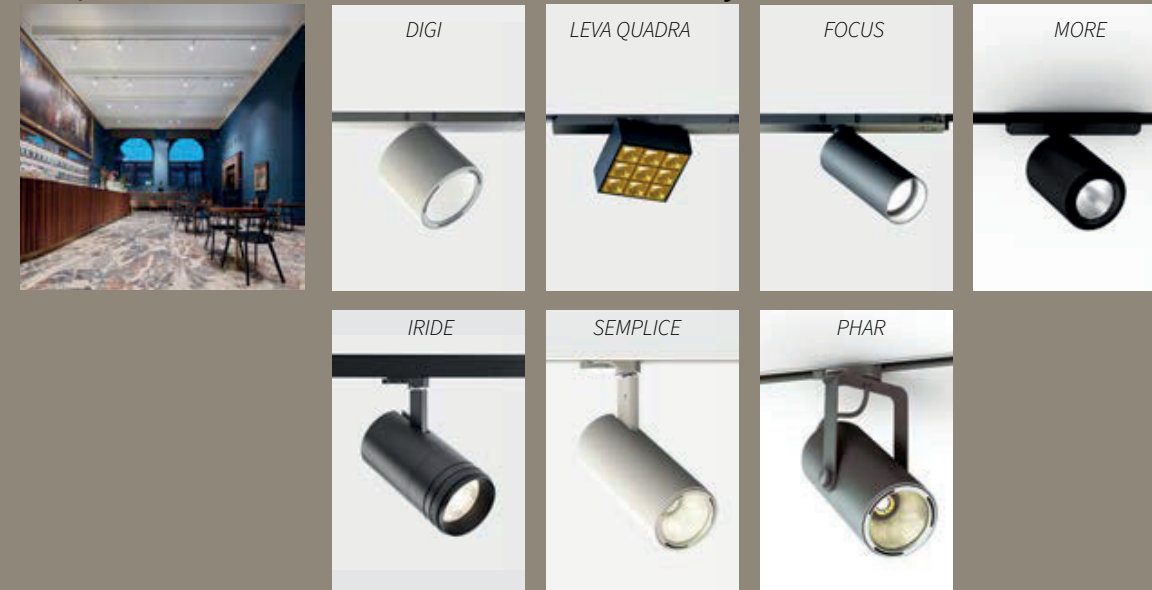

INDOOR - Parete, Soffitto, Sospensione e Terra | Wall, Ceiling , Suspension & Floor

MINIFILE MIX P.212 NEW



ICEMENTI P.217

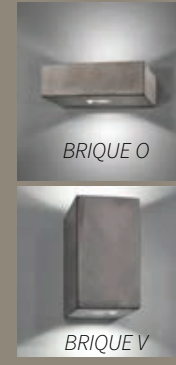
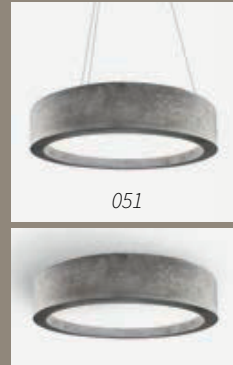

IPIEDIQ P.225



IPIEDI P.231 NEW

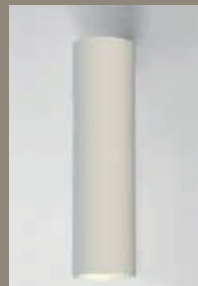

INDOOR - Parete, Soffitto, Sospensione e Terra | Wall, Ceiling , Suspension & Floor

IBRIDA P.243 NEW

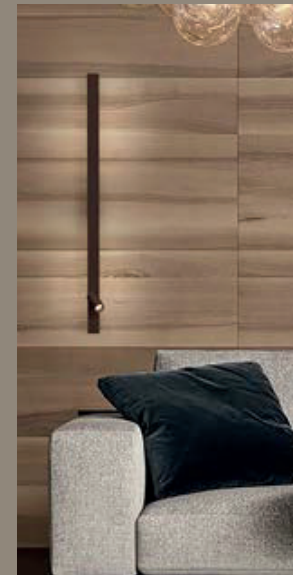

AURA IN P.259 NEW

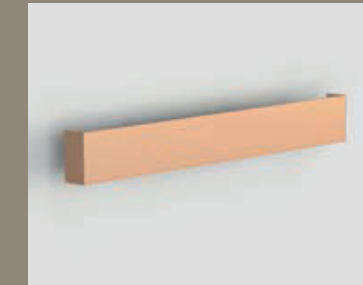
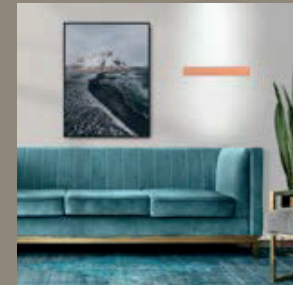

LEVA P.263

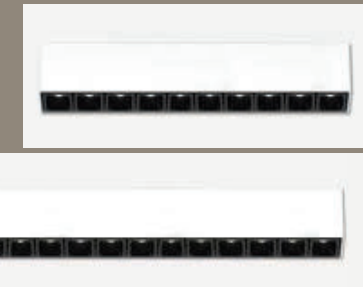
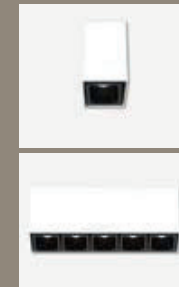

FILE 2 COMPLEMENTI P.269

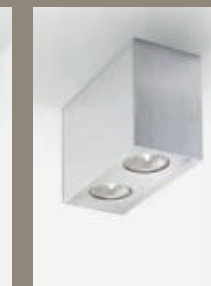

INDOOR - Parete, Soffitto, Sospensione e Terra | Wall, Ceiling, Suspension & Floor

MANINE P.273 **NEW**



APP P.282



INDOOR - Mini Track system & projectors



MICROFILE P.298



LEVA P.300 **NEW**



LEVA QUADRA P.302

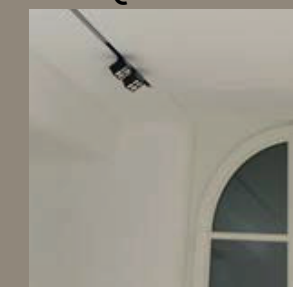

IRIDE P.303

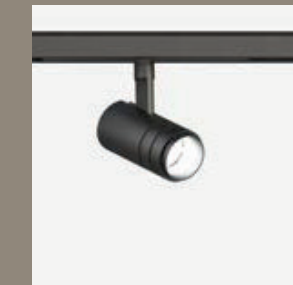

FOCUS P.304

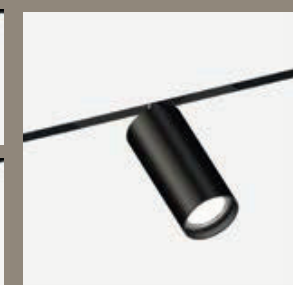

INDOOR - Mini Track system & projectors

IPIPEDI P.307 **NEW**



GRID P.315 **NEW**

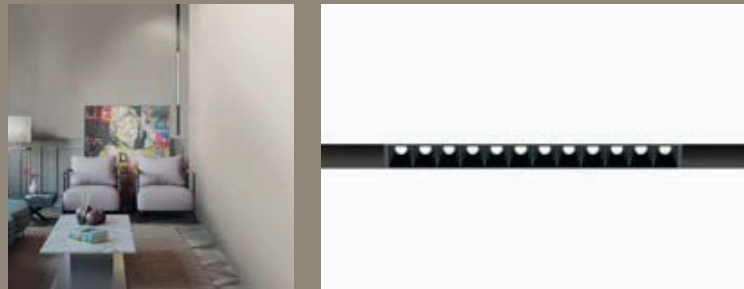

MINIGRID P.316 **NEW**

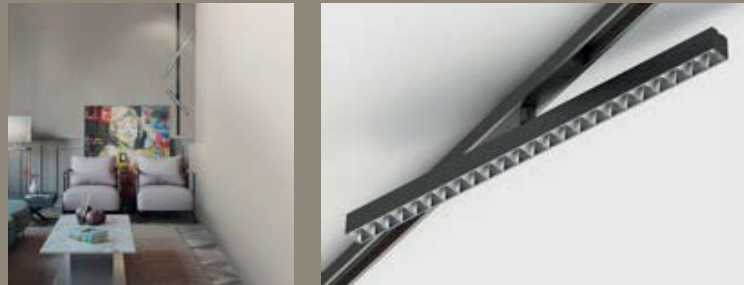

CUBOTTI P.318

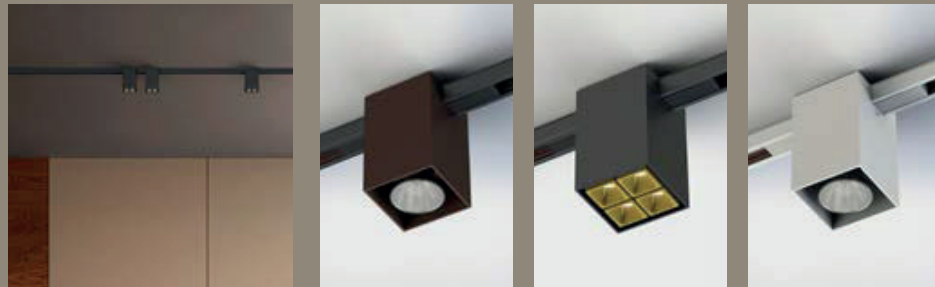

OUTDOOR

SKYLINE P.340 **NEW**

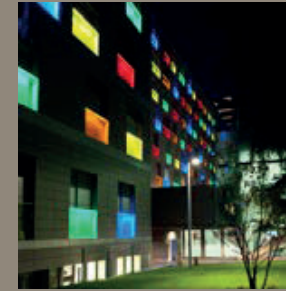

Incassi | Downlighter

NOTTE SYSTEM P.328 **NEW**

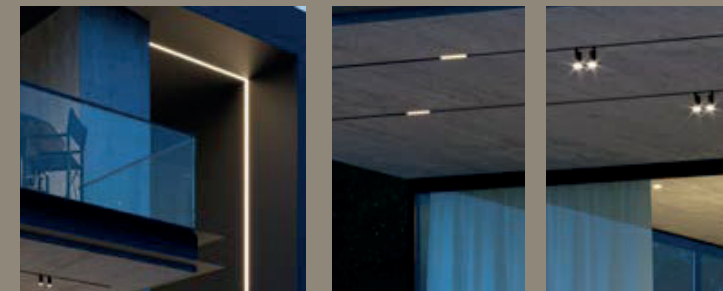

IGROUND P.379

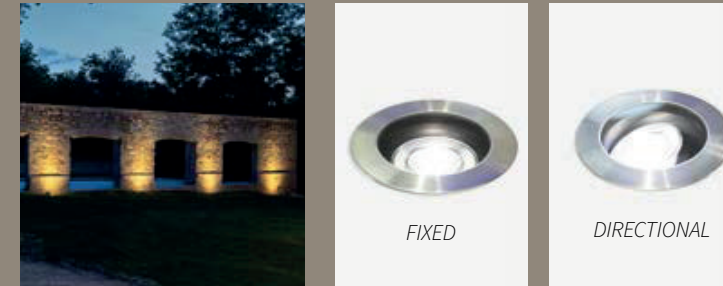

NYX P.385

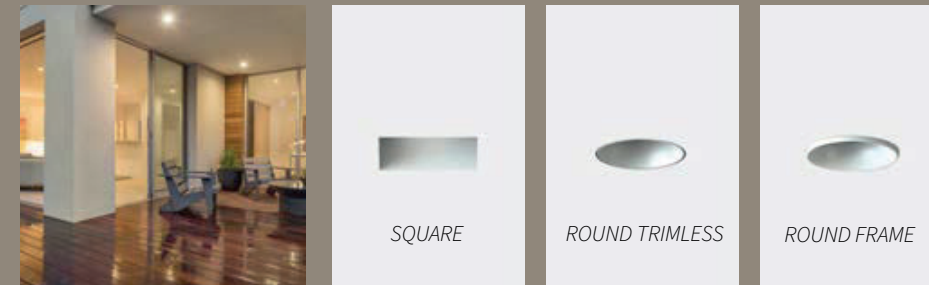

STEP P.395



LEVA P.439



OUTDOOR

Terra | Floor

FILE FLEX P.351

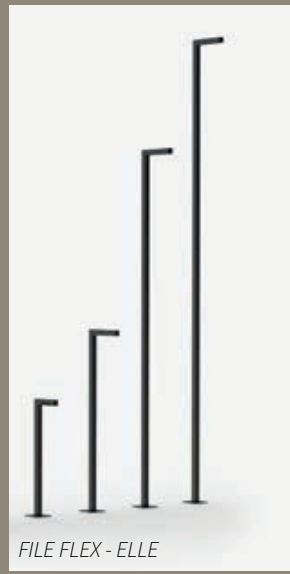
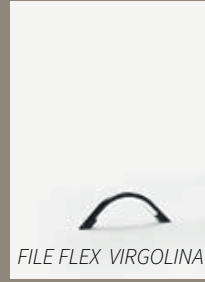

IFERROSI P.361

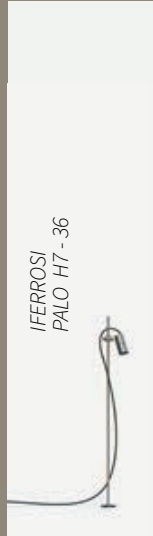
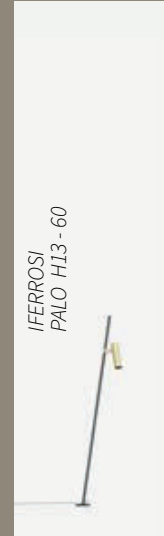
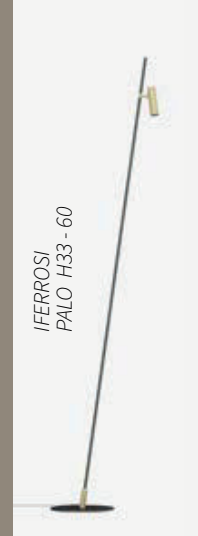
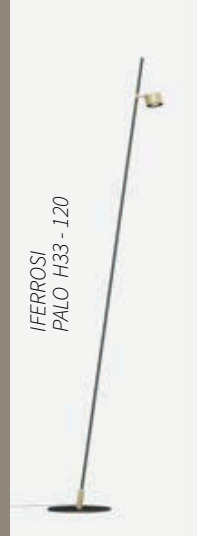

ICEMENTI COLLECTION P.405



OUTDOOR

NANOFIL P.399



Parete | Wall

IFERROSI PP.361



IRIDE P.411



MANINE P.417



ICEMENTI COLLECTION P.405

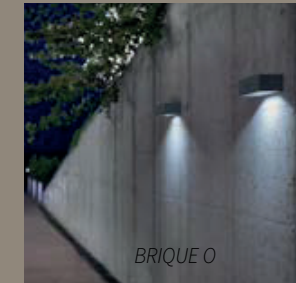

AURA OUT P.425 **NEW**

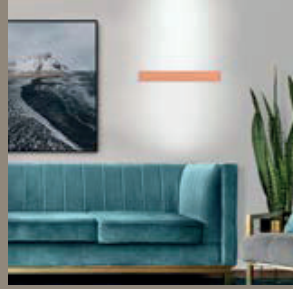

OUTDOOR

IPIPEDI P.429



LEVA P.444

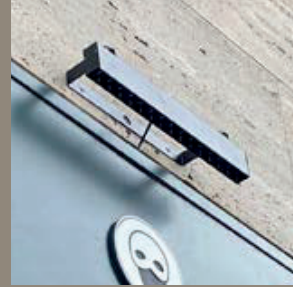

FILE 2 P.448



Parete-Terra | Wall-Floor

IFERROSI P.361 **NEW**



BUCOLICA P.343 **NEW**



ARBOREA P.348 **NEW**



PHAR P.348.422 **NEW**



Sospensione | Suspension

IFERROSI P.361 **NEW**

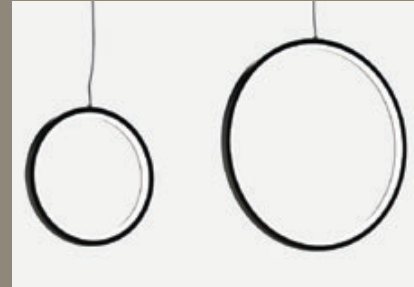
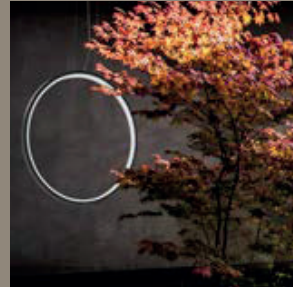

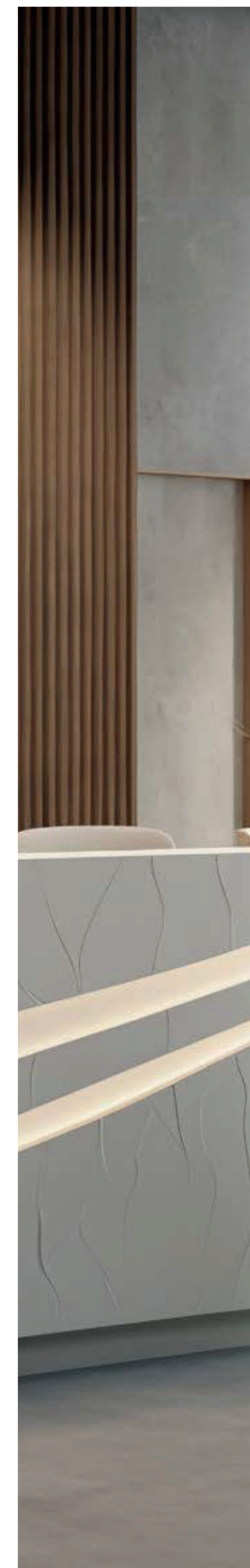

- 36** | **DOWNLIGHT**
 Best p. 47
 Ci p. 69
 Convex p. 60
 i-Kone p. 54
 Incas p. 143
 Incas 45/90 p. 149
 Iride incasso p. 41
 i-Square p. 58
 Leva p. 105
 Leva quadra p. 115
 Mini Incas p. 137
 Miniframe p. 153
 Minisight p. 121
 Nyx p. 75
 Sight p. 131
 Spottino p. 65
 Step p. 157
 Stick p. 62
 Twenty7 p. 95
 Window p. 161

- 164** | **PROJECTORS**
 Corona p. 167
 Focus p. 187
 Iride p. 175
 Leva quadra p. 181
 Phar p. 205
 Semplice p. 199

- 208** | **WALL, CEILING & SUSPENSION, FLOOR**
 App p. 281
 Aura in p. 259
 File2 complementi p. 269
 Ibrida p. 243
 iCementi p. 217
 iPipedi p. 231
 iPipediQ p. 225
 Leva p. 263
 Manine p. 273
 Minifile Mix p. 212

- 284** | **MINI TRACK**
 Cubotti p.318
 Focus p. 304
 Grid p. 315
 Ipipedi p. 306
 Iride p. 303
 Leva p. 300
 Leva quadra p. 302
 Microfile p. 298
 Minigrad p. 316

- 324** | **OUTDOOR**
 Arborea p. 348
 Aura out p. 425
 Bucolica p. 343
 File 2 p. 448
 File Flex p. 351
 iCementi p. 405
 iFerosi p. 361
 iGround p. 379
 iPipedi p. 429
 Iride p. 411
 Leva p. 439
 Leva graffa p.446
 Leva quadra p. 444
 Phar Outdoor p.422
 Manine p. 417
 Nanofile p. 399
 Notte system p. 328
 Nyx p. 385
 Skyline p. 339
 Step p. 395

- 450** | **APPENDIX**

INDOOR - Incassi | Downlight

IRIDE INCASSO P. 41 **NEW**



BEST P.47 **NEW**

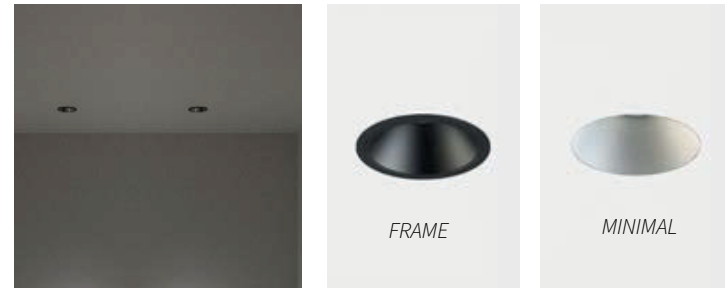

IKONE P.56 **NEW**



ISQUARE P.58 **NEW**

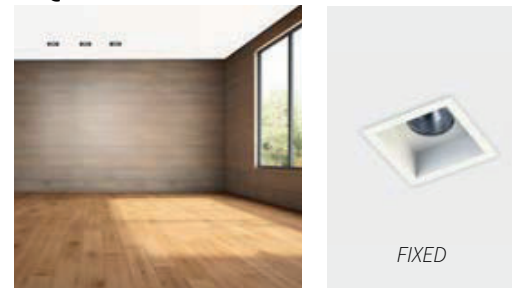

CONVEX P.60 **NEW**

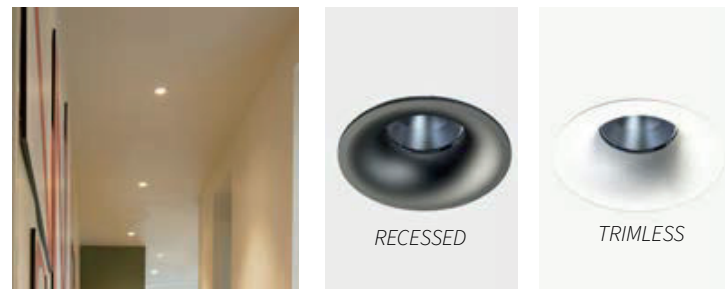

STICK P.62 **NEW**



SPOTTINO P.65 **NEW**

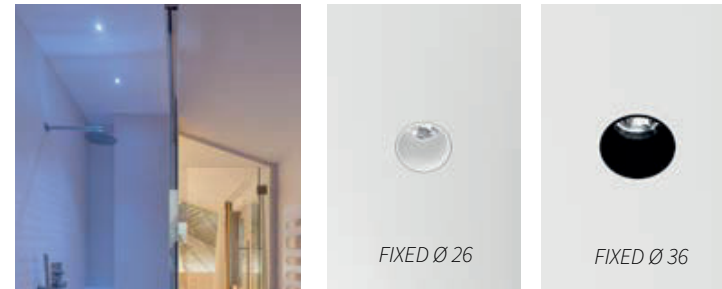

CI P.69

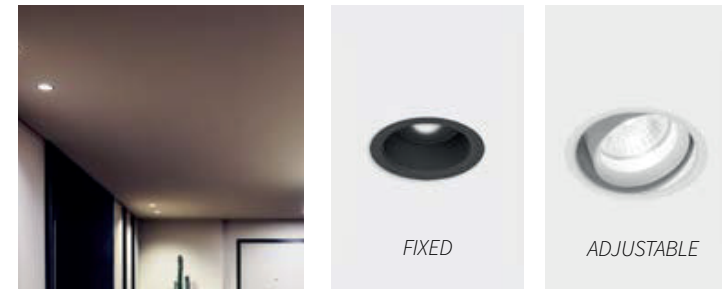

NYX P.75

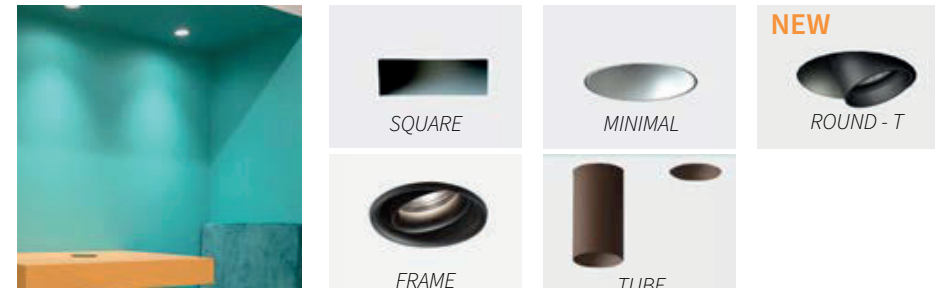

TWENTY 7 P.95



INDOOR - Incassi | Downlight

LEVA & LEVA QUADRA P.105

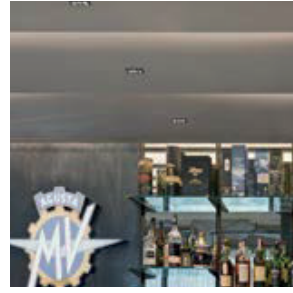

INCAS 45/90 P.149

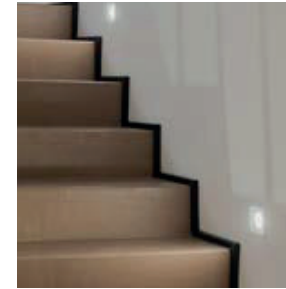

INCAS 45

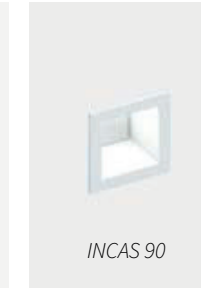

INCAS 90

MINI SIGHT P.121

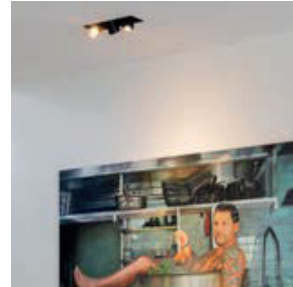

MINIFRAME P.153

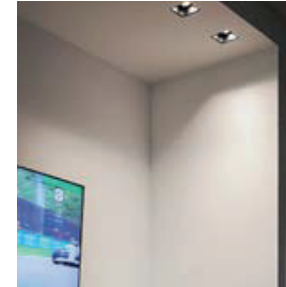

35 X 35



50 X 50

SIGHT P.131



STEP P.157

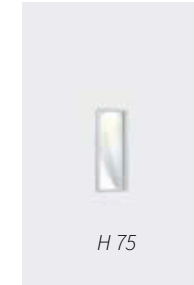
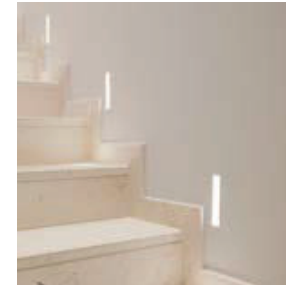

H 75



H 150



H 300

MINI INCAS P.137

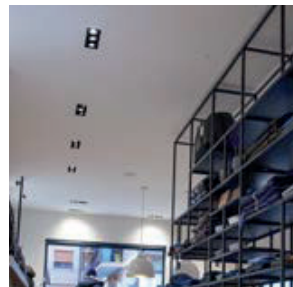

WINDOW P.161

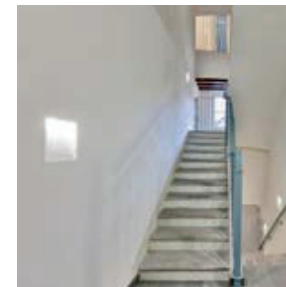

WINDOW 224



WINDOW 306

INCAS P.143









IRIDE INCASSO

IRIDE

INCASSO | RECESSED



FINITURE STANDARD / STANDARD FINISHINGS

	01 BIANCO - ANELLO BIANCO WHITE - WHITE RING		21 BIANCO - ANELLO CROMO WHITE - CHROME RING		28 BIANCO - ANELLO NERO WHITE - BLACK RING
	02 NERO - ANELLO NERO BLACK - BLACK RING		25 NERO - ANELLO CROMO BLACK - CHROME RING		

La collezione firmata Mario Cucinella si arricchisce della versione ad incasso. Iride è costituita da un corpo in pressofusione di alluminio verniciato e da un anello intercambiabile cromo, bianco o nero. Gruppi ottici completi di led ad alta resa cromatica (CRI>90), lente, housing antiabbagliamento e driver elettronico. Corpo ottico fisso o orientabile con possibilità di orientamento 0-90° rispetto all'asse orizzontale. Ottiche spot, flood e wide. Grado di protezione IP20.

The collection by Mario Cucinella has a new version: recessed. Iride consists of a body in painted die-cast aluminum and an interchangeable ring – in white, black or chrome finishing. Optical groups complete with high color rendering LEDs (CRI>90), lens, anti-glare housing and electronic driver. Fixed or adjustable optical body, with the 0-90° orientation on the horizontal axis. Spot, flood and wide optics. IP20.



MARCHIO DI PRODOTTO DEL REGNO UNITO CHE DEVE ESSERE UTILIZZATO PER I PRODOTTI IMMESSI SUL MERCATO IN GRAN BRETAGNA (INGHILTERRA, GALLES E SCOZIA) A DIMOSTRAZIONE DELLA CONFORMITÀ DEGLI STESSI ALLE NORMATIVE TECNICHE IN VIGORE IN UK. UK CONFORMITY ASSESSTMENT AND EUROPEAN CERTIFICATION



PRODOTTI COSTRUITI CON MATERIALE RICICLABILE / PRODUCTS MADE OF RECYCLABLE MATERIAL



GARANZIA DI 5 ANNI / 5-YEAR WARRANTY



FISSO / FIXED



ORIENTABILE / ADJUSTABLE







DIAMETRO DISPONIBILE 114 MM / AVAILABLE DIAMETER 114 MM





IDONEI PER CARTONGESSO | SUITABLE FOR PLASTERBOARD

KELVIN

27		2700°K
30		3000°K
35		3500°K
40		4000°K

FASCIO / BEAM

S		SPOT
F		FLOOD
W		WIDE

FINITURE PREMIUM / PREMIUM FINISHINGS

/ 81		ORO ROSA ROSE GOLD
/ 82		BRONZO ANTICATO/ANTIQUE BRONZE
/ 83		OTTONE BRUNITO SPAZZOLATO/ BRUSHED BURNISHED BRASS

CURVE FOTOMETRICHE / PHOTOMETRIC DATA

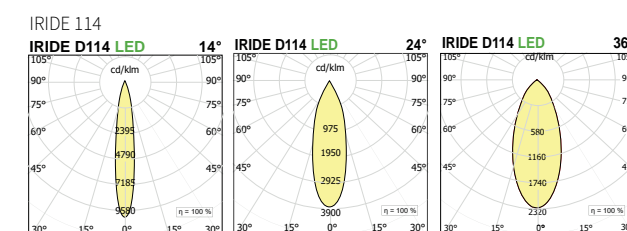

IRIDE INCASSO

CARTONGESSO | PLASTERBOARD



FINITURA PREMIUM | PREMIUM FINISHING



VERSIONI DISPONIBILI / AVAILABLE VERSION

- KELVIN**
 - 27 2700K
 - 30 3000K
 - 35 3500K
 - 40 4000K
- FASCIO / BEAM**
 - S Spot 14°
 - F Flood 24°
 - W Wide 36°

COMPOSIZIONE CODICE: xxx.x ●● / ##
HOW TO CREATE THE CODE: F1000.827S / 01

CODE
F1000.8 ● ● / ## — finishing
base code kelvin beam

/ ## FINITURA | FINISHING

- / 01 bianco - anello bianco | white - white ring
- / 02 nero - anello nero | black - black ring
- / 21 bianco - anello cromo | white - chrome ring
- / 25 nero - anello cromo | black - chrome ring
- / 28 bianco - anello nero | white - black ring

700 900 DRIVERS VEDI | SEE P.452

FISSO FRAME | FRAME FIXED

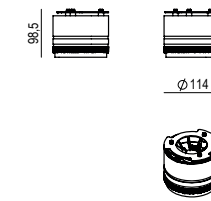

LED W	mA	Ø	Im product/beam 3000K S14° F24° W36°	CODE
26	700	114	2118 2531 2108	IR20.9 ●● / ##
34	900	114	2476 2942 2596	IR21.9 ●● / ##

700 900 IP20 CRI >90 LED 100% 5 UK CA CE
taglio per incasso / recessed hole dimension Ø 130

ORIENTABILE FRAME | FRAME ADJUSTABLE

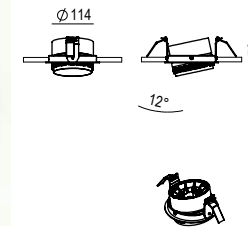

LED W	mA	Ø	Im product/beam 3000K S14° F24° W36°	CODE
26	700	114	2118 2531 2108	IR22.9 ●● / ##
34	900	114	2476 2942 2596	IR23.9 ●● / ##

700 900 IP20 CRI >90 LED 100% 5 UK CA CE
taglio per incasso / recessed hole dimension Ø 130

FISSO MINIMAL | MINIMAL FIXED

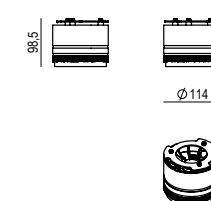

LED W	mA	Ø	Im product/beam 3000K S14° F24° W36°	CODE
26	700	114	2118 2531 2108	IR24.9 ●● / ##
34	900	114	2476 2942 2596	IR25.9 ●● / ##

700 900 IP20 CRI >90 LED 100% 5 UK CA CE
taglio per incasso / recessed hole dimension Ø 130

ACCESSORIO OBBLIGATORIO CASSAFORMA IR24.CC / MANDATORY ACCESSORY WALLBOX IR24.CC

ORIENTABILE MINIMAL | MINIMAL ADJUSTABLE

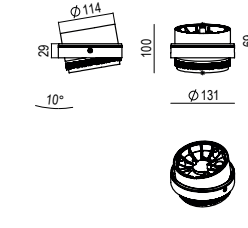

LED W	mA	Ø	Im product/beam 3000K S14° F24° W36°	CODE
26	700	114/131	2118 2531 2108	IR26.9 ●● / ##
34	900	114/131	2476 2942 2596	IR27.9 ●● / ##

700 900 IP20 CRI >90 LED 100% 5 UK CA CE
taglio per incasso / recessed hole dimension Ø 143

ACCESSORIO OBBLIGATORIO CASSAFORMA IR26.CC / MANDATORY ACCESSORY WALLBOX IR26.CC

ACCESSORIO OBBLIGATORIO CASSAFORMA PER CARTONGESSO

ACCESSORY MANDATORY WALLBOX FOR PLASTERBOARD

5 UK CA CE

taglio per incasso / recessed hole dimension Ø 138

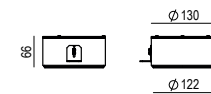

CODE
IR24.CC

TELAIO PER CARTONGESSO FRAME FOR PLASTERBOARD

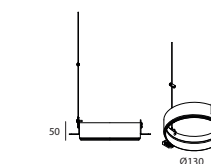

13-20

taglio per incasso / recessed hole dimension Ø 140

CODE
LTN09A

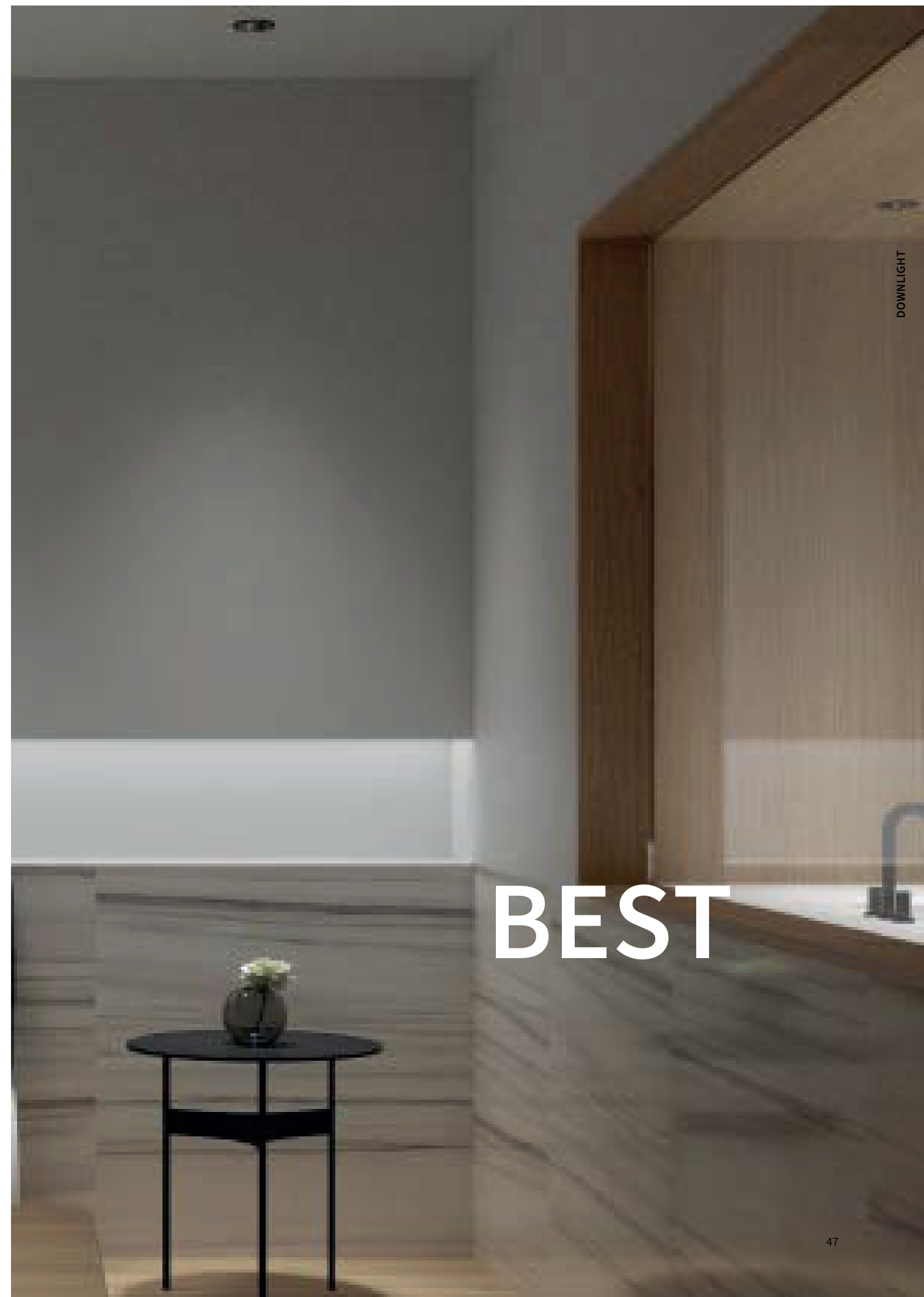

DOWNLIGHT

BEST



Apparecchi da incasso fisso o orientabile in pressofusione di alluminio verniciata, con sorgente LED integrata. Il modulo e' facilmente removibile senza l'utilizzo di attrezzi per agevolare il montaggio e l'eventuale manutenzione. Alimentatori disponibili come accessorio. Cornice di battuta disponibile bianca e nera. Grado di protezione IP20.

Recessed ceiling fixed and adjustable luminaires, made in die casted aluminum, painted by powder coating. Integrated LED source. The light engine can be removed without using any tool for an easy assemble and in case of maintenance. Power supplies available as accessories. The front trim is available in white and black. IP20.



MARCHIO DI PRODOTTO DEL REGNO UNITO CHE DEVE ESSERE UTILIZZATO PER I PRODOTTI IMMESSI SUL MERCATO IN GRAN BRETAGNA (INGHILTERRA, GALLES E SCOZIA) A DIMOSTRAZIONE DELLA CONFORMITÀ DEGLI STESSI ALLE NORMATIVE TECNICHE IN VIGORE IN UK. UK CONFORMITY ASSESSTMENT AND EUROPEAN CERTIFICATION



PRODOTTI COSTRUITI CON MATERIALE RICICLABILE / PRODUCTS MADE OF RECYCLABLE MATERIAL



GARANZIA DI 5 ANNI / 5-YEAR WARRANTY



FISSO / FIXED



ORIENTABILE / ADJUSTABLE



DIAMETRO PRODOTTO / PRODUCT DIAMETER 65 mm - 83 mm - 105 mm



IDONEI PER CARTONGESSO OR LATERIZIO / CALCESTRUZZO a seconda dei modelli e degli accessori. SUITABLE FOR PLASTERBOARD OR BRICKWALL / CONCRETE it depends on the model and its accessories.

KELVIN

27		2700°K
30		3000°K
35		3500°K
40		4000°K

FASCIO / BEAM

S		SPOT
F		FLOOD
W		WIDE

FINITURE STANDARD / STANDARD FINISHINGS

/ 01		BIANCO / WHITE
/ 02		NERO / BLACK

BEST FRAME



VERSIONI DISPONIBILI / AVAILABLE VERSION

- **KELVIN**
- 27 2700K
- 30 3000K
- 35 3500K
- 40 4000K



- **FASCIO / BEAM**
- F Flood 24°
- W Wide 38°



- **PARABOLA / REFLECTOR**
- B Bianco / White
- N Nero / black
- L Lucido / Polished

FINITURA | FINISHING

- /01 bianco | white
- /02 nero | black

COMPOSIZIONE CODICE: xxx.x ●●● /##

HOW TO CREATE THE CODE: **F1000.827SX / 01**

CODE
F1000.8 ●●● /## finishing

base code kelvin beam reflector dimmable

PARABOLA U / U REFLECTOR



Wallwasher lucido / polished wallwasher

150 300 500 DRIVERS VEDI | SEE P.452

55 FISSO | FIXED

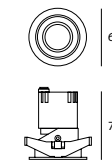

ORIENTABILE | ADJUSTABLE

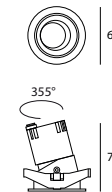

75 FISSO | FIXED

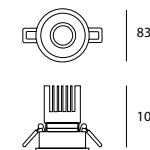

ORIENTABILE | ADJUSTABLE

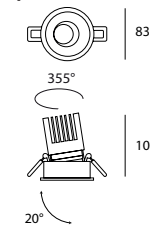

95 FISSO | FIXED

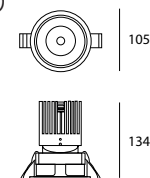

ORIENTABILE | ADJUSTABLE

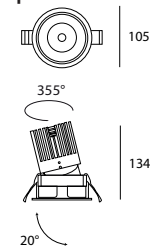

taglio per incasso / recessed hole dimension ∅ 55

NOTE: COMPLETARE CON DRIVER | DRIVER NOT INCLUDED 150 IP20 CRI >90 5 UK CE

LED	W	mA	∅	H	Kg	lm product/beam 3000K	F24°	W38°	CODE
5	120	65	76	0,49	650	650			BT550.9 ●●● /##

WALLWASHER

LED	W	mA	∅	H	Kg	lm product/beam 3000K	F24°	W38°	CODE
5	120	65	76	0,49	650	650			BT550.9 ●●● U /##

taglio per incasso / recessed hole dimension ∅ 75

NOTE: COMPLETARE CON DRIVER | DRIVER NOT INCLUDED 300 IP20 CRI >90 5 UK CE

LED	W	mA	∅	H	Kg	lm product/beam 3000K	F24°	W38°	CODE
12	300	83	100	0,49	1560	1560			BT750.9 ●●● /##

WALLWASHER

LED	W	mA	∅	H	Kg	lm product/beam 3000K	F24°	W38°	CODE
12	300	83	100	0,49	1560	1560			BT750.9 ●●● U /##

taglio per incasso / recessed hole dimension ∅ 95

NOTE: COMPLETARE CON DRIVER | DRIVER NOT INCLUDED 500 IP20 CRI >90 5 UK CE

LED	W	mA	∅	H	Kg	lm product/beam 3000K	F24°	W38°	CODE
20	500	105	134	0,49	2600	2600			BT950.9 ●●● /##

WALLWASHER

LED	W	mA	∅	H	Kg	lm product/beam 3000K	F24°	W38°	CODE
20	500	105	134	0,49	2600	2600			BT950.9 ●●● U /##

LED	W	mA	∅	H	Kg	lm product/beam 3000K	F24°	W38°	CODE
20	500	105	134	0,49	2600	2600			BT951.9 ●●● /##

BEST

MINIMAL



VERSIONI DISPONIBILI / AVAILABLE VERSION

- **KELVIN**
- 27 2700K
- 30 3000K
- 35 3500K
- 40 4000K

- **FASCIO / BEAM**
- F Flood 24°
- W Wide 38°

- **PARABOLA / REFLECTOR**
- B Bianco / White
- N Nero / black
- L Lucido / Polished

COMPOSIZIONE CODICE: xxx.x●●●/##

HOW TO CREATE THE CODE: **F1000.827SX / 01**

CODE
F1000.8 | ● | ● | ● | /## finishing
 base code | kelvin | beam | reflector

PARABOLA U / U REFLECTOR

- Wallwasher lucido / polished wallwasher

150 300 500 DRIVERS VEDI | SEE P.452

MINIMAL 55 FISSO | FIXED

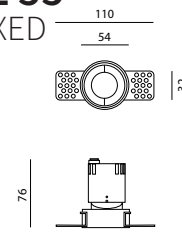

ORIENTABILE | ADJUSTABLE

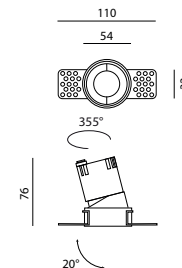

MINIMAL 75 FISSO | FIXED

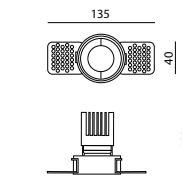

ORIENTABILE | ADJUSTABLE

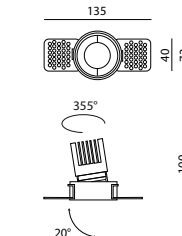

MINIMAL 95 FISSO | FIXED

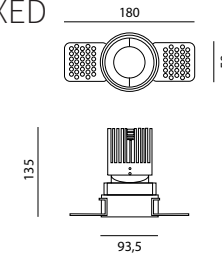

ORIENTABILE | ADJUSTABLE

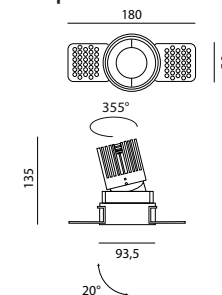

taglio per incasso / recessed hole dimension \varnothing 55

NOTE: COMPLETARE CON DRIVER | DRIVER NOT INCLUDED



LED W	mA	∅	H	Kg	lm product/beam 3000K F24° W38°	CODE
5	120	65	76	0,49	650 650	BT552.9 ●●●

WALLWASHER

LED W	mA	∅	H	Kg	lm product/beam 3000K F24° W38°	CODE
5	120	65	76	0,49	650 650	BT552.9 ●●● U

taglio per incasso / recessed hole dimension \varnothing 75

NOTE: COMPLETARE CON DRIVER | DRIVER NOT INCLUDED



LED W	mA	∅	H	Kg	lm product/beam 3000K F24° W38°	CODE
12	300	83	100	0,49	1560 1560	BT752.9 ●●●

WALLWASHER

LED W	mA	∅	H	Kg	lm product/beam 3000K F24° W38°	CODE
12	300	83	100	0,49	1560 1560	BT752.9 ●●● U

taglio per incasso / recessed hole dimension \varnothing 95

NOTE: COMPLETARE CON DRIVER | DRIVER NOT INCLUDED



LED W	mA	∅	H	Kg	lm product/beam 3000K F24° W38°	CODE
20	500	105	134	0,49	2600 2600	BT952.9 ●●●

WALLWASHER

LED W	mA	∅	H	Kg	lm product/beam 3000K F24° W38°	CODE
20	500	105	134	0,49	2600 2600	BT952.9 ●●● U

LED W	mA	∅	H	Kg	lm product/beam 3000K F24° W38°	CODE
20	500	105	134	0,49	2600 2600	BT952.9 ●●●

LED W	mA	∅	H	Kg	lm product/beam 3000K F24° W38°	CODE
20	500	105	134	0,49	2600 2600	BT952.9 ●●● U

I-KONE

FRAME RECESSED



FISSO | FIXED



INCLINABILE | ADJUSTABLE



FISSO | FIXED

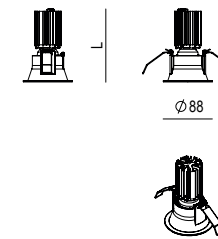
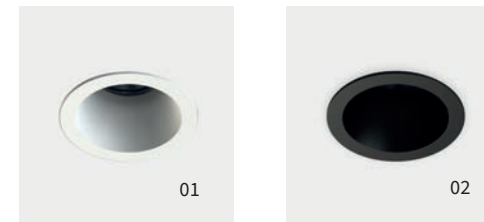

LED		Im product/beam 3000K		CODE	
W	mA	ø	H	F27°	W46°
8	250	88	111	860	860
12	350	88	111	1285	1285

250 350

IK006.9 ●● / ##

LED		Im product/beam 3000K		CODE	
W	mA	ø	H	F27°	W46°
12	350	88	131	1285	1289
18	500	88	131	1575	1579

350 500

IK007.9 ●●● / ##

GU10		CODE	
W	ø.mm	Hmm	Kg
50	88	94	0.21

IK008 / ##

NOTE: COMPLETARE CON DRIVER | DRIVER NOT INCLUDED DISPONIBILI ANCHE VERSIONI 2700 / 4000K E FINITURA NERA / 02 | AVAILABLE VERSION 2700 / 4000K AND BLACK / 02 | FINISHING

taglio per incasso / recessed hole dimension \varnothing 80
spazio per passaggio alimentatore / necessary space to insert driver \varnothing 80



INCLINABILE | ADJUSTABLE

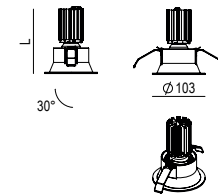
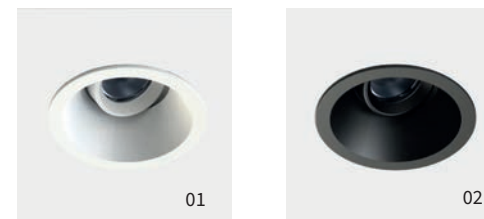

LED		Im product/beam 3000K		CODE	
W	mA	ø	H	F27°	W46°
8	250	103	111	860	860
12	350	103	111	1285	1285

250 350

IK010.9 ●●● / ##

LED		Im product/beam 3000K		CODE	
W	mA	ø	H	F27°	W46°
12	350	103	131	1285	1285
18	500	103	131	1575	1579

350 500

IK011.9 ●●● / ##

GU10		CODE	
W	ø.mm	Hmm	Kg
50	103	94	0.21

IK012 / ##

NOTE: COMPLETARE CON DRIVER | DRIVER NOT INCLUDED DISPONIBILI ANCHE VERSIONI 2700 / 4000K E FINITURA NERA / 02 | AVAILABLE VERSION 2700 / 4000K AND BLACK / 02 | FINISHING

taglio per incasso / recessed hole dimension \varnothing 90
spazio per passaggio alimentatore / necessary space to insert driver \varnothing 90

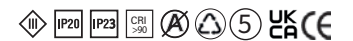

VERSIONI DISPONIBILI / AVAILABLE VERSION

- KELVIN
- 27 2700K
- 30 3000K
- 35 3500K
- 40 4000K
- FASCIO / BEAM
- F Flood 27°
- W Wide 46°
- ## FINITURA | FINISHING
- / 01 bianco | white
- / 02 nero | black

COMPOSIZIONE CODICE: xxx.x ●● / ##

HOW TO CREATE THE CODE: F1000.827S / 01

CODE
F1000.8 ●● / ## — finishing
base code kelvin beam

250 350 500 DRIVERS VEDI | SEE P.452

I-KONE

MINIMAL RECESSED



FISSO | FIXED



INCLINABILE | ADJUSTABLE



FISSO | FIXED

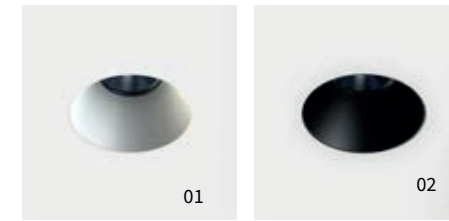

NOTE: COMPLETARE CON DRIVER | DRIVER NOT INCLUDED

taglio per incasso / recessed hole dimension \varnothing 77
spazio per passaggio alimentatore / necessary space to insert driver \varnothing 46

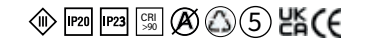

LED		W	mA	\varnothing	H	α	Kg	lm product / beam 3000K	CODE
								F27° W46°	
8	250	86	106	20	0,35	860	860	IK000.9	●● / ##
12	350	86	106	20	0,35	1285	1285		

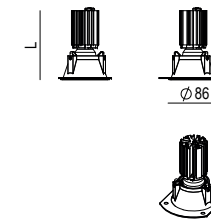

LED		W	mA	\varnothing	H	α	Kg	lm product / beam 3000K	CODE
								F27° W46°	
12	350	86	126	20	0,35	1285	1285	IK001.9	●● / ##
18	500	86	126	20	0,35	1575	1579		

GU10

W	\varnothing .mm	Hmm	Kg	CODE
50	86	99	0.21	IK002

INCLINABILE | ADJUSTABLE



NOTE: COMPLETARE CON DRIVER | DRIVER NOT INCLUDED

taglio per incasso / recessed hole dimension \varnothing 70
spazio per passaggio alimentatore / necessary space to insert driver \varnothing 46

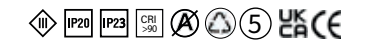

LED		W	mA	\varnothing	L	α	Kg	lm product / beam 3000K	CODE
								F27° W46°	
8	250	84	98	30	0,35	860	860	IK003.9	●● / ##
12	350	84	98	30	0,35	1285	1285		

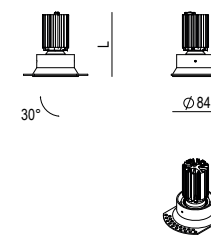

LED		W	mA	\varnothing	H	α	Kg	lm product / beam 3000K	CODE
								F27° W46°	
12	350	84	118	30	0,35	1285	1285	IK004.9	●● / ##
18	500	84	118	30	0,35	1575	1579		

GU10

W	\varnothing .mm	Hmm	Kg	CODE
50	84	94	0.21	IK005 / ##

VERSIONI DISPONIBILI / AVAILABLE VERSION

- KELVIN
- FASCIO / BEAM
- ## FINITURA | FINISHING
- 27 2700K
- 30 3000K
- 35 3500K
- 40 4000K
- F Flood 27°
- W Wide 46°
- / 01 bianco | white
- / 02 nero | black

COMPOSIZIONE CODICE: xxx.x ●● / ##

HOW TO CREATE THE CODE: F1000.827S / 01

CODE
F1000.8 ●● / ## — finishing
base code kelvin beam

250 350 500 DRIVERS VEDI | SEE P.452 57

I-SQUARE RECESSED



FISSO | FIXED



INCLINABILE | ADJUSTABLE



FISSO | FIXED

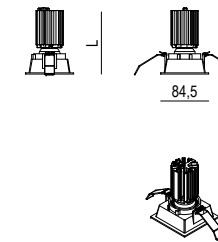
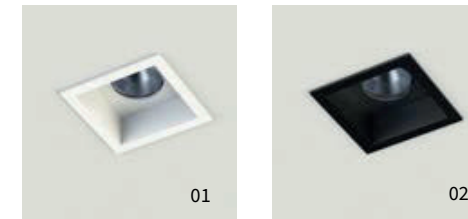

NOTE: COMPLETARE CON DRIVER | DRIVER NOT INCLUDED DISPONIBILI ANCHE VERSIONI 2700 / 4000K E FINITURA NERA / 02 | AVAILABLE VERSION 2700 / 4000K AND BLACK / 02 | FINISHING

taglio per incasso / recessed hole dimension 77X77



LED		Im product/beam 3000K		CODE			
W	mA	LxW	H	F27°	W46°		
8	250	84.5X84.5	95	0,35	860	860	IS013.9 ●● / ##
12	350	84.5X84.5	95	0,35	1285	1285	

LED		Im product/beam 3000K		CODE			
W	mA	mm	H	F27°	W46°		
12	350	84.5X84.5	115	0,35	1285	1285	IS014.9 ●● / ##
18	500	84.5X84.5	115	0,35	1575	1575	

GU10		CODE		
W	LxW	Hmm	Kg	
50	84.5X84.5	94	0.21	IS015

INCLINABILE | ADJUSTABLE

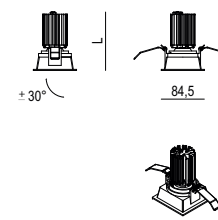
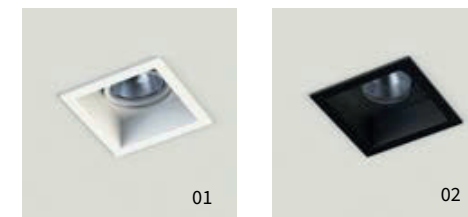

NOTE: COMPLETARE CON DRIVER | DRIVER NOT INCLUDED DISPONIBILI ANCHE VERSIONI 2700 / 4000K E FINITURA NERA / 02 | AVAILABLE VERSION 2700 / 4000K AND BLACK / 02 | FINISHING

taglio per incasso / recessed hole dimension 77X77

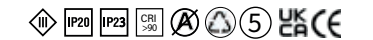

LED		Im product/beam 3000K		CODE				
W	mA	mm	H	α	Kg			
8	250	84.5X84.5	95	30	0,35	860	860	IS016.9 ●● / ##
12	350	84.5X84.5	95	30	0,35	1285	1285	

LED		Im product/beam 3000K		CODE				
W	mA	mm	H	α	Kg			
12	350	84.5X84.5	115	30	0,35	1285	1285	IS017.9 ●● / ##
18	500	84.5X84.5	115	30	0,35	1575	1575	

GU10		CODE		
W	mm	Hmm	Kg	
50	84.5X84.5	94	0.21	IS017

VERSIONI DISPONIBILI / AVAILABLE VERSION

- KELVIN
- FASCIO / BEAM
- / ## FINITURA | FINISHING
- 27 2700K
- 30 3000K
- 35 3500K
- 40 4000K
- F Flood 27°
- W Wide 46°
- / 01 bianco | white
- / 02 nero | black

COMPOSIZIONE CODICE: xxx.x ●● /

HOW TO CREATE THE CODE: F1000.827S / 01

CODE
F1000.8 | ●● | ## | — finishing
base code kelvin beam

250 350 500 DRIVERS VEDI | SEE P.452 59

CONVEX



FISSO | FIXED

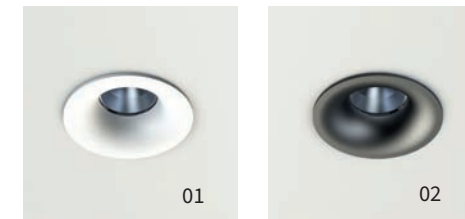

taglio per incasso / recessed hole dimension \varnothing 75
 spazio per passaggio alimentatore / necessary space to insert driver \varnothing 75



LED		W	mA	\varnothing	H	Kg	lm product/beam 3000K	W46°	CODE
	\varnothing 84	8	250	84	90	0,35	860	860	CV018.9 ●● / ##
		12	350	84	90	0,35	1285	1285	

LED		W	mA	\varnothing	H	Kg	lm product/beam 3000K	W46°	CODE
		12	350	84	110	0,35	1285	1285	CV019.9 ●● / ##
		18	500	84	110	0,35	1575	1575	

GU10		W	\varnothing .mm	Hmm	Kg	CODE
		50	84	110	0.21	CV020

NOTE: COMPLETARE CON DRIVER | DRIVER NOT INCLUDED



ACCESSORIO PER TRASFORMARE CONVEX IN VERSIONE TRIMLESS ACCESSORY TO TRANSFORM CONVEX IN TRIMLESS RECESSED



\varnothing ESTERNO / EXTERNAL 100 mm

CODE
CV030



VERSIONI DISPONIBILI / AVAILABLE VERSION

- **KELVIN**
 - 27 2700K
 - 30 3000K
 - 35 3500K
 - 40 4000K
- **FASCIO / BEAM**
 - F** Flood 27°
 - W** Wide 46°
- / ## **FINITURA** | FINISHING
 - / 01 bianco | white
 - / 02 nero | black

COMPOSIZIONE CODICE: xxx.x ●● / ##
 HOW TO CREATE THE CODE: **F1000.827S / 01**

CODE
F1000.8 ●● / ## finishing
 base code kelvin beam

250 350 500 DRIVERS VEDI | SEE P.452

STICK

FISSO CON PIATTELLO | FIXED RECESSED WITH PLATE

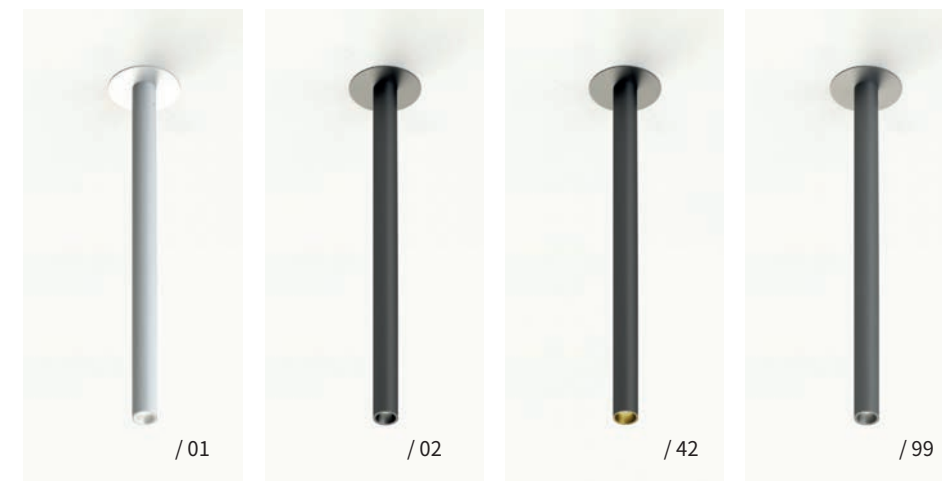
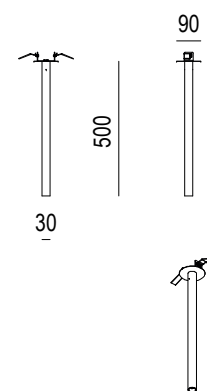

700 LED IP20 CRI >90 5 UKCA CE
taglio per incasso / recessed hole dimension \varnothing 75

LED				lm product / beam 3000K		
W	mA	\varnothing	H	S28°	F40°	CODE
8	700	30	500	695	720	SK000.9 ●● / ##

DOWNLIGHT

ORIENTABILE | ADJUSTABLE

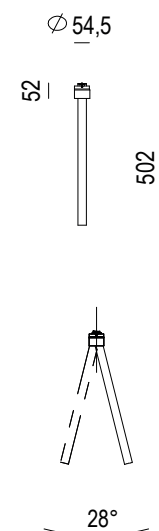

700 LED IP20 CRI >90 5 UKCA CE

LED				lm product / beam 3000K		
W	mA	\varnothing	H	S28°	F40°	CODE
8	700	30	500	695	720	SK010.9 ●● / ##

VERSIONI DISPONIBILI / AVAILABLE VERSION

- **KELVIN**
- 27 2700K
- 30 3000K
- 35 3500K
- 40 4000K

● FASCIO / BEAM

- **S** Spot
- **F** Flood

Per i gradi vedere in tabella -
For degrees check the table

- **/## FINITURA | FINISHING**
- /01 bianco / white
- /02 nero / black
- /42 nero e oro / black & gold
- /99 grafite / graphite

PREMIUM FINISHING AVAILABLE

COMPOSIZIONE CODICE: xxx.x ●● / ##
HOW TO CREATE THE CODE: **F1000.827S / 01**

CODE
F1000.8 | ●● | /## finishing
base code | kelvin | beam

700 DRIVERS VEDI | SEE P.452

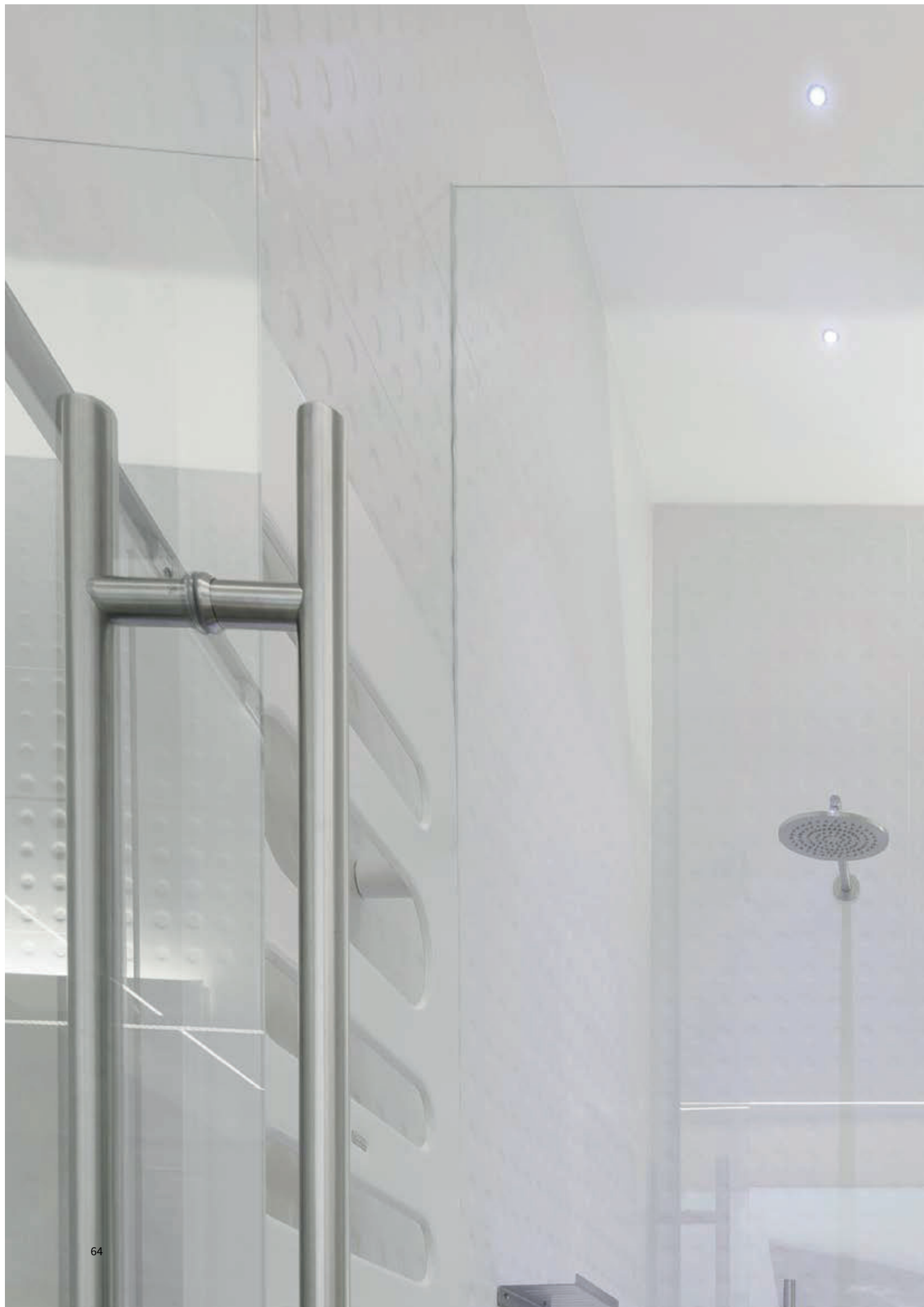

SPOTTINO



SPOTTINO

Apparecchio da incasso per cartongesso, rasato a scomparsa totale per un'illuminazione d'accento. Caratterizzato da un aspetto minimale ma di grande impatto visivo, con dimensioni estremamente ridotte. Sorgente luminosa in posizione arretrata antiabbagliamento. L'alimentazione è da posizionare remota. Il grado di protezione è IP40/43

Built-in plasterboard luminaire, fully concealed, for accent lighting. Characterized by a minimal appearance but of great visual impact, with extremely small dimensions. Light source in back anti-glare position. The power supply is to be positioned remotely. The degree of protection is IP40/43.

SPOTTINO 26

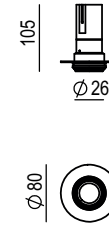

CARTONGESSO/PLASTERBOARD

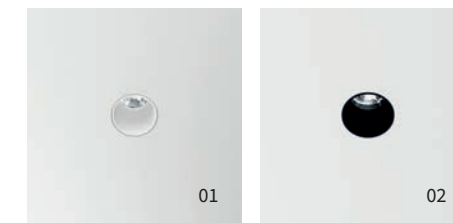

LED W	mA	ø	H	lm product / beam 3000K	CODE
5,7	500	26	105	F27° 571	SO026.9 ● F /##

● disponibile solo fascio F available only F beam

SPOTTINO 36

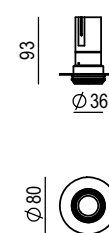

CARTONGESSO/PLASTERBOARD

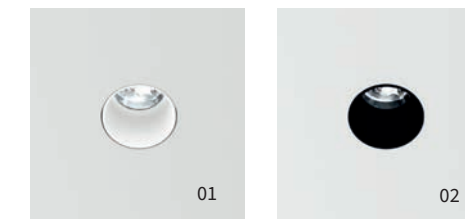

LED W	mA	ø	H	lm product / beam 3000K	CODE
8	700	36	93	S19° F28° 665 695	SO036.9 ● ● /##

VERSIONI DISPONIBILI / AVAILABLE VERSION

- **KELVIN**
- 27 2700K
- 30 3000K
- 35 3500K
- 40 4000K
- TW Tunable White Dali

● **FASCIO / BEAM**

- S Spot
- F Flood

Per i gradi vedere in tabella - For degrees check the table

/## **FINITURA** | FINISHING

- /01 bianco | white
- /02 nero | black

/## **FINITURE PREMIUM** / PREMIUM FINISHING

- /81 oro rosa/rose gold
- /82 bronzo anticato /antique bronze
- /83 ottone brunito spazzolato/ brushed burnished brass

COMPOSIZIONE CODICE: xxx.x ● ● /##

HOW TO CREATE THE CODE: F1000.827S / 01

CODE
F1000.8 | ● | ● | /## — finishing
base code kelvin beam

500 700 DRIVERS VEDI | SEE P.452



CI

CI

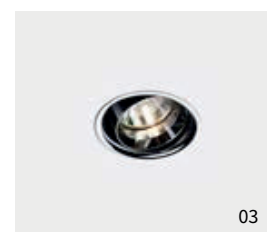
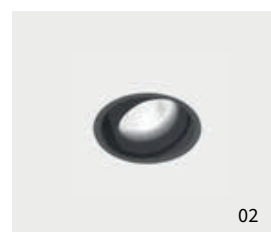
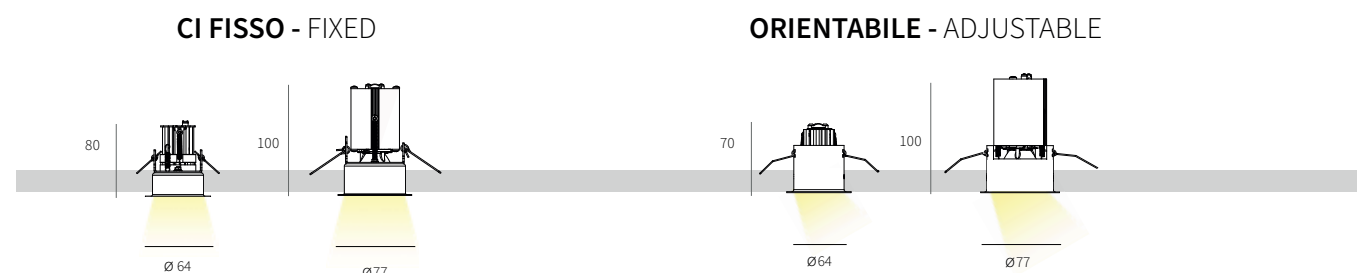

MARCHIO DI PRODOTTO DEL REGNO UNITO CHE DEVE ESSERE UTILIZZATO PER I PRODOTTI IMMESSI SUL MERCATO IN GRAN BRETAGNA (INGHILTERRA, GALLES E SCOZIA) A DIMOSTRAZIONE DELLA CONFORMITÀ DEGLI STESSI ALLE NORMATIVE TECNICHE IN VIGORE IN UK. UK CONFORMITY ASSESSTMENT AND EUROPEAN CERTIFICATION



PRODOTTI COSTRUITI CON MATERIALE RICICLABILE / PRODUCTS MADE OF RECYCLABLE MATERIAL



GARANZIA DI 5 ANNI / 5-YEAR WARRANTY



FISSO / FIXED



ORIENTABILE / ADJUSTABLE



DIAMETRO PRODOTTO / PRODUCT DIAMETER 64 mm / DIAM. 77 mm



IDONEI PER CARTONGESSO OR LATERIZIO / CALCESTRUZZO a seconda dei modelli e degli accessori. SUITABLE FOR PLASTERBOARD OR BRICKWALL / CONCRETE it depends on the model and its accessories.

KELVIN	FASCIO / BEAM
27	F FLOOD
30	W WIDE
35	
40	

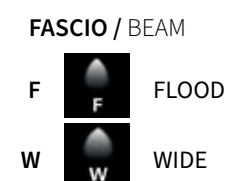

FINITURE STANDARD / STANDARD FINISHINGS

/01	BIANCO / WHITE
/02	NERO / BLACK
/03	CROMO / CHROME

FINITURE PREMIUM / PREMIUM FINISHINGS

/81	ORO ROSA / ROSE GOLD
/82	BRONZO ANTICATO / ANTIQUE BRONZE
/83	OTTONE BRUNITO SPAZZOLATO / BRUSHED BURNISHED BRASS

Apparecchi da incasso a soffitto, fissi od orientabili, con sorgente LED integrata o per lampade GU10 230 / 240V. Alimentatori, da posizionarsi in remoto, disponibili come accessorio. Corpo, cornice di battuta e gruppo ottico in metallo verniciato o cromato. Installabile anche in soffitti in calcestruzzo o laterizio mediante apposita cassaforma in lamiera zincata disponibile come accessorio. Grado di protezione IP20.

Recessed ceiling luminaires, fixed or adjustable, with integrated LED source or for GU10 230 / 240V light bulbs. Power supplies, to be positioned remotely, available as accessories. Body, trimmed frame and optical group in painted metal or chromed. It can, also, be installed in concrete or brick ceilings using a special galvanized metal outercasing available as accessory. IP20.

CURVE FOTOMETRICHE / PHOTOMETRIC DATA

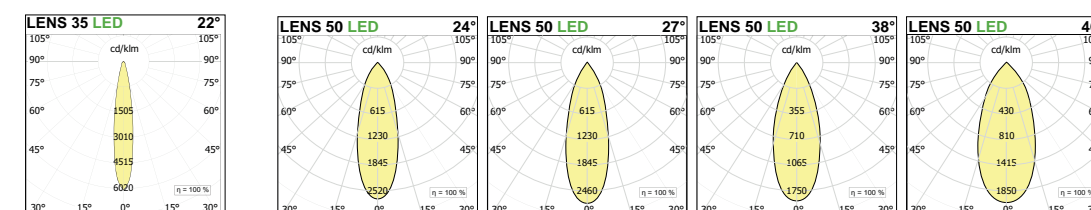



CI INCASSO | RECESSED

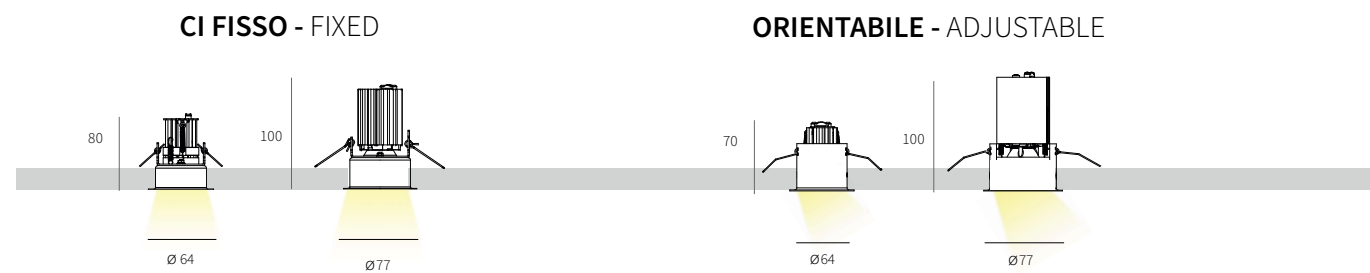

VERSIONI DISPONIBILI / AVAILABLE VERSION

- **KELVIN**
- 27 2700K
- 30 3000K
- 35 3500K
- 40 4000K

- **FASCIO / BEAM**
- S Spot
- F Flood
- W Wide

Per i gradi vedere in tabella -
For degrees check the table

/ ## FINITURA | FINISHING

- / 01 bianco | white
- / 02 nero | black
- / 03 cromo | chrome (solo orientabile/only adjustable)

/ ## FINITURA PREMIUM / PREMIUM FINISHING

- / 81 oro rosa | rose gold
- / 82 bronzo antico | antique bronze
- / 83 ottone brunito spazzolato | brushed burnished brass

COMPOSIZIONE CODICE: xxx.x ●● / ##
HOW TO CREATE THE CODE: **F1000.827S / 01**

CODE
F1000.8 ●● / ## — finishing
base code kelvin beam

350 500

CI FISSO - FIXED



CI 35

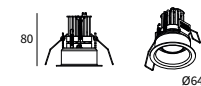

Per cartongesso o laterizio -
Suitable for plasterboard and
brickwall.

CI 50

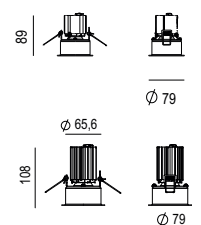

Per cartongesso o laterizio -
Suitable for plasterboard
and brickwall.

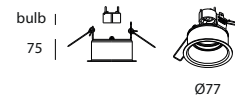

Per cartongesso o laterizio -
Suitable for plasterboard and
brickwall.

taglio per incasso / recessed hole dimension \varnothing 56

LED						CODE
W	mA	\varnothing mm	Hmm	lm prod 3000k / beam F22°		
5	500	64	80	520		LT1167.9 ● F / ##

● Disponibile solo fascio F | Available only F beam

Accessori - accessories: LT9061: cassaforma CI35 / 35F - wallbox CI35 e CI35 / 35F

taglio per incasso / recessed hole dimension \varnothing 70

LED							CODE
W	mA	\varnothing mm	Hmm	lm product/beam 3000K			
8	250	79	89	860	F27° W46°	860	LT1183.9 ●● / ##
12	350	79	89	1285	1285		

LED							CODE
W	mA	\varnothing mm	Hmm	F27°	W46°		
12	350	79	108	1285	1289		LT1166.9 ●● / ##
18	500	79	108	1575	1579		

GU10LED				CODE
W	\varnothing mm	Hmm		
1 x max 50	77	75		LT1165 / ##

Accessori - Accessories: LT9062.1: cassaforma CI50 / 50F - wallbox CI50 e CI50 / 50F

CI ORIENTABILE - ADJUSTABLE



CI 35

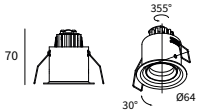

Solo per cartongesso -
Suitable only for plasterboard.

CI 50

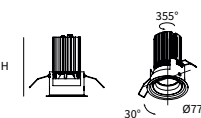

Solo per cartongesso -
Suitable only for plasterboard.

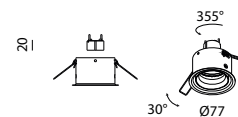

Per cartongesso o laterizio -
Suitable for plasterboard and
brickwall.

taglio per incasso / recessed hole dimension \varnothing 56

LED						CODE
W	mA	\varnothing	Hmm	lm prod 3000K beam F22°		
5	500	64	70	520		LT1163.9 ● F / ##

● Disponibile solo fascio F | Available only F beam

taglio per incasso / recessed hole dimension \varnothing 70

LED							CODE
W	mA	\varnothing	Hmm	α	lm product/beam 3000K		
8	250	77	100	30	S15° F27° W46°	860	LT1170.9 ●● / ##
12	350	77	100	30	1285	1285	

LED							CODE	
W	mA	\varnothing	Hmm	α	S15°	F27°		
12	350	77	120	30	1285	1285	1289	LT1168.9 ●● / ##
18	500	77	120	30	1575	1575	1579	

GU10LED				CODE
W	\varnothing mm	Hmm		
1 x max 50	77	90		LT1161 / ##

Accessori - Accessories: LT9062.1: cassaforma CI50 / 50F - wallbox CI50 e CI50 / 50F

CASSAFORMA PER INSTALLAZIONE A LATERIZIO E CALCESTRUZZO | WALLBOX FOR INSTALLING IN BRICK WALL AND CONCRETE

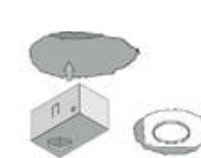
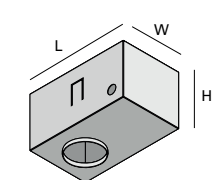

Dim. L x W mm	Hmm	CODE
CI35 190 x 114	80	LT9061
CI50 208 x 140	120	LT9062.1

Cassaforma in lamiera zincata per installazione in laterizio o calcestruzzo - galvanized metal wallbox for installing in brick or reinforced concrete



NYX

NYX

Q
QUADRATO E RASATO
SQUARE AND TRIMLESS



TF
TONDO, FISSO E RASATO
ROUND, FIXED AND TRIMLESS

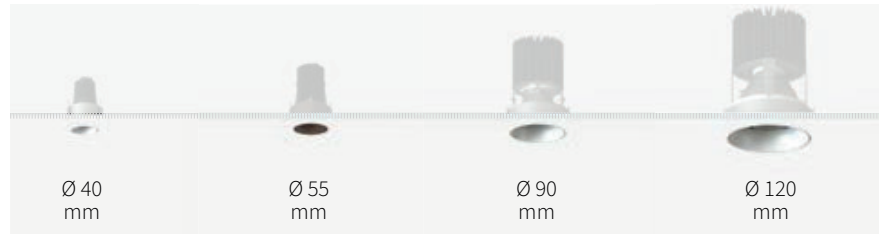

TD
TONDO, ORIENTABILE E RASATO
ROUND, ADJUSTABLE AND TRIMLESS



FRAME TF
TONDO, FISSO CON CORNICE
ROUND, FIXED WITH FRAME

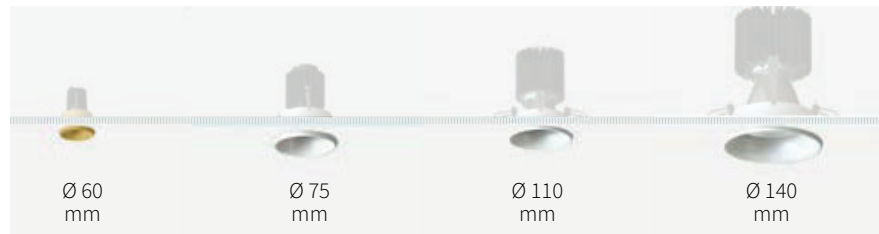

FRAME TD
TONDO, ORIENTABILE CON CORNICE
ROUND, ADJUSTABLE WITH FRAME

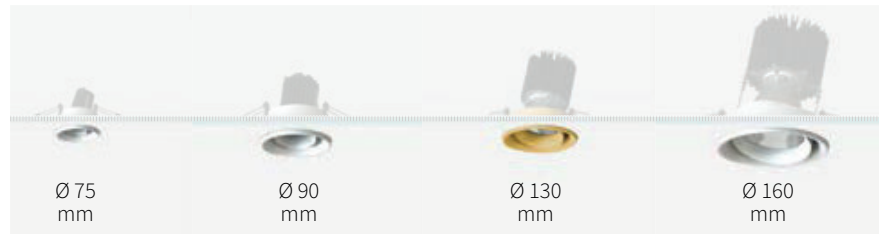

TUBE
TONDO, RASATO, REGOLABILE
ROUND, TRIMLESS AND ADJUSTABLE

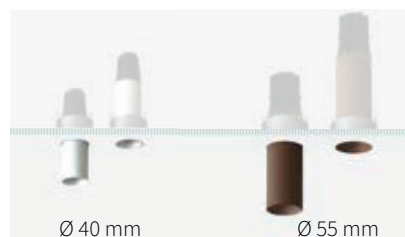

Apparecchi da incasso a soffitto trimless o con battuta, fissi ed orientabili, per illuminazione d'accento o diffusa. Sorgente luminosa in posizione arretrata anti abbagliamento. Disponibile nelle versioni per installazione in cartongesso o in laterizio e calcestruzzo mediante l'utilizzo di apposite controcasse ordinabili come accessorio. Disponibili con sorgente LED integrata o per lampade GU10 230 / 240V. Corpo e gruppo ottico in alluminio verniciato. Alimentatore remoto disponibile come accessorio. Grado di protezione IP54

Trimless or trimmed recessed ceiling luminaires, fixed and adjustable, for accent or diffused lighting. Light source in anti-glare recessed position. Available for plasterboard installation or brick and concrete through the use of special outercases to be ordered separately. Powered with integrated LED source or for GU10 230 / 240V light bulbs. Body and optical group in painted aluminum. Remote power supply available as an accessory. IP54



UK CONFORMITY ASSESSMENT E EUROPEAN CERTIFICATION / UK CONFORMITY ASSESSMENT AND EUROPEAN CERTIFICATION



PRODOTTI COSTRUITI CON MATERIALE RICICLABILE / PRODUCTS MADE OF RECYCLABLE MATERIAL



GARANZIA DI 5 ANNI / 5-YEAR WARRANTY



FISSO / FIXED



ORIENTABILE / ADJUSTABLE



DIAMETRI DISPONIBILI DA 40 A 160 MM A SECONDA DEI MODELLI / AVAILABLE DIAMETERS FROM 40 TO 160 MM IT DEPENDS ON THE MODEL



IDONEI PER CARTONGESSO O LATERIZIO / CALCESTRUZZO a seconda dei modelli e degli accessori. SUITABLE FOR PLASTERBOARD OR BRICKWALL / CONCRETE it depends on the model and its accessories.

KELVIN

27		2700°K
30		3000°K
35		3500°K
40		4000°K

FASCIO / BEAM

S		SPOT
F		FLOOD
W		WIDE

FINITURE STANDARD / STANDARD FINISHINGS

/ 01		BIANCO / WHITE
/ 02		NERO / BLACK
/ 36		ORO / GOLD
/ 49		BRONZO / BRONZE

FINITURE PREMIUM / PREMIUM FINISHINGS

/ 81		ORO ROSA / ROSE GOLD
/ 82		BRONZO ANTICATO / ANTIQUE BRONZE
/ 83		OTTONE BRUNITO SPAZZOLATO / BRUSHED BURNISHED BRASS

CURVE FOTOMETRICHE / PHOTOMETRIC DATA

NYX 35

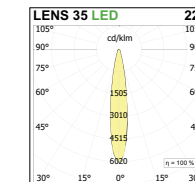

NYX 50

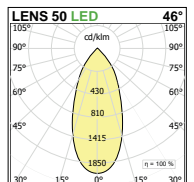
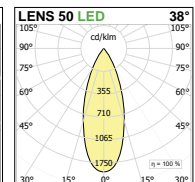
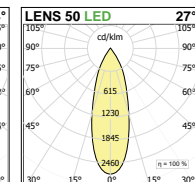
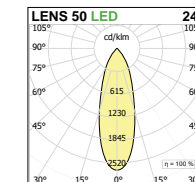

NYX 80

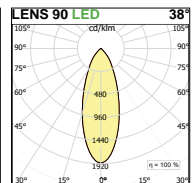
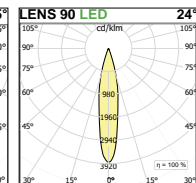
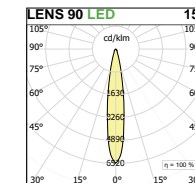

NYX 111

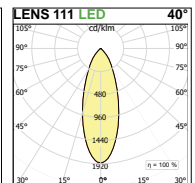
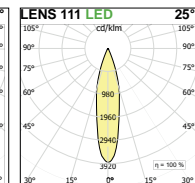
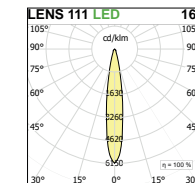

NYX 160

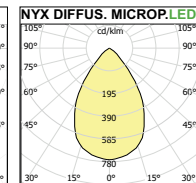
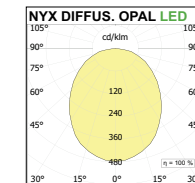

NYX

QUADRATO TRIMLESS

SQUARE TRIMLESS

DOWNLIGHT

VERSIONI / VERSIONS



FINITURE / FINISHINGS



NYX Q35

1 SCEGLIERE CASSA O TELAIO IN BASE AL TIPO DI INSTALLAZIONE / CHOOSE CASE OR FRAME ACCORDING TO THE TYPE OF INSTALLATION Ø 40

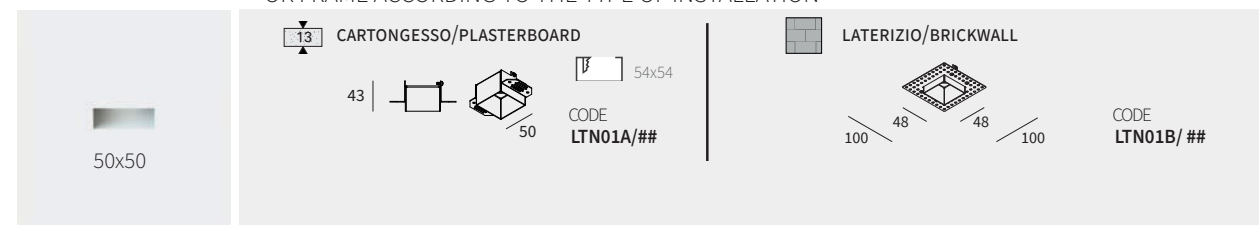

2 SCEGLIERE IL GRUPPO OTTICO / CHOOSE OPTIC GROUP

LED	W	mA	ømm	Hmm	KG	Im prod 3000k /beam F22° W38°	Im prod 3000k /beam F22° W38°	CODE
355° 30° Ø40	5	500	40	61	0,11	520	445	LTN01K.9 / ##

● Disponibile solo fascio F | Available only F beam

METODI DI INSTALLAZIONE HOW TO FIXED

CARTONGESSO/PLASTERBOARD

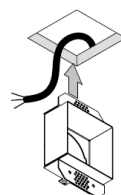

LATERIZIO/BRICKWALL

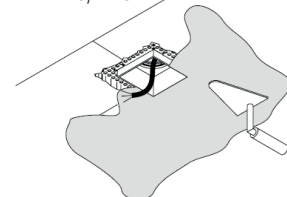

NYX Q50

1 SCEGLIERE CASSA O TELAIO IN BASE AL TIPO DI INSTALLAZIONE / CHOOSE CASE OR FRAME ACCORDING TO THE TYPE OF INSTALLATION Ø 55

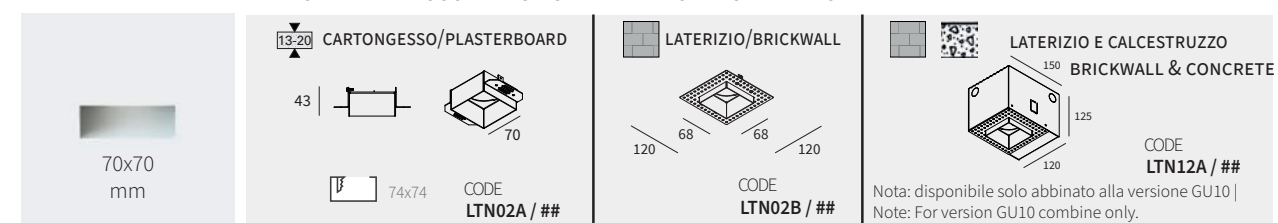

2 SCEGLIERE IL GRUPPO OTTICO / CHOOSE OPTIC GROUP

LED	W	mA	ømm	Hmm	Kg	Im product/beam 3000K S15° F27° W46°	Im product/beam 3000K S15° F27° W46°	Im product/beam 3000K S15° F27° W46°	CODE
Ø60	8	250	60	73	0,19	860	860	860	LTN88K.9 / ##
	12	350	60	73	0,19	1285	1285	1285	
	12	350	60	93	0,22	1285	1285	1289	LTN10K.9 / ##
	18	500	60	93	0,22	1575	1575	1579	

Gli apparecchi con temperatura colore Tunable White devono essere associati a driver a 2 canali. | The devices with Tunable white color temperature have to be supplied with 2 channel driver

GU10

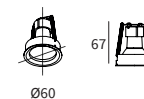

GU10 LED	W	ømm	Hmm	Kg	CODE
	50	60	67	0,09	LTN16K / ##

Accessori - accessories: L050#: lente Ø 50
Nota: Alla versione GU10 è possibile abbinare soltanto la lente L###R nido d'ape | Note: For version GU10 combine L###R honey comb only. L050R / ##" a pagina 83 | see page "L050R / ##" a pagina 83

VERSIONI DISPONIBILI / AVAILABLE VERSION

- **KELVIN**
- 27 2700K
- 30 3000K
- 35 3500K
- 40 4000K
- TW Tunable White Dali
- **FASCIO/BEAM**
- S Spot
- F Flood
- W Wide

/ ## FINITURA | FINISHING

- / 01 bianco | white
- / 02 nero | black
- / 49 bronzo | bronze

/ ## FINITURA PREMIUM | PREMIUM FINISHING

- / 81 oro rosa | rose gold
- / 82 bronzo antico | antique bronze
- / 83 ottone brunito spazzolato | brushed burnished brass

COMPOSIZIONE CODICE: xxx.x /

HOW TO CREATE THE CODE: F1000.827S / 01

CODE
F1000.8 / ## finishing
base code kelvin beam

DRIVERS VEDI | SEE P.452

NYX TF

TONDO FISSO RASATO
ROUND FIXED TRIMLESS

DOWNLIGHT

VERSIONI / VERSIONS



FINITURE / FINISHINGS



NYX T35F

1 SCEGLIERE CASSA O TELAIO IN BASE AL TIPO DI INSTALLAZIONE
CHOOSE CASE OR FRAME ACCORDING TO THE TYPE OF INSTALLATION

CARTONGESSO/PLASTERBOARD **LATERIZIO/BRICKWALL** **LED** **LED**

LED	W	mA	ømm	Hmm	Kg	Im prod/beam 3000K	CODE
5	500	40	84	0,11	520		LTN30K.9 ○ F / ##

● Disponibile solo fascio F | Available only F beam

NYX T50F

1 SCEGLIERE CASSA O TELAIO IN BASE AL TIPO DI INSTALLAZIONE
CHOOSE CASE OR FRAME ACCORDING TO THE TYPE OF INSTALLATION

CARTONGESSO/PLASTERBOARD **LATERIZIO/BRICKWALL** **LATERIZIO E CALCESTRUZZO / BRICKWALL & CONCRETE** **LED** **LED**

LED	W	mA	ømm	Hmm	Kg	Im product/beam 3000K	CODE
8	250	55	70	0,28	860	860	LTN89K.9 ○ ● / ##
12	350	55	70	0,28	1285	1285	

Nota: disponibile solo abbinato alla versione GU10 | Note: For version GU10 combine only.

2 SCEGLIERE IL GRUPPO OTTICO / CHOOSE OPTIC GROUP

LED	W	mA	ømm	Hmm	Kg	Im product/beam 3000K	CODE
12	350	55	90	0,30	1285	1285	LTN50K.9 ● ● / ##
18	500	55	90	0,30	1575	1575	

Accessori - accessories: L050#: lente Ø 50
Nota: Alla versione GU10 è possibile abbinare soltanto la lente L###R nido d'ape | Note: For version GU10 combine L###R honey comb only.

GU10

LED **LED**

LED	W	mA	ømm	Hmm	Kg	Im product/beam 3000K	CODE
50	50	55	94	0,21			LTN56K / ##

Accessori - accessories: L050#: lente Ø 50
Nota: Alla versione GU10 è possibile abbinare soltanto la lente L###R nido d'ape | Note: For version GU10 combine L###R honey comb only.

NYX T80F

1 SCEGLIERE CASSA O TELAIO IN BASE AL TIPO DI INSTALLAZIONE
CHOOSE CASE OR FRAME ACCORDING TO THE TYPE OF INSTALLATION

CARTONGESSO/PLASTERBOARD **LATERIZIO/BRICKWALL** **LED** **LED**

LED	W	mA	ø	H	Kg	Im product/beam 3000K	CODE
17	500	90	136	0,80	1930	1827	LTN20K.9 ● ● / ##
24,3	700	90	136	0,80	2468	2356	

Accessori - accessories: L074#: lente Ø 74 - satin Ø 74 Gli apparecchi con temperatura colore Tunable white devono essere associati a driver a 2 canali. | The devices with Tunable white color temperature have to be supplied with 2 channel driver.

NYX T111F

1 SCEGLIERE CASSA O TELAIO IN BASE AL TIPO DI INSTALLAZIONE
CHOOSE CASE OR FRAME ACCORDING TO THE TYPE OF INSTALLATION

CARTONGESSO/PLASTERBOARD **LATERIZIO/BRICKWALL** **LED** **LED**

LED	W	mA	ø	H	Kg	Im product/beam 3000K	CODE
24,3	700	120	168	1,43	2468	2356	LTN70K.9 ● ● / ##
32	900	120	168	1,43	3006	2885	

Accessori - accessories: L111#: lente Ø 111 - lens Ø 111

ACCESSORI / ACCESSORIES

LENTI NYX T50 / LENSES NYX T50

	ø	Kg	CODE
LENTE SATINATA / SATINED LENS	50	0,01	L050S / ##
LENTE ELISSOIDALE / ELIPSOID LENS	50	0,01	L050E / ##
LENTE ASIMMETRICA / ASYMMETRIC LENS	50	0,01	L050A / ##
FILTRO NIDO D'APE / HONEY COMB LOUVER	50	0,01	L050R / ##

LENTI NYX T80 / LENSES NYX T80

	ø	Kg	CODE
LENTE SATINATA / SATINED LENS	74	0,01	L080S / ##
LENTE ELISSOIDALE / ELIPSOID LENS	74	0,01	L080E / ##
LENTE ASIMMETRICA / ASYMMETRIC LENS	74	0,01	L080A / ##
FILTRO NIDO D'APE / HONEY COMB LOUVER	74	0,01	L080R / ##

LENTI NYX T111 / LENSES NYX T111

	ø	Kg	CODE
LENTE SATINATA / SATINED LENS	111	0,01	L111S / ##
LENTE ELISSOIDALE / ELIPSOID LENS	111	0,01	L111E / ##
LENTE ASIMMETRICA / ASYMMETRIC LENS	111	0,01	L111A / ##
FILTRO NIDO D'APE / HONEY COMB LOUVER	111	0,01	L111R / ##

VERSIONI DISPONIBILI / AVAILABLE VERSION

- **KELVIN**
 - 27 2700K
 - 30 3000K
 - 35 3500K
 - 40 4000K
 - TW Tunable White Dali
- **FASCIO / BEAM**
 - S Spot
 - F Flood
 - W Wide

/ ## FINITURA | FINISHING

- / 01 bianco | white
- / 02 nero | black
- / 49 bronzo | bronze

/ ## FINITURA PREMIUM | PREMIUM FINISHING

- / 81 oro rosa | rose gold
- / 82 bronzo antico | antique bronze
- / 83 ottone brunito spazzolato | brushed burnished brass

COMPOSIZIONE CODICE: xxx.x ● ● /

HOW TO CREATE THE CODE: F1000.827S / 01

CODE
F1000.8 | ● ● / ## — finishing
base code | kelvin | beam

TW 350 250
500 700 900

DRIVERS VEDI | SEE P.452

83



NYX TD
TONDO ORIENTABILE RASATO
ROUND Adjustable TRIMLESS



DOWNLIGHT

VERSIONI | VERSIONS



FINITURE | FINISHINGS



NYX T35D



1 SCEGLIERE CASSA O TELAIO IN BASE AL TIPO DI INSTALLAZIONE
CHOOSE CASE OR FRAME ACCORDING TO THE TYPE OF INSTALLATION

CARTONGESSO/PLASTERBOARD (CODE LTN04A): Ø 75, 50 mm inner-outer 55-65.

LATERIZIO/BRICKWALL (CODE LTN04B): 120 x 120 mm, Ø 55,5.

2 SCEGLIERE IL GRUPPO OTTICO / CHOOSE OPTIC GROUP

LED	W	mA	Ø	H	Kg	Im product/beam 3000K	CODE
74	5	500	55	74	0,15	S15° F22°	LTN40K.9 ● / ##

● Disponibile solo fascio F | Available only F beam

NYX T50D



1 SCEGLIERE CASSA O TELAIO IN BASE AL TIPO DI INSTALLAZIONE
CHOOSE CASE OR FRAME ACCORDING TO THE TYPE OF INSTALLATION

CARTONGESSO/PLASTERBOARD (CODE LTN05A): Ø 90, 50 mm inner-outer 70-80.

LATERIZIO/BRICKWALL (CODE LTN05B): 250 x 250 mm, Ø 70,5.

LATERIZIO E CALCESTRUZZO BRICKWALL & CONCRETE (CODE LTN15A): 150 x 125 mm, 120 mm depth.

Nota: disponibile solo abbinato alla versione GU10 | Note: For version GU10 combine only.

2 SCEGLIERE IL GRUPPO OTTICO / CHOOSE OPTIC GROUP

LED	W	mA	Ø	H	α	Kg	Im product/beam 3000K	CODE
355° 30°	8	250	70	85	20	0,55	S15° F27° W46°	LTN69K.9 ● / ##
	12	350	70	85	20	0,55	1285 1285 1285	
355° 30°	12	350	70	105	20	0,38	S15° F27° W46°	LTN60K.9 ● / ##
	18	500	70	105	20	0,38	1575 1575 1575	

GU10

W	Ø	H	Kg	CODE
1x max 50	70	80	0,21	LTN66K / ##

Accessori - accessories: L050#: lente Ø 50
Nota: Alla versione GU10 è possibile abbinare soltanto la lente L###R nido d'ape | Note: For version GU10 combine L###R honey comb only.

NYX T80D



1 SCEGLIERE CASSA O TELAIO IN BASE AL TIPO DI INSTALLAZIONE
CHOOSE CASE OR FRAME ACCORDING TO THE TYPE OF INSTALLATION

CARTONGESSO/PLASTERBOARD (CODE LTN08A): Ø 125, 50 mm inner-outer 105-120.

LATERIZIO/BRICKWALL (CODE LTN08B): 250 x 250 mm, Ø 105,5.

2 SCEGLIERE IL GRUPPO OTTICO / CHOOSE OPTIC GROUP

LED	W	mA	Ø	H	α	Kg	Im product/beam 3000K	CODE
355° 30°	17	500	105	127	20	0,9	S15° F24° W38°	LTN25K.9 ● / ##
	24,3	700	105	127	20	0,9	1930 1827 1905	
355° 30°	24,3	700	105	127	20	0,9	S16° F25° W40°	LTN25K.9 ● / ##
	24,3	700	105	127	20	0,9	2468 2356 2430	

Accessori - accessories: L074#: lente Ø 74 - satin Ø 74 Gli apparecchi con temperatura colore Tunable White devono essere associati a driver a 2 canali. | The devices with Tunable white color temperature have to be supplied with 2 channel driver.

NYX T111D



1 SCEGLIERE CASSA O TELAIO IN BASE AL TIPO DI INSTALLAZIONE
CHOOSE CASE OR FRAME ACCORDING TO THE TYPE OF INSTALLATION

CARTONGESSO/PLASTERBOARD (CODE LTN09A): Ø 150, 50 mm inner-outer 132-140.

LATERIZIO/BRICKWALL (CODE LTN09B): 250 x 250 mm, Ø 131.

2 SCEGLIERE IL GRUPPO OTTICO / CHOOSE OPTIC GROUP

LED	W	mA	Ø	H	α	Kg	Im product/beam 3000K	CODE
355° 30°	24,3	700	140	168	0,9	0,9	S16° F25° W40°	LTN80K.9 ● / ##
	32	900	140	168	0,9	0,9	2468 2356 2430	
355° 30°	32	900	140	168	0,9	0,9	S16° F25° W40°	LTN80K.9 ● / ##
	32	900	140	168	0,9	0,9	3006 2885 2955	

Accessori - accessories: L111#: lente Ø 111 - lens Ø 111

NYX T-SPOT 55



CARTONGESSO/PLASTERBOARD

LED	W	mA	Ø	H	α	Kg	Im product/beam 3000K	CODE
355° 30°	12	350	55	155	1285	1289	S16° F25° W40°	LTN90.9 ● / ##
	18	500	55	155	1575	1579		

ACCESSORI / ACCESSORIES

LENTI NYX T50 / LENSES NYX T50				LENTI NYX T80 / LENSES NYX T80				LENTI NYX T111 / LENSES NYX T111			
Ø	Kg	CODE		Ø	Kg	CODE		Ø	Kg	CODE	
55	0,01	L050S / ##		74	0,01	L080S / ##		111	0,01	L111S / ##	
55	0,01	L050E / ##		74	0,01	L080E / ##		111	0,01	L111E / ##	
55	0,01	L050A / ##		74	0,01	L080A / ##		111	0,01	L111A / ##	
55	0,01	L050R / ##		74	0,01	L080R / ##		111	0,01	L111R / ##	

VERSIONI DISPONIBILI / AVAILABLE VERSION

● KELVIN / **○ KELVIN**

27	2700K	27	2700K
30	3000K	30	3000K
35	3500K	35	3500K
40	4000K	40	4000K

TW Tunable White Dali

● FASCIO / BEAM

S	Spot
F	Flood
W	Wide

FINITURA | FINISHING

01	bianco white
02	nero black
49	bronzo bronze

FINITURA PREMIUM / PREMIUM FINISHING

81	oro rosa / rose gold
82	bronzo anticato antique bronze
83	ottone brunito spazzolato brushed burnished brass

COMPOSIZIONE CODICE: xxx.x ● / ##
HOW TO CREATE THE CODE: **F1000.827S / 01**

base code | kelvin | beam

DRIVERS VEDI | P.452

Per i gradi vedere in tabella - For degrees check the table

NYX FRAME

FISSO - FIXED



VERSIONI / VERSIONS



FINITURE / FINISHINGS



VERSIONI DISPONIBILI / AVAILABLE VERSION

- **KELVIN**
- 27 2700K
- 30 3000K
- 35 3500K
- 40 4000K

- **KELVIN**
- 27 2700K
- 30 3000K
- 35 3500K
- 40 4000K

- TW Tunable White Dali
- **FASCIO / BEAM**
- S Spot
- F Flood
- W Wide

FINITURA | FINISHING

- / 01 bianco | white
- / 02 nero | black
- / 36 oro | gold
- / 49 bronzo | bronze

FINITURA PREMIUM / PREMIUM FINISHING

- / 81 oro rosa | rose gold
- / 82 bronzo anticato|antique bronze
- / 83 ottone brunito spazzolato|brushed burnished brass

COMPOSIZIONE CODICE: xxx.x ●● /

HOW TO CREATE THE CODE: **F1000.827S / 01**

CODE
F1000.8 | ● | ● | ## — finishing
 base code kelvin beam

DRIVERS VEDI | SEE P.452

NYX TF35F

CARTONGESSO/PLASTERBOARD

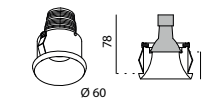

LED		Im product/beam 3000K		CODE		
W	mA	ø	H	F22°	F22°	
5	500	60	78	0,18	520	NF010.9 ●● / ##

● Disponibile solo fascio F | Available only F beam

NYX TF50F

CARTONGESSO/PLASTERBOARD

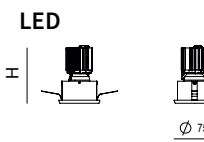

LED		Im product/beam 3000K		CODE		
W	mA	ø	H	F27°	W46°	
8	250	75	102	0,25	860	NF024.9 ●● / ##
12	350	75	102	0,25	1285	

LED		Im product/beam 3000K		CODE		
W	mA	ø	H	F27°	W46°	
12	350	75	122	0,25	1285	NF023.9 ●● / ##
18	500	75	122	0,25	1575	

GU10

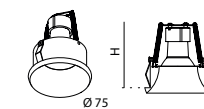

GU10LED		CODE		
W	ø	H	Kg	
1 x max50	75	86	0,25	NF028 / ##

Accessori - accessories: L050#: lente ø 50 - lens ø 50
 Gli apparecchi con temperatura colore Tunable White devono essere associati a driver a 2 canali. | The devices with Tunable white color temperature have to be supplied with 2 channel driver.

NYX TF80F

PER CARTONGESSO/ FOR PLASTERBOARD

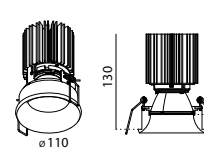

LED		Im product/beam 3000K		CODE		
W	mA	ø	H	S15°	F24°	
17	500	110	130	0,85	1930	NF040.9 ●● / ##
24,3	700	110	130	0,85	2468	
					2356	2430

Accessori - accessories: L074#: lente ø 74 - lens ø 74
 Gli apparecchi con temperatura colore Tunable White devono essere associati a driver a 2 canali. | The devices with Tunable white color temperature have to be supplied with 2 channel driver.

NYX TF111F

PER CARTONGESSO/ FOR PLASTERBOARD

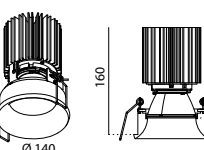

LED		Im product/beam 3000K		CODE		
W	mA	ø	H	S16°	F25°	
24,3	700	140	160	1,4	2468	NF060.9 ●● / ##
32	900	140	160	1,4	3006	
					2885	2955

Accessori - accessories: L111#: lente ø 111 - lens ø 111

ACCESSORI / ACCESSORIES

LENTI NYX T50 / LENSES NYX T50

	ø	Kg	CODE
LENTE SATINATA/SATINED LENS	50	0,01	L050S / ##
LENTE ELISSOIDALE/ELIPSOID LENS	50	0,01	L050E / ##
LENTE ASIMMETRICA/ASYMMETRIC LENS	50	0,01	L050A / ##
FILTRO NIDO D'APE/ HONEY COMB LOUVER	50	0,01	L050R / ##

LENTI NYX T80 / LENSES NYX T80

	ø	Kg	CODE
LENTE SATINATA/SATINED LENS	74	0,01	L080S / ##
LENTE ELISSOIDALE/ELIPSOID LENS	74	0,01	L080E / ##
LENTE ASIMMETRICA/ASYMMETRIC LENS	74	0,01	L080A / ##
FILTRO NIDO D'APE/ HONEY COMB LOUVER	74	0,01	L080R / ##

LENTI NYX T111 / LENSES NYX T111

	ø	Kg	CODE
LENTE SATINATA/SATINED LENS	111	0,01	L111S / ##
LENTE ELISSOIDALE/ELIPSOID LENS	111	0,01	L111E / ##
LENTE ASIMMETRICA/ASYMMETRIC LENS	111	0,01	L111A / ##
FILTRO NIDO D'APE/ HONEY COMB LOUVER	111	0,01	L111R / ##

NYX FRAME

ORIENTABILE - ADJUSTABLE

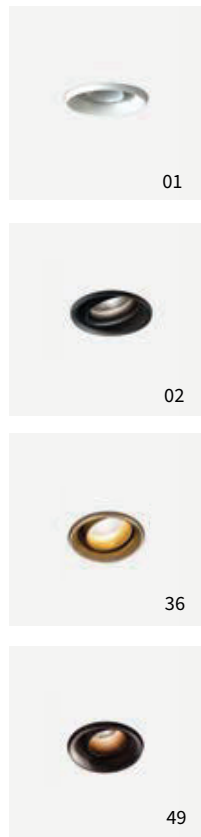
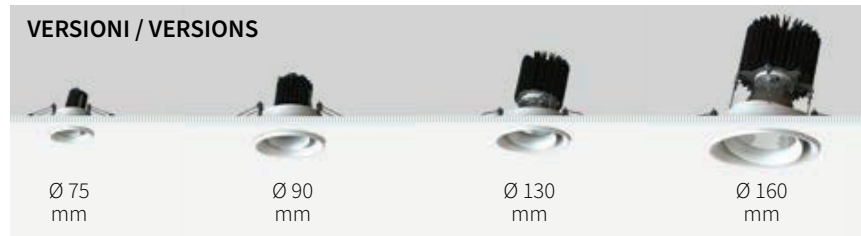

VERSIONI DISPONIBILI / AVAILABLE VERSION

- **KELVIN**
- 27 2700K
- 30 3000K
- 35 3500K
- 40 4000K
- TW Tunable White Dali

- **FASCIO / BEAM**
- S Spot
- F Flood
- W Wide

FINITURA | FINISHING

- / 01 bianco | white
- / 02 nero | black
- / 36 oro | gold
- / 49 bronzo | bronze

FINITURA PREMIUM / PREMIUM FINISHING

- / 81 oro rosa | rose gold
- / 82 bronzo antico | antique bronze
- / 83 ottone brunito spazzolato | brushed burnished brass

COMPOSIZIONE CODICE: xxx.x ●● /

HOW TO CREATE THE CODE: **F1000.827S / 01**



DRIVERS VEDI | SEE P.452

90 Per i gradi vedere in tabella - For degrees check the table

NYX TF35D

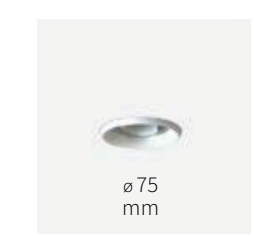

CARTONGESSO/PLASTERBOARD

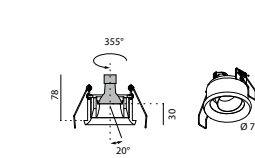

LED		Im product / beam 3000K		CODE					
W	mA	ø	H	α	Kg	F22°	W46°		
5	500	75	78	20	0,28	520			NF015.9 ●● / ##

● Disponibile solo fascio F | Available only F beam



NYX TF50D



CARTONGESSO/PLASTERBOARD

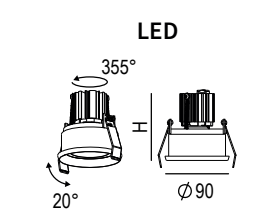

LED		Im product / beam 3000K		CODE					
W	mA	ø	H	α	Kg	F27°	W46°		
8	250	90	94	20	0,35	860	860		NF031.9 ●● / ##
12	350	90	94	20	0,35	1285	1285		

LED		Im product / beam 3000K		CODE					
W	mA	ø	H	α	Kg	F27°	W46°		
12	350	90	114	20	0,35	1285	1289		NF033.9 ●● / ##
18	500	90	114	20	0,35	1575	1579		

Gli apparecchi con temperatura colore Tunable White devono essere associati a driver a 2 canali. | The devices with Tunable white color temperature have to be supplied with 2 channel driver.

GU10 LED		CODE		
W	ø	H	α	Kg
50	90	84	20	0,32

NF038 / ##

Accessori - accessories: L050#: lente ø 50 - lens ø 50
Nota: Alla versione GU10 è possibile abbinare soltanto la lente L##R nido d'ape | Note: For version GU10 combine L##R honey comb only.

NYX TF80D



CARTONGESSO/PLASTERBOARD

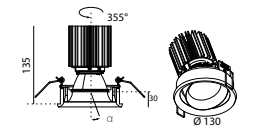

LED		Im product / beam 3000K		CODE					
W	mA	ø	H	α	Kg	S15°	F24°	W38°	
17	500	130	135	20	1	1546	1645	1730	NF050.9 ●● / ##
24,3	700	130	135	20	1	2045	2160	2250	

Accessori - accessories: L074#: lente ø 74 - lens ø 74 Gli apparecchi con temperatura colore Tunable White devono essere associati a driver a 2 canali. | The devices with Tunable white color temperature have to be supplied with 2 channel driver.

NYX TF111D



CARTONGESSO/PLASTERBOARD

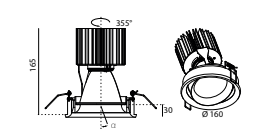

LED		Im product / beam 3000K		CODE					
W	mA	ø	H	α	Kg	S15°	F24°	W38°	
24,3	700	160	165	20	1,65	2468	2356	2430	NF070.9 ●● / ##
32	900	160	165	20	1,65	3006	2885	2955	

Accessori - accessories: L111#: lente ø 111 - lens ø 111

ACCESSORI / ACCESSORIES

LENTI NYX Q50 / LENSES NYX Q50				LENTI NYX Q80 / LENSES NYX Q80				LENTI NYX Q111 / LENSES NYX Q111			
ø	Kg	CODE		ø	Kg	CODE		ø	Kg	CODE	
50	0,01	L050S / ##		74	0,01	L080S / ##		111	0,01	L111S / ##	
50	0,01	L050E / ##		74	0,01	L080E / ##		111	0,01	L111E / ##	
50	0,01	L050A / ##		74	0,01	L080A / ##		111	0,01	L111A / ##	
50	0,01	L050R / ##		74	0,01	L080R / ##		111	0,01	L111R / ##	



Apparecchio da incasso trimless per installazioni in controsoffitto in cartongesso con sorgente luminosa in posizione arretrata antiabbagliamento UGR<19. Provvisto di cilindro estraibile dalla sede di incasso fino a 6 o 10 cm., a seconda del modello. Con sorgente LED Chip On Board integrata o per lampade alogene / led GU10 230V / 240V. Corpo e gruppo ottico in alluminio verniciato. Alimentazione remota disponibile come accessorio. Grado di protezione IP54.

Trimless recessed luminaire for plasterboard ceiling installations with light source in the anti-glare recessed position UGR <19. Provided with a cylinder that can be extracted from the built-in seat up to 6 or 10 cm, depending on the model. Integrated Chip On Board LED source or for halogen / led lamps GU10 230V / 240V. Body and optical group in painted aluminum. Remote power supply available as an accessory. IP54.

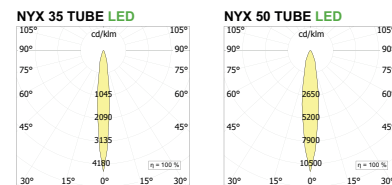

NYX TUBE 35

CARTONGESSO/PLASTERBOARD

8-30 IP54 Ø 40 Ø 65

IP20 IP54 CRI >90 5 UBA CE 500

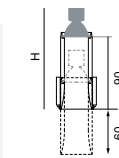

LED W mA Ø H lm product/beam 3000K F22° CODE LTN30T.9 ●● / ##

● Disponibile solo fascio F | Available only F beam

QR:CB35 GU4 12V

W mA Ø H CODE LTN34T / ##

NYX TUBE 50

CARTONGESSO/PLASTERBOARD

8-30 IP54 Ø 55 Ø 75

IP20 IP54 CRI >90 5 UBA CE 250 350

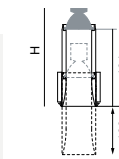

LED W mA Ø H lm product/beam 3000K S17° CODE LTN69T.9 ●● / ##

8 250 90 112/212 860

12 350 90 112/212 1285

LED W mA A Ø H lm product/beam 3000K S17° CODE LTN50T.9 ●● / ##

12 350 55 132 / 232 550

18 500 55 132 / 232 657

Gli apparecchi con temperatura colore Tunable White devono essere associati a driver a 2 canali. | The devices with Tunable white color temperature have to be supplied with 2 channel driver.

GU10 LED

W mA Ø H CODE LTN56T / ##

50 55 98 / 198

VERSIONI DISPONIBILI / AVAILABLE VERSION

- KELVIN
- 27 2700K
- 30 3000K
- 35 3500K
- 40 4000K
- TW Tunable White Dali

- FASCIO / BEAM
- S Flood
- F Flood

/ ## FINITURA | FINISHING

- / 01 bianco | white
- / 02 nero | black
- / 49 bronzo | bronze

/ ## FINITURA PREMIUM / PREMIUM FINISHING

- / 81 oro rosa / rose gold
- / 82 bronzo anticato|antique bronze
- / 83 ottone brunito spazzolato|brushed burnished brass

COMPOSIZIONE CODICE: xxx.x ●● /

HOW TO CREATE THE CODE: F1000.827S / 01

CODE
F1000.8 | ●● / ## — finishing
base code kelvin beam

TW 700 350 500
DRIVERS VEDI | SEE P.452

Per i gradi vedere in tabella - For degrees check the table



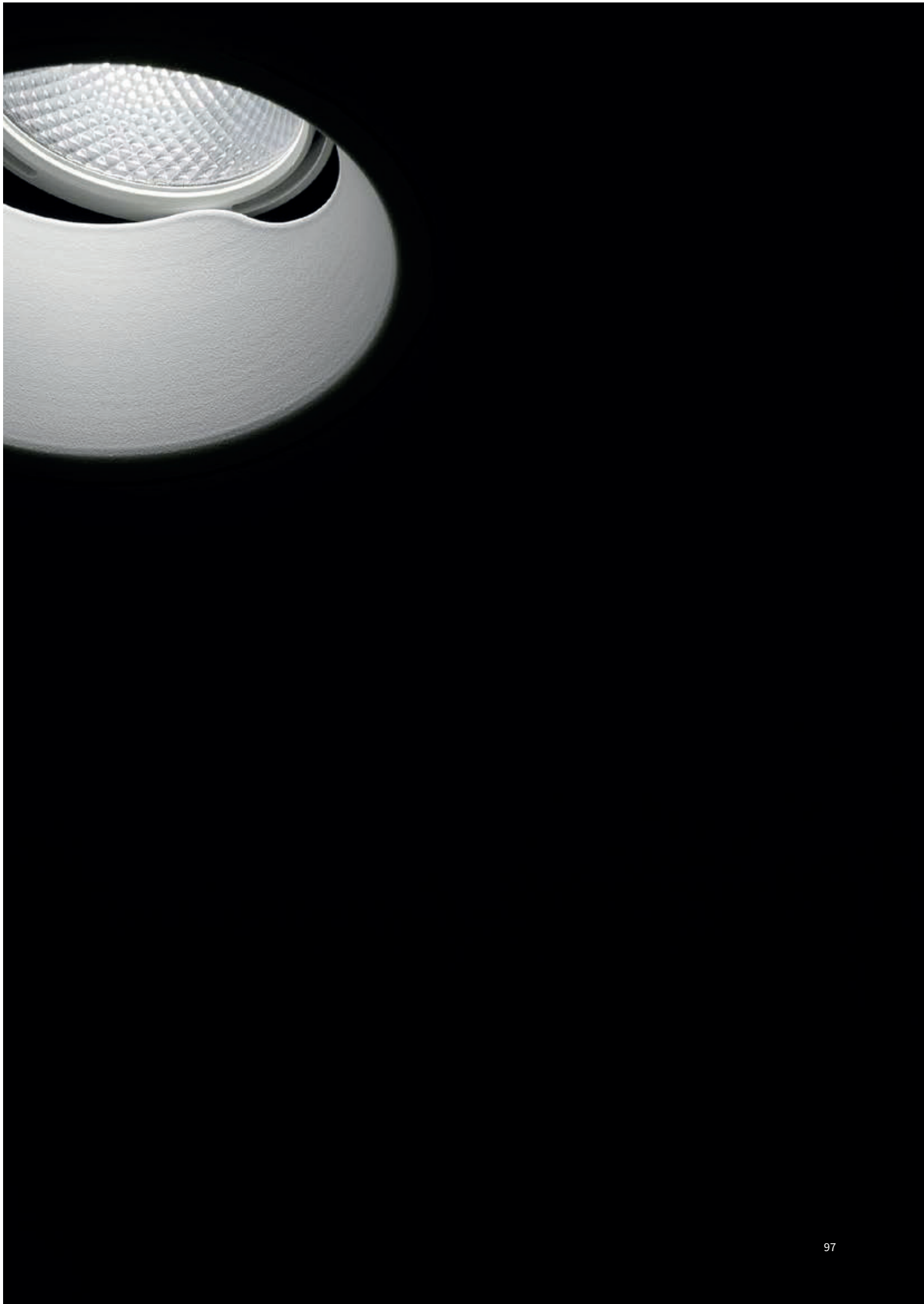

TWENTY 7

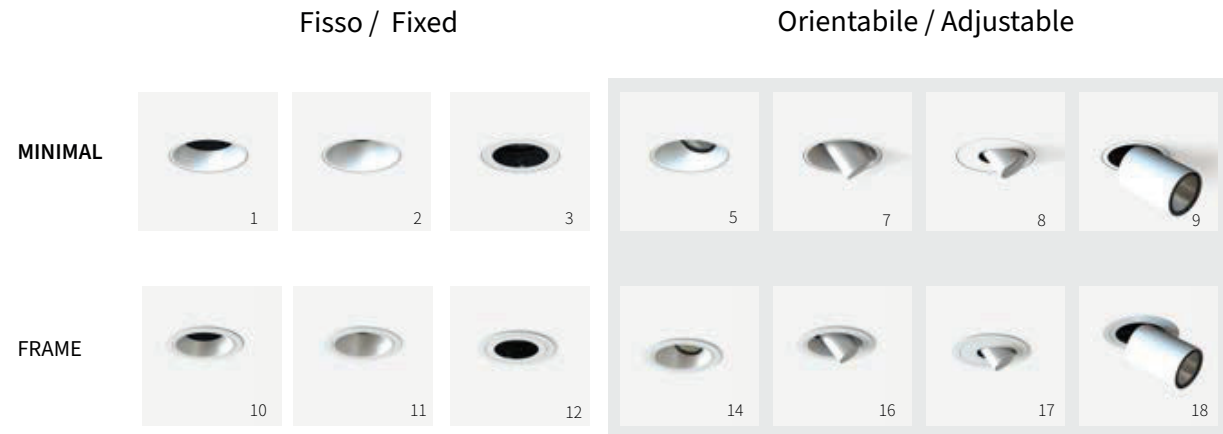

Famiglia di apparecchi da incasso e proiettori da incasso a soffitto per sorgenti LED Chip On Board integrate. Studiati per ottenere, mediante la semplice aggiunta di accessori al corpo lampada, 14 diverse soluzioni illuminotecniche, come varianti delle seguenti emissioni base: diffusa, spot, bassa luminanza e asimmetrica. Disponibili sia in versione rotonda per incasso trimless oppure rotonda con cornice. Disponibilità di molteplici varianti, basculanti con meccanismo roto-traslante oppure con corpo estraibile. Corpo lampada e gruppo ottico in alluminio verniciato, riflettore metallizzato in alluminio 99,99%. Cover coniche in alluminio, per emissioni a bassa luminanza, diffuse o asimmetriche, provviste di sistema di fissaggio e sgancio dal gruppo ottico, mediante calamite, Click and Play. Filtri ottici, satinati, Fresnel e microprismatici (UGR<19) in policarbonato. Griglia a nido d'ape antiabbagliamento in alluminio verniciato. Cover di chiusura inferiori in alluminio verniciato, con foro ellittico, quadrato e tondo, per nascondere l'emissione luminosa. Grado di protezione IP23 / IP43.

Family of recessed luminaires and recessed ceiling projectors for integrated Chip On Board LED sources. Designed to obtain, by simply adding accessories to the lamp body, 14 different lighting solutions, as variants of the following basic emissions: diffuse, spot, low luminance and asymmetric. Available both in round trimless recessed version, or round and square framed. Multiple variants available, tilting with roto-translating mechanism or with extractable body. Body and optical group in painted aluminum, metallized reflector in 99.99% aluminum. Conical aluminum covers, for low luminance emissions, diffused or asymmetrical, equipped with fixing and release system from the optical unit, using magnets, Click and Play. Optical filters, satinated, Fresnel and microprismatic (UGR<19) in polycarbonate. Anti-glare honeycomb grid in painted aluminum. Closing covers in painted aluminum, with elliptical, square and round hole, to hide the light emission. IP23 / IP43.

FINITURE / FINISHINGS



01-BIANCO / WHITE



02-NERO / BLACK

FINITURE PREMIUM / PREMIUM FINISHINGS



81-ORO ROSA / PINK GOLD



82- BRONZO ANTICATO/ ANTIQUE BRONZE



83 - OTTONE BRUNITO SPAZZOLATO/BRUSHED BURNISHED BRASS



1



2



81



82



83



UK CONFORMITY ASSESSMENT E EUROPEAN CERTIFICATION / UK CONFORMITY ASSESSMENT AND EUROPEAN CERTIFICATION



PRODOTTI COSTRUITI CON MATERIALE RECICLABILE / PRODUCTS MADE OF RECYCLABLE MATERIAL



GARANZIA DI 5 ANNI / 5-YEAR WARRANTY



FISSO / FIXED



ORIENTABILE / ADJUSTABLE

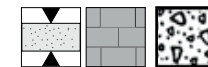

IDONEI PER CARTONGESSO OR LATERIZIO / CALCESTRUZZO a seconda dei modelli e degli accessori. SUITABLE FOR PLASTERBOARD OR BRICKWALL / CONCRETE it depends on the model and its accessories.



Possibilità di montare lampade adatte alla crescita delle piante indoor / Horticulture version suitable for growth indoor. L'illuminazione adatta al verde converte l'energia elettrica in fotoni che stimolano la fotosintesi delle piante anche in assenza di luce naturale.

EASY RE-FITTING

Twenty7 è provvisto di sistema Click&Play di fissaggio e sgancio delle cover al gruppo ottico mediante calamite.

Twenty7 is provided with Click&Play magnetic lock-unlock system of the cover to optical group.

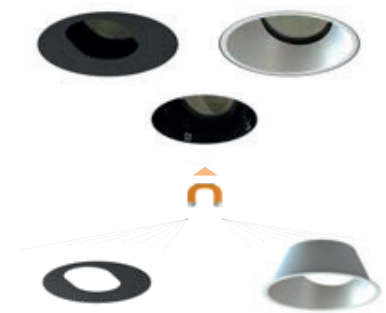

KELVIN

27	2700°K
30	3000°K
35	3500°K
40	4000°K
HC	HORTICULTURE
TW	TUNABLE WHITE*

FASCIO / BEAM

S	SPOT
F	FLOOD
W	WIDE

* Tunable White 2700 – 5000°K

La tecnologia Tunable White consente di controllare la temperatura di colore delle sorgenti luminose permettendo di scegliere quella più adatta tra luce bianca calda e fredda. / Tunable White technology allows you to control the color temperature of light sources allowing you to choose the most suitable between warm and cold white light.

CURVE FOTOMETRICHE / PHOTOMETRIC DATA

TWENTY COVER CONICA

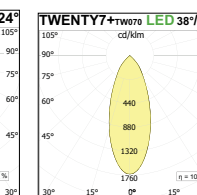
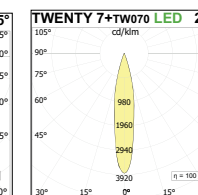
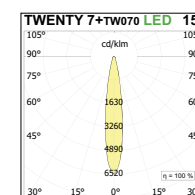

TWENTY FOCUS 55

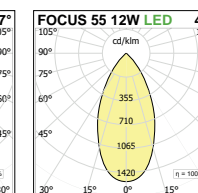
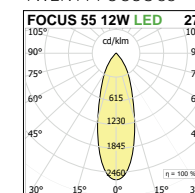

TWENTY FOCUS 90

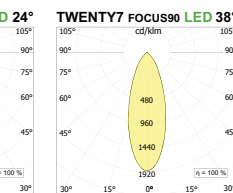
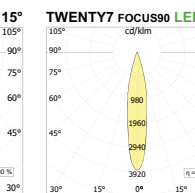
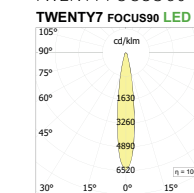

TWENTY7 MINIMAL

TELAIO OBBLIGATORIO MANDATORY RING

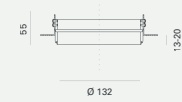

Dim.	H	Kg	CODE
Ø132	55	0,17	TW001

1 FISSO MINIMAL-COVER CONICA BASSA MINIMAL FIXED- LOW CONICAL COVER

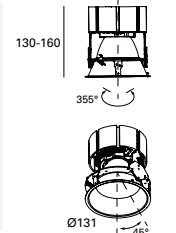

LED W	mA	Ø	H	Im product/beam 3000K	W41°	CODE
17	500	131	130	1415		TW100.9 ● ● / ##
24,3	700	131	130	1854		
32	900	131	160	3645		TW101.9 ● ● / ##

● disponibile solo fascio W available only W beam
Accessori - accessories: TW001: telaio minimal OBBLIGATORIO - Accessories minimal ring mandatory
L105#: lente Ø 105 - lens Ø 105

2 FISSO MINIMAL-COVER CONICA ALTA MINIMAL FIXED-HIGH CONICAL COVER

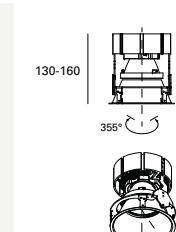

LED W	mA	Ø	H	Im product/beam 3000K	S15°	F24°	W38°	CODE
17	500	131	130	1930	1827	1905		TW102.9 ● ● / ##
24,3	700	131	130	2468	2356	2430		
32	900	131	160	3006	2885	2955		TW103.9 ● ● / ##

Accessori - accessories: TW001: telaio minimal OBBLIGATORIO - minimal ring COMPULSORY
L85#: lente Ø 85 - lens Ø 85 Gli apparecchi con temperatura colore Tunable White devono essere associati a driver a 2 canali. | The devices with Tunable white color temperature have to be supplied with 2 channel driver.

3 FISSO MINIMAL-COVER PIANA TONDA MINIMAL FIXED-ROUND FLAT COVER

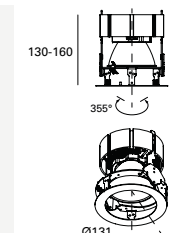

LED W	mA	Ø	H	Im product/beam 3000K	S15°	F21°	CODE
17	500	131	130	1080	1185		TW104.9 ● ● / ##
24,3	700	131	130	1404	1452		
32	900	131	160	2113	2326		TW105.9 ● ● / ##

Accessori - accessories: TW001: telaio minimal OBBLIGATORIO - minimal ring COMPULSORY
L105#: lente Ø 105 - lens Ø 105 Gli apparecchi con temperatura colore Tunable White devono essere associati a driver a 2 canali. | The devices with Tunable white color temperature have to be supplied with 2 channel driver.

5 ORIENTABILE MINIMAL-COVER CONICA ELLITTICA 5 MINIMAL ADJUSTABLE-CONICAL-ELLIPTICAL COVER

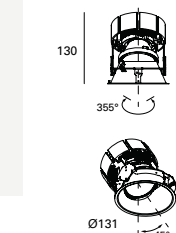

LED W	mA	Ø	H	Im product/beam 3000K	S15°	F24°	W41°	CODE
17	500	131	130	1080	1212	1697		TW112.9 ● ● / ##
24,3	700	131	130	1404	1626	2233		
32	900	131	160	3620	2326	3645		TW113.9 ● ● / ##

● Disponibile anche HC Horticulture Available HC Horticulture version
Accessori - accessories: TW001: telaio minimal OBBLIGATORIO - minimal ring COMPULSORY
L85#: lente Ø 85 - lens Ø 85. Gli apparecchi con temperatura colore Tunable White devono essere associati a driver a 2 canali. | The devices with Tunable white color temperature have to be supplied with 2 channel driver.

7 ORIENTABILE MINIMAL-COVER CONICA + FOCUS 55 7 MINIMAL ADJUSTABLE-FOCUS 55 CONICAL COVER

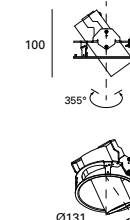

LED W	mA	Ø	H	Im product/beam 3000K	S15°	F27°	W46°	CODE
12	350	131	100	1285	1285	1289		TW115.9 ● ● / ##
18	500	131	100	1575	1575	1579		

Accessori - accessories:
TW001: telaio minimal OBBLIGATORIO - minimal ring COMPULSORY - L55#: lente Ø 55 - lens Ø 55
Gli apparecchi con temperatura colore Tunable White devono essere associati a driver a 2 canali. | The devices with Tunable white color temperature have to be supplied with 2 channel driver.

8 ORIENTABILE MINIMAL-COVER PIANA ELLITTICA+ FOCUS 55 8 MINIMAL ADJUSTABLE-FOCUS 55 FLAT-ELLIPTICAL COVER

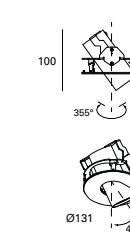

LED W	mA	Ø	H	Im product/beam 3000K	S15°	F27°	W46°	CODE
12	350	131	100	1285	1285	1289		TW114.9 ● ● / ##
18	500	131	100	1575	1575	1579		

Accessori - accessories:
TW001: telaio minimal OBBLIGATORIO - minimal ring COMPULSORY - L55#: lente Ø 55 - lens Ø 55.
Gli apparecchi con temperatura colore Tunable White devono essere associati a driver a 2 canali. | The devices with Tunable white color temperature have to be supplied with 2 channel driver.

9 ORIENTABILE MINIMAL-FOCUS 90 MINIMAL ADJUSTABLE-FOCUS 90

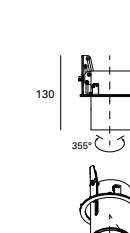

LED W	mA	Ø	H	Im product/beam 3000K	S15°	F24°	W38°	CODE
17	500	131	130	1930	1827	1905		TW116.9 ● ● / ##
24,3	700	131	130	2468	2356	2430		
32	900	131	130	3006	2885	2955		TW117.9 ● ● / ##

● Disponibile anche HC Horticulture Available HC Horticulture version

Accessori - accessories:
TW001: telaio minimal OBBLIGATORIO - minimal ring COMPULSORY - L85#: lente Ø 85 - lens Ø 85. Gli apparecchi con temperatura colore Tunable White devono essere associati a driver a 2 canali. | The devices with Tunable white color temperature have to be supplied with 2 channel driver.

ACCESSORI / ACCESSORIES

LENTI 55 / LENSES 55

	Ø	Kg	CODE
LENTE SATINATA / SATINED LENS	55	0,01	L055.A / ##
LENTE ELISSOIDALE / ELIPSOID LENS	55	0,01	L055.E.A / ##
LENTE ASIMMETRICA / ASYMMETRIC LENS	55	0,01	L055.A.A / ##
FILTRO NIDO D'APIE / HONEY COMB LOUVER	55	0,01	L055.R.A / ##

LENTI 85 / LENSES NYX 85

	Ø	Kg	CODE
	85	0,01	L085.S.A / ##
	85	0,01	L085.E.A / ##
	85	0,01	L085.A.A / ##
	85	0,01	L085.R.A / ##

LENTI 115 / LENSES NYX 115

	Ø	Kg	CODE
	115	0,01	L0115.S.A / ##
	115	0,01	L0115.E.A / ##
	115	0,01	L0115.A.A / ##
	115	0,01	L0115.R.A / ##

VERSIONI DISPONIBILI / AVAILABLE VERSION

- **KELVIN**
- 27 2700K
- 30 3000K
- 35 3500K
- 40 4000K
- HC Horticulture
- TW Tunable White Dali
- **FASCIO / BEAM**
- S Spot
- F Flood
- W Wide

/ ## FINITURA | FINISHING

- / 01 bianco | white
- / 02 nero | black
- / 49 bronzo | bronze

/ ## FINITURA PREMIUM | PREMIUM FINISHING

- / 81 oro rosa | rose gold
- / 82 bronzo antico | antique bronze
- / 83 ottone brunito spazzolato | brushed burnished brass

COMPOSIZIONE CODICE: xxx.x ● ● /

HOW TO CREATE THE CODE: **F1000.827S/01**

CODE
F1000.8 | ● | ● | / ## — finishing
base code kelvin beam

350 500 700 900 TW

DRIVERS VEDI | SEE P.452

TWENTY7 ROUND FRAME

10 TONDA FISSO-COVER CONICA BASSA ROUND FIXED-LOW CONICAL COVER

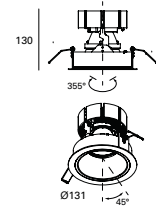

LED W	mA	ømm	H	lm product/beam 3000K	W41°	CODE
17	500	131	130	1415		TW210.9 ○ W / ##
24,3	700	131	130	1854		

LED W	mA	ømm	H	lm product/beam 3000K	W41°	CODE
32	900	131	160	3645		TW211.9 ○ W / ##

● disponibile solo fascio W available only W beam
Accessori - accessories: L105#: lente Ø 105 - lens Ø 105

11 TONDA FISSO-COVER CONICA ALTA ROUND FIXED-HIGH CONICAL COVER

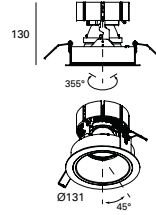

LED W	mA	ømm	H	lm product/beam 3000K	S15°	F24°	W38°	CODE
17	500	131	130	1930	1827	1905		TW212.9 ● ● / ##
24,3	700	131	130	2468	2356	2430		

LED W	mA	ømm	H	lm product/beam 3000K	S15°	F24°	W38°	CODE
32	900	131	160	3006	2885	2955		TW213.9 ● ● / ##

Accessori - accessories: L85#: lente Ø 85 - lens Ø 85 Gli apparecchi con temperatura colore Tunable White devono essere associati a driver a 2 canali. | The devices with Tunable white color temperature have to be supplied with 2 channel driver.

12 TONDA FISSO-COVER PIANA TONDA ROUND FIXED-ROUND FLAT COVER

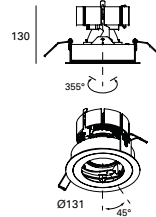

LED W	mA	ømm	H	lm product/beam 3000K	S15°	F21°	CODE
17	500	131	130	1080	1185		TW214.9 ● ● / ##
24,3	700	131	130	1404	1452		

LED W	mA	ømm	H	lm product/beam 3000K	S15°	F21°	CODE
32	900	131	160	2113	2326		TW215.9 ● ● / ##

● disponibile solo fascio S e F available only S and F beam

Accessori - accessories: L85#: lente Ø 85 - lens Ø 85 Gli apparecchi con temperatura colore Tunable White devono essere associati a driver a 2 canali. | The devices with Tunable white color temperature have to be supplied with 2 channel driver.

14 TONDA ORIENTABILE-COVER CONICA ELLITTICA 14 ROUND ADJUSTABLE-CONICAL-ELLIPTICAL COVER

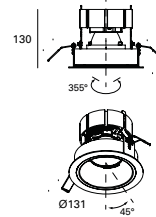

LED W	mA	ømm	H	lm product/beam 3000K	S15°	F24°	W38°	CODE
17	500	131	130	1930	1827	1905		TW220.9 ● ● / ##
24,3	700	131	130	2468	2356	2430		

LED W	mA	ømm	H	lm product/beam 3000K	S15°	F24°	W38°	CODE
32	900	131	160	3006	2885	2955		TW221.9 ● ● / ##

● Disponibile anche HC Horticulture Available HC Horticulture version

Accessori - accessories: L85#: lente Ø 85 - lens Ø 85 Gli apparecchi con temperatura colore Tunable White devono essere associati a driver a 2 canali. | The devices with Tunable white color temperature have to be supplied with 2 channel driver.

16 TONDA ORIENTABILE-COVER CONICA + FOCUS 55 16 ROUND ADJUSTABLE-FOCUS 55 CONICAL COVER

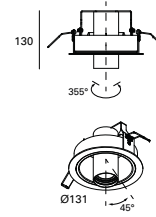

LED W	mA	ømm	H	lm product/beam 3000K	S15°	F27°	W46°	CODE
12	350	131	130	1285	1285	1289		TW224.9 ● ● / ##
18	500	131	130	1575	1575	1579		

Accessori - accessories: L55#: lente Ø 55 - lens Ø 55 Gli apparecchi con temperatura colore Tunable White devono essere associati a driver a 2 canali. | The devices with Tunable white color temperature have to be supplied with 2 channel driver.

17 TONDA ORIENTABILE-COVER PIANA + FOCUS 55 ROUND ADJUSTABLE-FOCUS 55 FLAT COVER

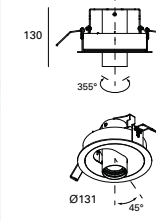

LED W	mA	ømm	H	lm product/beam 3000K	S15°	F27°	W46°	CODE
12	350	131	130	1285	1285	1289		TW225.9
18	500	164	130	1575	1575	1579		

Accessori - accessories: L55#: lente Ø 55 - lens Ø 55 Gli apparecchi con temperatura colore Tunable White devono essere associati a driver a 2 canali. | The devices with Tunable white color temperature have to be supplied with 2 channel driver.

18 TONDA ORIENTABILE-FOCUS 90 ROUND ADJUSTABLE-FOCUS 90

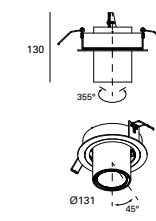

LED W	mA	ømm	H	lm product/beam 3000K	S15°	F24°	W38°	CODE
17	500	131	130	1930	1827	1905		TW226.9
24,3	700	131	130	2468	2356	2430		

LED W	mA	ømm	H	lm product/beam 3000K	S15°	F24°	W38°	CODE
32	900	131	130	3006	2885	2955		TW227.9

● Disponibile anche HC Horticulture Available HC Horticulture version

Accessori - accessories: L85#: lente Ø 85 - lens Ø 85 Gli apparecchi con temperatura colore Tunable White devono essere associati a driver a 2 canali. | The devices with Tunable white color temperature have to be supplied with 2 channel driver.

ACCESSORI / ACCESSORIES

LENTI NYX 55 / LENSES NYX 55				LENTI NYX 85 / LENSES NYX 85			LENTI NYX 115 / LENSES NYX 115		
Ø	Kg	CODE		Ø	Kg	CODE	Ø	Kg	CODE
55	0,01	L055S.A / ##		85	0,01	L085S.A / ##	115	0,01	L0115S.A / ##
55	0,01	L055E.A / ##		85	0,01	L085E.A / ##	115	0,01	L0115E.A / ##
55	0,01	L055A.A / ##		85	0,01	L085A.A / ##	115	0,01	L0115A.A / ##
55	0,01	L055R.A / ##		85	0,01	L085R.A / ##	115	0,01	L0115R.A / ##

VERSIONI DISPONIBILI / AVAILABLE VERSION

KELVIN		KELVIN		FINITURA / FINISHING		COMPOSIZIONE CODICE: xxx.x ● ● / ##	
27	2700K	27	2700K	01	bianco white	HOW TO CREATE THE CODE: F1000.827S / 01	
30	3000K	30	3000K	02	nero black	CODE	
35	3500K	35	3500K	49	bronzo bronze	F1000.8	
40	4000K	40	4000K	##	FINITURA PREMIUM / PREMIUM FINISHING	base code kelvin beam	
TW	Tunable White Dali	81	oro rosa rose gold	##	FINITURA PREMIUM / PREMIUM FINISHING	DRIVERS VEDI SEE P.452	
S	Spot	82	bronzo antico antique bronze	##	FINITURA PREMIUM / PREMIUM FINISHING		
F	Flood	83	ottone brunito spazzolato brushed burnished brass	##	FINITURA PREMIUM / PREMIUM FINISHING		
W	Wide						

Per i gradi vedere in tabella - For degrees check the table



LEVA & LEVA QUADRA

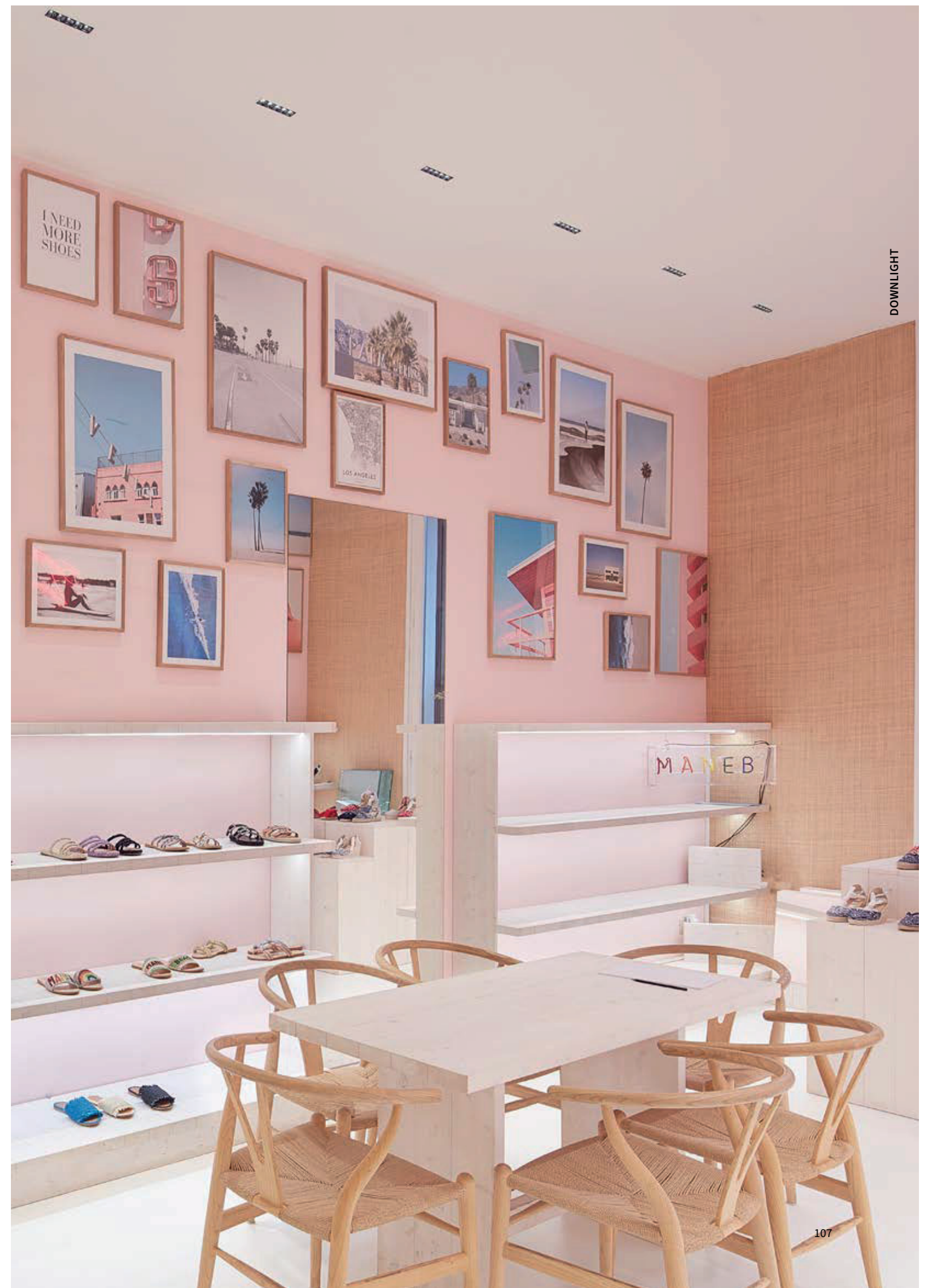
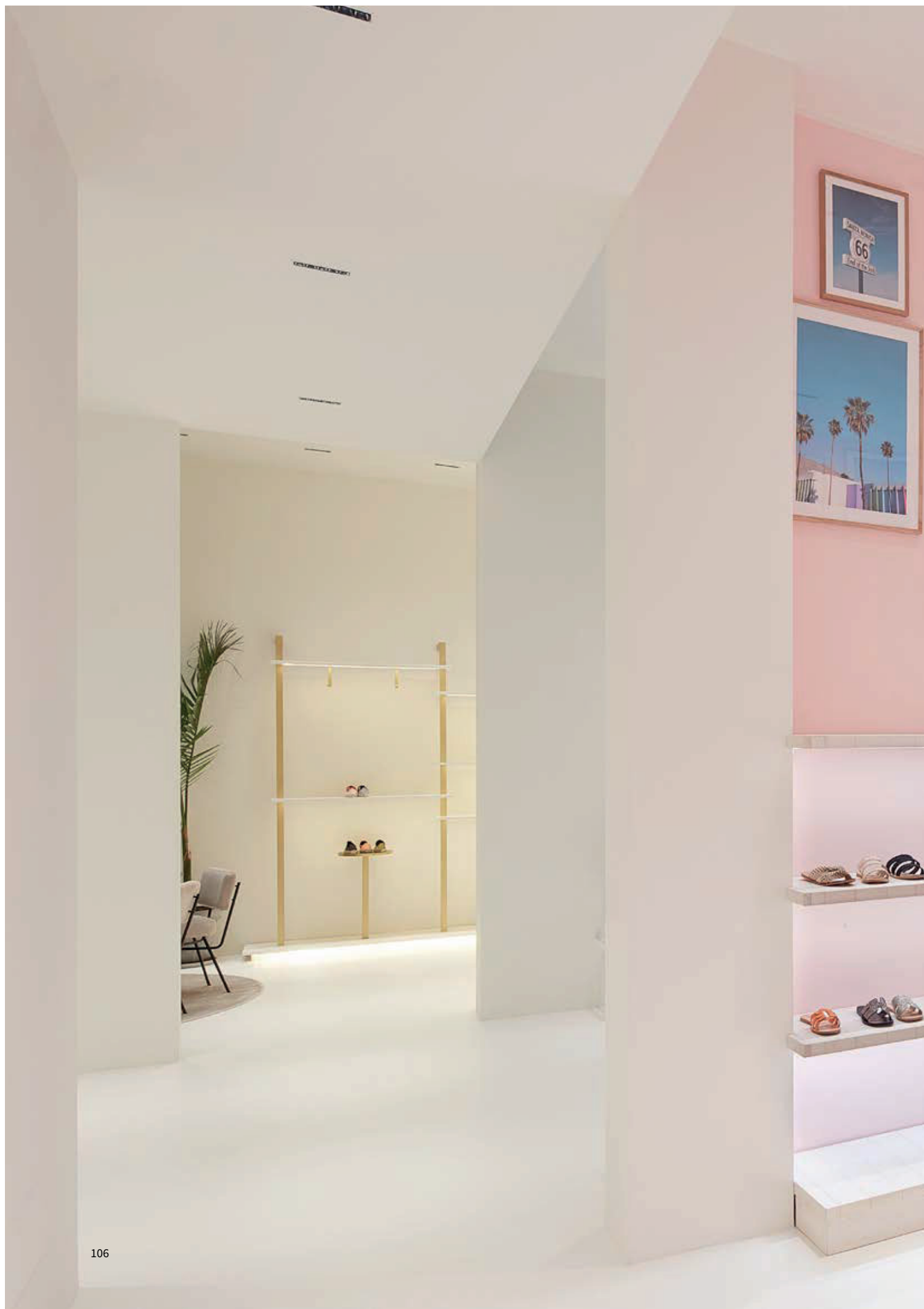

LEVA & LEVA QUADRA

Collezione di apparecchi da incasso, fissi ed orientabili, con sorgenti LED Chip On Board integrate. Possibilità di montaggio trimless o con battuta. Corpo apparecchio in estruso di alluminio verniciato. Gruppi ottici antiabbagliamento completi di led chip on board (CRI>90) e lenti. Ottiche spot, flood, wideflood ed ellittiche UGR<16. Da completare con alimentatori elettronici remoti. Grado di protezione IP20 / IP43.

Recessed luminaires, fixed and adjustable, trimless or trimmed with integrated Chip On Board LED sources. Extruded aluminum painted body. Anti-glare optical groups complete with LED chip on board (CRI> 90) and lenses. Spot, flood, wideflood and elliptical optics UGR <16. To be completed with remote electronic drivers. IP20 / IP43.



UK CONFORMITY ASSESSMENT E EUROPEAN CERTIFICATION / UK CONFORMITY ASSESSMENT AND EUROPEAN CERTIFICATION



PRODOTTI COSTRUITI CON MATERIALE RICICLABILE / PRODUCTS MADE OF RECYCLABLE MATERIAL



GARANZIA DI 5 ANNI / 5-YEAR WARRANTY



FISSO / FIXED



ORIENTABILE / ADJUSTABLE



IDONEI PER CARTONGESSO OR LATERIZIO / CALCESTRUZZO a seconda dei modelli e degli accessori. SUITABLE FOR PLASTERBOARD OR BRICKWALL / CONCRETE it depends on the model and its accessories.

KELVIN

27		2700°K
30		3000°K
35		3500°K
40		4000°K

FASCIO / BEAM

S		SPOT 20°
F		FLOOD 32°
W		WIDE 50°
Z		ASYMMETRIC 41°X18°

FINITURE STANDARD / STANDARD FINISHINGS

/ 01		TELAIO BIANCO OTTICA NERA / WHITE FRAME BLACK OPTIC
/ 02		TELAIO NERO OTTICA NERA / BLACK FRAME BLACK OPTIC
/ 41		TELAIO BIANCO OTTICA BIANCA / WHITE FRAME WHITE OPTIC
/ 42		TELAIO NERO OTTICA ORO / BLACK FRAME GOLD OPTIC

TW



Tunable White 2700 – 5000°K

La tecnologia Tunable White consente di controllare la temperatura di colore delle sorgenti luminose permettendo di scegliere quella più adatta tra luce bianca calda e fredda. / Tunable White technology allows you to control the color temperature of light sources allowing you to choose the most suitable between warm and cold white light.

FINITURE PREMIUM / PREMIUM FINISHINGS

81-ORO ROSA / PINK GOLD	82-BRONZO ANTICATO/ANTIQUÉ BRONZE	83-OTTONE SATINATO/ BRUSHED BRASS

CURVE FOTOMETRICHE / PHOTOMETRIC DATA

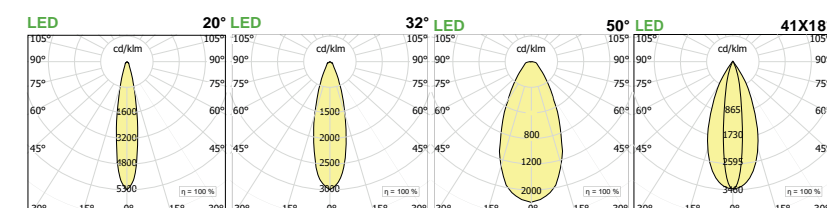

LEVA COLLECTION

MINIMAL SERIE
LINEARI / LINEAR VERSION

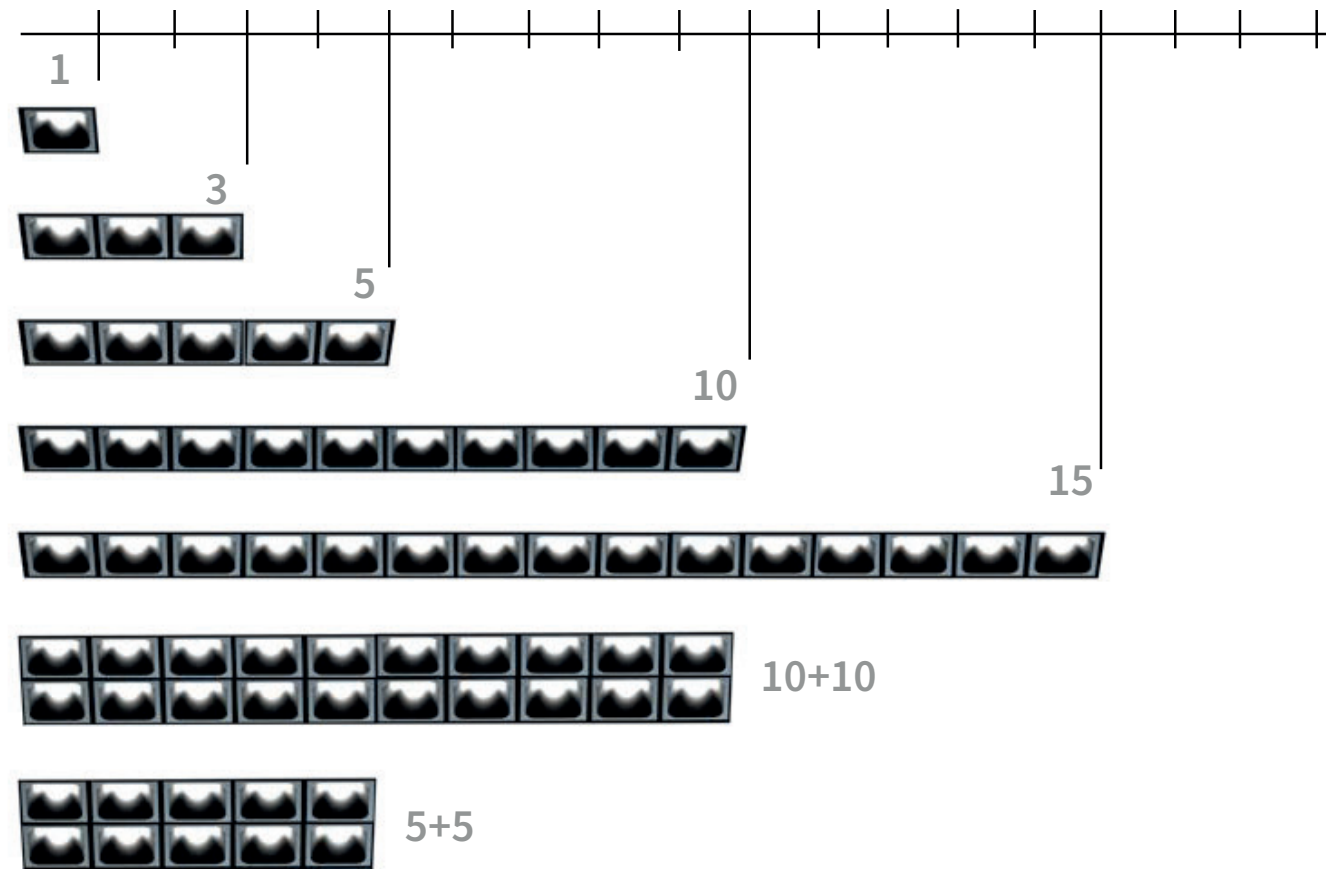

QUADRA

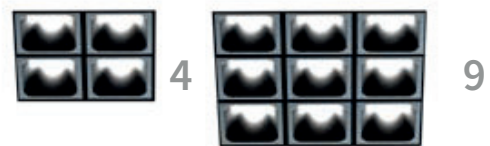

BASCULANTI / TILT VERSION

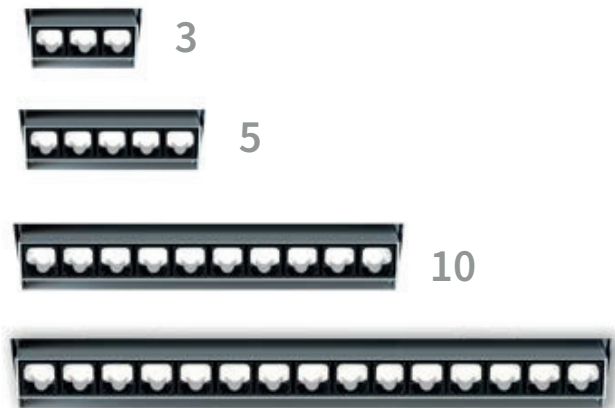

ROTOTRASLANTE /
SOFT ROTATE
& SLIDE



FRAME SERIE
LINEARI / LINEAR VERSION

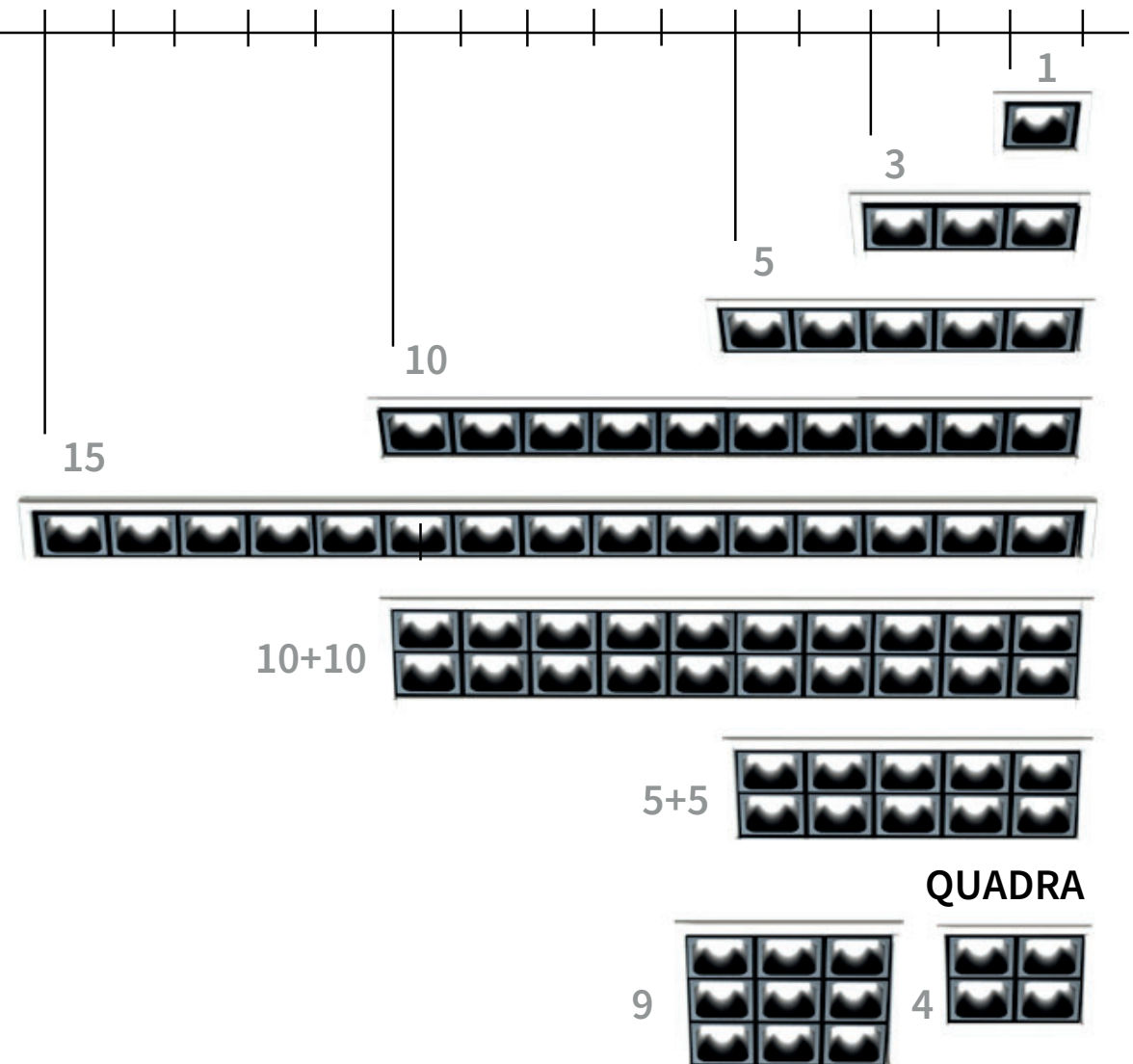

DOWNLIGHT

LEVA INCASSI | DOWNLIGHT

TRIMLESS

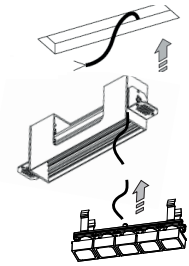

OR FRAME

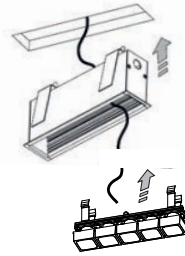

LEVA1 INCASSO DOWNLIGHT

TRIMLESS A+C



CASSA OBBLIGATORIA SENZA CORNICE - COMPULSORY TRIMLESS BOX							
Dim.	H	Kg	CODE				
30x34	62	0,06	LV001A				

FRAME B+C



CASSA OBBLIGATORIA CON CORNICE - COMPULSORY FRAME BOX							
Dim.	H	Kg	CODE	###			
40x42	62	0,06	LV001F	/01	/02		



KIT LED								Im prod./beam 3000K						
W	mA	Dim.	H	Kg	S20°	F32°	W50°	Z41°x18°	CODE					
2,2	700	27x30	60	0,02	200	186	166	175	LV001K.9	●●●	/##			

Da completare con cassa e alimentatore da installare remoto in scatola di derivazione | To be completed with box and power supply to be installed in a remote junction box

LEVA3 INCASSO DOWNLIGHT

TRIMLESS A+C

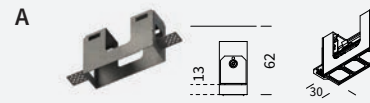

CASSA OBBLIGATORIA SENZA CORNICE - COMPULSORY TRIMLESS BOX							
Dim.	H	Kg	CODE				
30x94	62	0,12	LV003A				

FRAME B+C

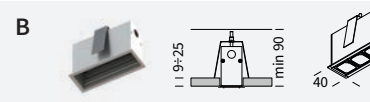

CASSA OBBLIGATORIA CON CORNICE - COMPULSORY FRAME BOX							
Dim.	H	Kg	CODE	###			
40x102	65	0,12	LV003F	/01	/02		



KIT LED								Im prod./beam 3000K						
W	mA	Dim.	H	Kg	S20°	F32°	W50°	Z41°x18°	CODE					
6,6	700	27x90	60	0,06	601	558	496	526	LV003K.9	●●●	/##			

Da completare con cassa e alimentatore da installare remoto in scatola di derivazione | To be completed with box and power supply to be installed in a remote junction box

LEVA5 INCASSO DOWNLIGHT

TRIMLESS A+C



CASSA OBBLIGATORIA SENZA CORNICE - COMPULSORY TRIMLESS BOX							
Dim.	H	Kg	CODE				
30x154	62	0,15	LV005A				

FRAME B+C

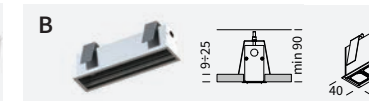

CASSA OBBLIGATORIA CON CORNICE - COMPULSORY FRAME BOX							
Dim.	H	Kg	CODE	###			
40x162	65	0,15	LV005F	/01	/02		



KIT LED								Im prod./beam 3000K						
W	mA	Dim.	H	Kg	S20°	F32°	W50°	Z41°x18°	CODE					
11	700	27x150	60	0,10	1002	931	828	877	LV005K.9	●●●	/##			

Da completare con cassa e alimentatore da installare remoto in scatola di derivazione | To be completed with box and power supply to be installed in a remote junction box

LEVA10 INCASSO DOWNLIGHT

TRIMLESS A+C



CASSA OBBLIGATORIA SENZA CORNICE - COMPULSORY TRIMLESS BOX							
Dim.	H	Kg	CODE				
30x304	62	0,27	LV010A				

FRAME B+C



CASSA OBBLIGATORIA CON CORNICE - COMPULSORY FRAME BOX							
Dim.	H	Kg	CODE	###			
40x312	60	0,35	LV010F	/01	/02		



KIT LED								Im prod./beam 3000K						
W	mA	Dim.	H	Kg	S20°	F32°	W50°	Z41°x18°	CODE					
22	700	27x300	60	0,20	2004	1862	1656	1754	LV010K.9	●●●	/##			

Da completare con cassa e alimentatore da installare remoto in scatola di derivazione | To be completed with box and power supply to be installed in a remote junction box

LEVA 15 INCASSO

TRIMLESS A+C



CASSA OBBLIGATORIA SENZA CORNICE - COMPULSORY TRIMLESS BOX							
Dim.	H	Kg	CODE				
33x456	62	0,35	LV015A / 01				

FRAME B+C



CASSA OBBLIGATORIA CON CORNICE - COMPULSORY FRAME BOX							
Dim.	H	Kg	CODE	###			
40x462	60	0,35	LV015F	/01	/02		



KIT LED								Im prod./beam 3000K						
W	mA	Dim.	H	Kg	20°	32°	50°	41°x18°	CODE					
33	700	27x450	60	0,35	3000	2793	2484	2631	LV015K.9	●●●	/##			

Da completare con cassa e alimentatore da installare remoto in scatola di derivazione | To be completed with box and power supply to be installed in a remote junction box

VERSIONI DISPONIBILI / AVAILABLE VERSION

● KELVIN	● FASCIO / BEAM	## FINITURA FINISHING
27 2700K	S Spot	/ 01 bianco white
30 3000K	F Flood	/ 02 nero black
35 3500K	W Wide	/ 04 oro gold
40 4000K	Z Asymmetric	
TW Tunable White		

Per i gradi vedere in tabella - For degrees check the table

COMPOSIZIONE CODICE: xxx.x ●● /##

HOW TO CREATE THE CODE: F1000.827S /01



700 DRIVERS VEDI | SEE P.452

ACCESSORI OPZIONALI / OPTIONAL ACCESSORIES

CASSAFORMA PER MURATURA E CALCESTRUZZO | WALLBOX FOR BRICKWALL OR CONCRETE

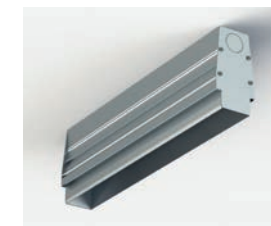

	CODE
LEVA 3 INCASSO	CCLV03
LEVA 5 INCASSO	CCLV05
LEVA 10 INCASSO	CCLV10
LEVA 15 INCASSO	CCLV15

VEDI "CASSAFORME PER MURATURA E CALCESTRUZZO" | WALLBOX FOR BRICK WALL AND CONCRETE" a pagina 119

LEVA 5+5 INCASSO | DOWNLIGHT

TRIMLESS A+C

A CASSA OBBLIGATORIA CON CORNICE - COMPULSORY FRAME BOX

Dim.	H	CODE
79x156	75	LV205A

FRAME B + C

B CASSA OBBLIGATORIA CON CORNICE - COMPULSORY FRAME BOX

Dim.	Hmm	CODE	Col.
88.5x165	min.120	LV205F	/01 /02

C

KIT LED		Dim.	Hmm	Im prod./beam 3000K			CODE
W	mA			20°	32°	50°	
22	700	75x150	70	2004	1862	1656	LV205K.9 ●● / ##

Da completare con cassa e alimentatore da installare remoto in scatola di derivazione | To be completed with box and power supply to be installed in a remote junction box

LEVA 10+10 INCASSO | DOWNLIGHT

TRIMLESS A+C

A CASSA OBBLIGATORIA CON CORNICE - COMPULSORY FRAME BOX

Dim.	H	CODE
79x306	75	LV210A / 01

FRAME B + C

B CASSA OBBLIGATORIA CON CORNICE - COMPULSORY FRAME BOX

Dim.	Hmm	CODE	Col.
89x315	min.120	LV210F	/01 /02

C

KIT LED		Dim.	Hmm	Im prod./beam 3000K			CODE
W	mA			20°	32°	50°	
44	700	75x300	120	4008	3724	3312	LV210K.9 ●● / ##

Da completare con cassa e alimentatore da installare remoto in scatola di derivazione | To be completed with box and power supply to be installed in a remote junction box

VERSIONI DISPONIBILI / AVAILABLE VERSION

- **KELVIN**
- 27 2700K
- 30 3000K
- 35 3500K
- 40 4000K
- TW Tunable White

- **FASCIO / BEAM**
- S Spot
- F Flood
- W Wide
- Z Asymmetric

- /## **FINITURA** | FINISHING
- /01 bianco | white
 - /02 nero | black
 - /04 oro | gold

COMPOSIZIONE CODICE: xxx.x ●● /##
 HOW TO CREATE THE CODE: **F1000.827S/01**
 CODE

F1000.8 | ●● | /## finishing
 base code kelvin beam

Per i gradi vedere in tabella -
 For degrees check the table

700 DRIVERS VEDI | SEE P.452

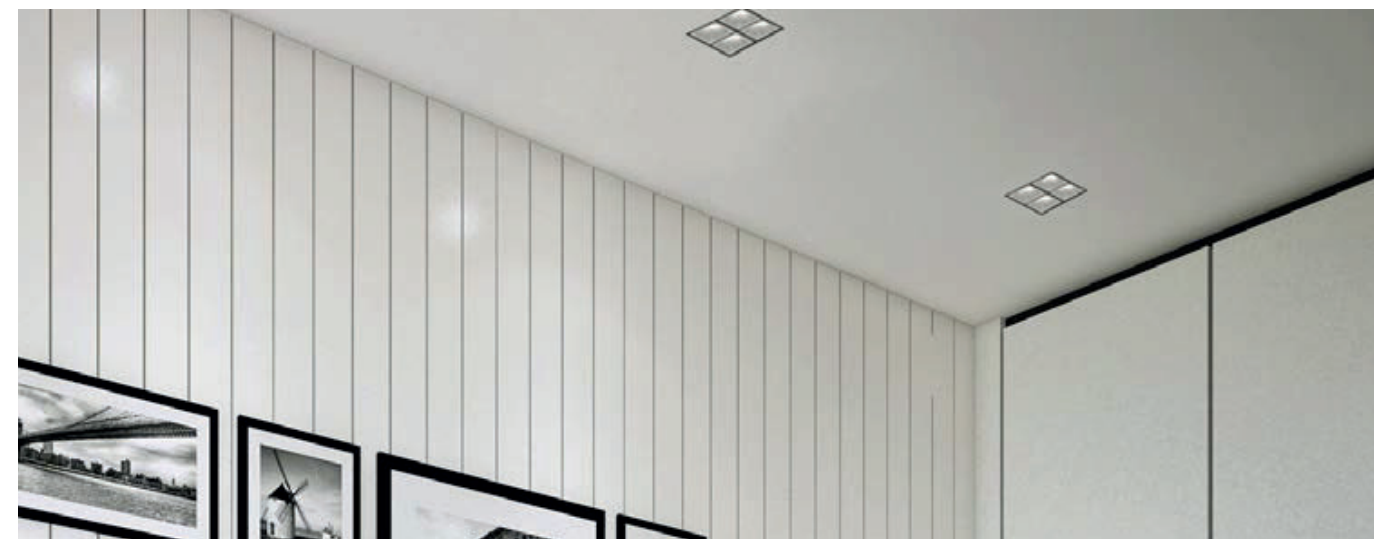

LEVA QUADRA TRIMLESS OR FRAME

LEVA QUADRA 4 INCASSO | DOWNLIGHT

TRIMLESS A+C

A CASSA OBBLIGATORIA - COMPULSORY BOX

Dim.	H	Kg	CODE
64x64	34	0,07	LV301M

FRAME B + C

B CASSA OBBLIGATORIA - COMPULSORY BOX

Dim.	H	Kg	CODE	/##
73x73	60	0,15	LV301F	/01 /02

C

KIT LED		Dim.	H	Kg	Im product/beam 3000K			CODE
W	mA				S20°	F32°	W50°	
8,8	700	61x61	33	0,2	800	745	662	LV351K.9 ●● / ##

Accessori - accessories: LV301M: Q4 cassa minimal - Q4 box minimal
 Da completare con alimentatore remoto | To be completed with remote driver

LEVA QUADRA 9 INCASSO | DOWNLIGHT

TRIMLESS A+C

A CASSA OBBLIGATORIA - COMPULSORY BOX

Dim.	H	Kg	CODE
94x94	34	0,12	LV302M

FRAME B + C

B CASSA OBBLIGATORIA - COMPULSORY BOX

Dim.	H	Kg	CODE	/##
103x103	60	0,25	LV302F	/01 /02

C

KIT LED		Dim.	H	Kg	Im product/beam 3000K			CODE
W	mA				S20°	F32°	W50°	
19,8	700	91x91	33	0,35	1800	1676	1490	LV352K.9 ●● / ##

Accessori - accessories: LV302M: Q9 cassa minimal - Q9 box minimal
 Da completare con alimentatore remoto | To be completed with remote driver

LEVA INCASSI MINIMAL BASCULANTE

CASSE IDONEE SIA DA CARTONGESSO CHE DA CALCESTRUZZO | SUITABLE BOXES FOR BOTH PLASTERBOARD AND CONCRETE

LEVA 3 INCASSO RASATO BASCULANTE TILT VERSION TRIMLESS



CASSA OBBLIGATORIA - COMPULSORY BOX		Dim.	H	Kg	98X118	CODE	Col.
		97x116	123	0,12		LV003B	/01 /02
KIT LED		W	Dim.	H	Kg	Im prod./beam 3000K S20° F32° W50° Z41°x18°	CODE
		6,6	75x100	110+38	1,23	601 558 496 526	LV041K.9 ●●● / ##

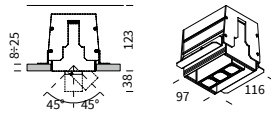

LEVA 5 INCASSO RASATO BASCULANTE TILT VERSION TRIMLESS DOWNLIGHTER



CASSA OBBLIGATORIA - COMPULSORY BOX		Dim.	H	Kg	99X178	CODE	Col.
		97x176				LV005B	/01 /02
KIT LED		W	Dim.	H	Kg	Im prod./beam 3000K S20° F32° W50° Z41°x18°	CODE
		11	75x160	110+38	1,67	1002 931 828 877	LV042K.9 ●●● / ##

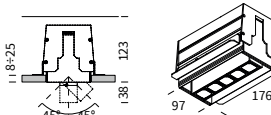

LEVA 10 INCASSO RASATO BASCULANTE TILT VERSION TRIMLESS DOWNLIGHTER



CASSA OBBLIGATORIA - COMPULSORY BOX		Dim.	H	Kg	99X328	CODE	Col.
		97x326				LV010B	/01 /02
KIT LED		W	Dim.	H	Kg	Im prod./beam 3000K S20° F32° W50° Z41°x18°	CODE
		22	75x310	110+38	2,26	2004 1862 1656 1754	LV043K.9 ●●● / ##

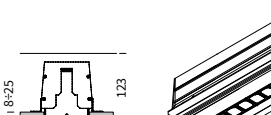

LEVA 15 INCASSO RASATO BASCULANTE TILT VERSION TRIMLESS DOWNLIGHTER



CASSA OBBLIGATORIA - COMPULSORY BOX		Dim.	H	Kg	99X478	CODE	Col.
		97x476				LV115B	/01 /02
LED KIT LED		W	Dim.	H	Kg	Im prod./beam 3000K S20° F32° W50° Z41°x18°	CODE
		33	75x460	110+38		3006 2793 2484 2631	LV044K.9 ●●● / ##

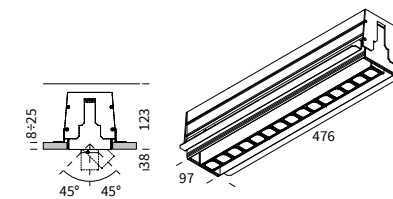

Da completare con cassa e alimentatore da installare remoto in scatola di derivazione | To be completed with box and power supply to be installed in a remote junction box

LEVA 5 INCASSO RASATO ROTOTRASLANTE SOFT ROTATE & SLIDE MECHANISM TRIMLESS DOWNLIGHTER



CASSA OBBLIGATORIA - COMPULSORY BOX		Dim.	H	Kg	85X233	CODE	Col.
		97x250				LV005C	/01 /02
LED KIT LED		W	mA	Dim.	H	Im prod./beam 3000K S20° F32° W50° Z41°x18°	CODE
		11	700	80x231	140	1000 931 828	LV051K.9 ●●● / ##

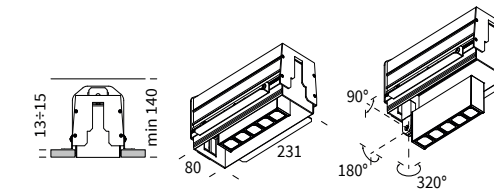

Da completare con cassa e alimentatore da installare remoto in scatola di derivazione | To be completed with box and power supply to be installed in a remote junction box

ACCESSORI / ACCESSORIES

KIT LUCE INTERNA PER ILLUMINARE LA CASSA INTERNAL LIGHT KIT

linea di luce - LED line	Im prod	CODE
W 7,5	924	LVKIT5 ●

VERSIONI DISPONIBILI / AVAILABLE VERSION

- **KELVIN**
- 27 2700K
- 30 3000K
- 35 3500K
- 40 4000K
- TW Tunable White

- **FASCIO / BEAM**
- S Spot
- F Flood
- W Wide
- Z Asymmetric

/ ## FINITURA CASSA | BOX FINISHING

- /01 bianco | white
- /02 nero | black

/ ## FINITURA KIT LED | KIT LED FINISHING

- /01 telaio bianco, ottica nera | white frame, black optic
- /02 telaio nero, ottica nera | black frame, black optic
- /41 telaio bianco, ottica bianca | white frame, white optic
- /42 telaio nero, ottica oro | black frame, gold optic

○ **KELVIN**

- 27 2700K
- 30 3000K
- 35 3500K
- 40 4000K

Per i gradi vedere in tabella -
For degrees check the table

CASSAFORME PER MURATURA E CALCESTRUZZO
WALLBOX FOR BRICK WALL AND CONCRETE



ACCESSORI OPTIONAL/ OPTIONAL ACCESSORIES
CASSAFORME PER MURATURA E CALCESTRUZZO | WALLBOX FOR BRICK WALL AND CONCRETE

CASSAFORMA PER LEVA3 | WALLBOX FOR LEVA3

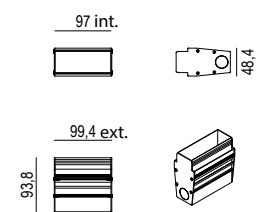

	L. mm int.	L.mm ext.	WxH
LEVA 3	97	99,4	48,4 X 93,8

CODE
CCLV03

CASSAFORMA PER LEVA5 | WALLBOX FOR LEVA5

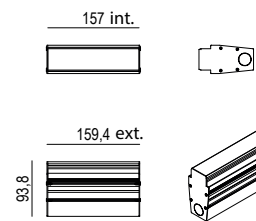
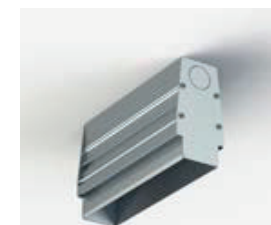

	L. mm int.	L.mm ext.	WxH
LEVA 5	157	159,4	48,4 X 93,8

CODE
CCLV05

CASSAFORMA PER LEVA10 | WALLBOX FOR LEVA10

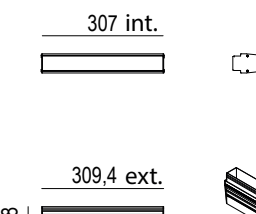
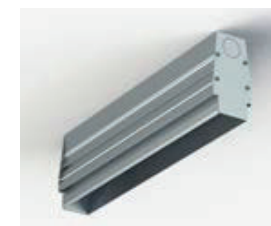

	L. mm int.	L.mm ext.	WxH
LEVA 10	307	309,4	48,4 X 93,8

CODE
CCLV10

CASSAFORMA PER LEVA15 | WALLBOX FOR LEVA15

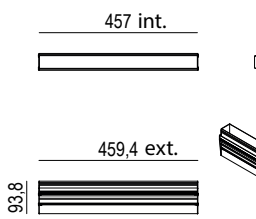
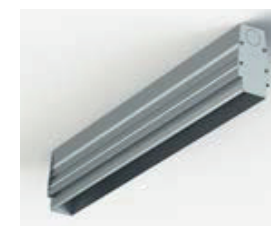

	L. mm int.	L.mm ext.	WxH
LEVA 15	457	459,4	48,4 X 93,8

CODE
CCLV15



MINISIGHT

MINISIGHT

MINIMAL



FRAME



Proiettore da incasso, per installazioni trimless o con battuta, dotato di gruppo ottico telescopico estraibile e orientabile, per sorgenti LED integrate o lampade LED GU10 230V / 240V, con corpo e monocolo telescopico in metallo verniciato. La versione trimless necessita obbligatoriamente di controtelaio per installazione su controsoffitti in cartongesso da 13mm. Per gli articoli a sorgenti led integrate alimentazione elettronica in remoto disponibile come accessorio. Installabile anche in pareti e soffitti in calcestruzzo mediante apposita cassaforma in lamiera zincata disponibile come accessorio. Grado di protezione IP20 / IP23.

Recessed projector, for trimless or trimmed installations, equipped with extractable and adjustable telescopic optical unit, for integrated LED sources or GU10 LED light bulbs 230V / 240V, with telescopic body and monocolo in painted metal. The trimless version necessarily requires a counterframe for installation on 13mm plasterboard ceilings. For articles with integrated LED sources, remote electronic power supply available as accessory. Extruded aluminum formwork for concrete recessed installation available as an accessory. IP20 / IP23.



UK CONFORMITY ASSESSMENT E EUROPEAN CERTIFICATION / UK CONFORMITY ASSESSMENT AND EUROPEAN CERTIFICATION



PRODOTTI COSTRUITI CON MATERIALE RICICLABILE / PRODUCTS MADE OF RECYCLABLE MATERIAL



GARANZIA DI 5 ANNI / 5-YEAR WARRANTY



ORIENTABILE / ADJUSTABLE

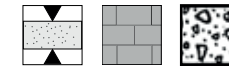

IDONEI PER CARTONGESSO OR LATERIZIO / CALCESTRUZZO a seconda dei modelli e degli accessori. SUITABLE FOR PLASTERBOARD OR BRICKWALL / CONCRETE it depends on the model and its accessories.

KELVIN

27		2700°K
30		3000°K
35		3500°K
40		4000°K

FASCIO / BEAM

S		SPOT 15°
F		FLOOD 27°
W		WIDE 46°

FINITURE STANDARD / STANDARD FINISHINGS

/01		BIANCO / WHITE
/02		NERO / BLACK

FINITURE PREMIUM / PREMIUM FINISHINGS

/81		ORO ROSA / ROSE GOLD
/82		BRONZO ANTICATO / ANTIQUE BRONZE
/83		OTTONE SATINATO / BRUSHED BRASS

CURVE FOTOMETRICHE / PHOTOMETRIC DATA

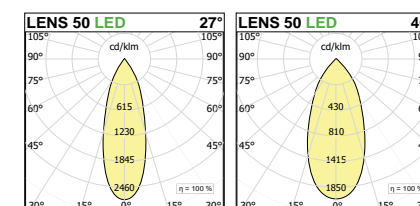

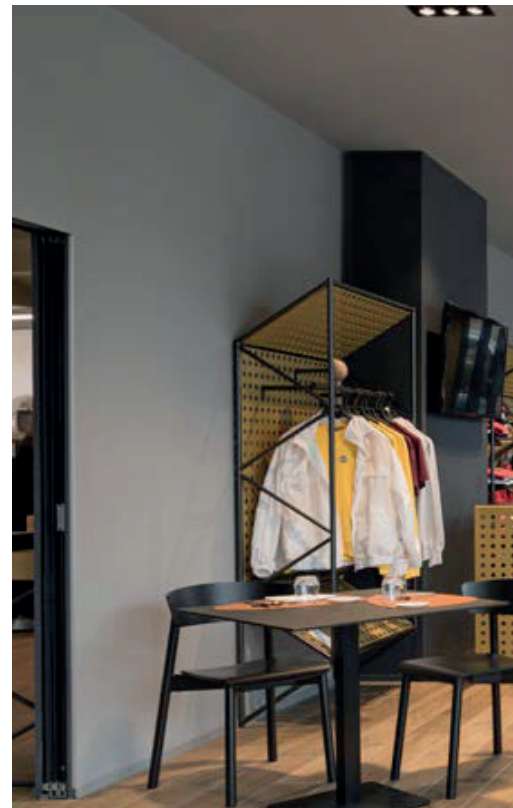

MINI SIGHT MINIMAL

MINI SIGHT 1M MINIMAL

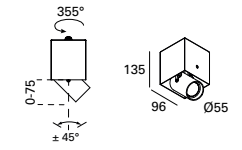

1 SCEGLIERE IL TELAIO O LA CASSA IN BASE AL TIPO DI INSTALLAZIONE / CHOOSE CASE OR FRAME ACCORDING TO THE TYPE OF INSTALLATION

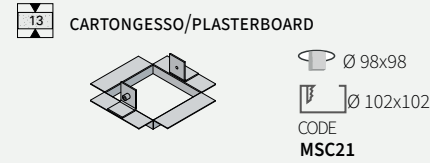

Telaio ispezionabile da fissare e stuccare nel cartongesso da 15mm, per cartongessi da 13mm spessorare inspectable frame to be fixed and plastered in 15mm height plasterboard false ceilings

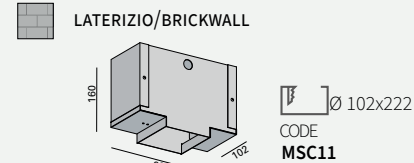

Cassaforma in lamiera zincata per installazione in laterizio o calcestruzzo - galvanized metal wallbox for installing in brick or reinforced concrete

2 SCEGLIERE IL GRUPPO OTTICO / CHOOSE OPTIC GROUP

LED										
W	mA	Dim.	Ø	H	α	Kg	S15°	F27°	W46°	CODE
12	350	96x96	55	135	45	0,66	1285	1285	1289	MS50.9 ●● / ##
18	500	96x96	55	135	45	0,66	1575	1575	1579	

GU10 LED 230V										
W	Dim.	Ø	H	α	Kg	CODE				
1x max 50	96x96	55	135	45	0,55	MS52 / ##				

MINI SIGHT 2M MINIMAL

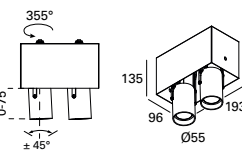

1 SCEGLIERE IL TELAIO O LA CASSA IN BASE AL TIPO DI INSTALLAZIONE / CHOOSE CASE OR FRAME ACCORDING TO THE TYPE OF INSTALLATION

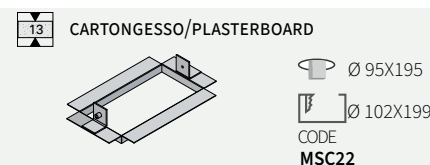

Telaio ispezionabile da fissare e stuccare nel cartongesso da 15mm, per cartongessi da 13mm spessorare inspectable frame to be fixed and plastered in 15mm height plasterboard false ceilings

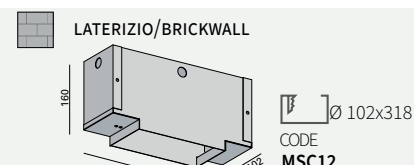

Cassaforma in lamiera zincata per installazione in laterizio o calcestruzzo - galvanized metal wallbox for installing in brick or reinforced concrete

2 SCEGLIERE IL GRUPPO OTTICO / CHOOSE OPTIC GROUP

LED										
W	mA	Dim.	Ø	H	α	Kg	S15°	F27°	W46°	CODE
24	350	96x193	55	135	45	1,05	2570	2570	2578	MS60.9 ●● / ##
36	500	96x193	55	135	45	1,05	3150	3150	3158	

GU10 LED										
W	Dim.	Ø	H	α	Kg	CODE				
2x max 50	96x193	55	135	45	1,00	MS62 / ##				

MINI SIGHT 3M MINIMAL

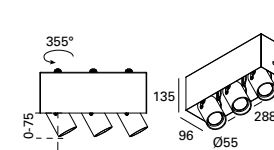

1 SCEGLIERE IL TELAIO O LA CASSA IN BASE AL TIPO DI INSTALLAZIONE / CHOOSE CASE OR FRAME ACCORDING TO THE TYPE OF INSTALLATION

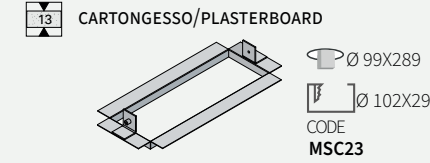

Telaio ispezionabile da fissare e stuccare nel cartongesso da 15mm, per cartongessi da 13mm spessorare inspectable frame to be fixed and plastered in 15mm height plasterboard false ceilings

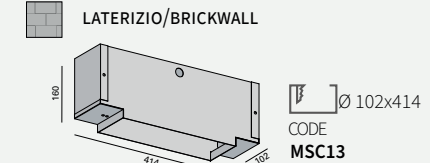

Cassaforma in lamiera zincata per installazione in laterizio o calcestruzzo - galvanized metal wallbox for installing in brick or reinforced concrete

2 SCEGLIERE IL GRUPPO OTTICO / CHOOSE OPTIC GROUP

LED										
W	mA	Dim.	Ø	H	α	Kg	S15°	F27°	W46°	CODE
36	350	96x288	55	135	45	1,50	3855	3855	3867	MS70.9
54	500	96x288	55	135	45	1,50	4725	4725	4737	

GU10 LED 230V										
W	Dim.	Ø	H	α	Kg	CODE				
3x50	96x288	55	135	45	1,25	MS72 / ##				

MINI SIGHT 4M MINIMAL

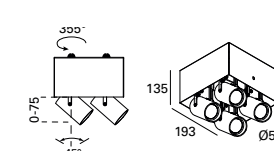

1 SCEGLIERE IL TELAIO O LA CASSA IN BASE AL TIPO DI INSTALLAZIONE / CHOOSE CASE OR FRAME ACCORDING TO THE TYPE OF INSTALLATION

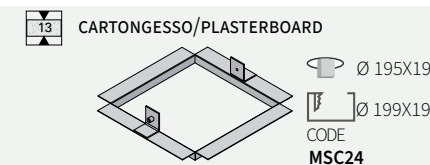

Telaio ispezionabile da fissare e stuccare nel cartongesso da 15mm, per cartongessi da 13mm spessorare inspectable frame to be fixed and plastered in 15mm height plasterboard false ceilings



Cassaforma in lamiera zincata per installazione in laterizio o calcestruzzo - galvanized metal wallbox for installing in brick or reinforced concrete

2 SCEGLIERE IL GRUPPO OTTICO / CHOOSE OPTIC GROUP

LED										
W	mA	Dim.	Ø	H	α	Kg	S15°	F27°	W46°	CODE
48	350	193x193	55	135	45	1,85	5140	5140	5156	MS80.9
72	500	193x193	55	135	45	1,85	6300	6300	6316	

GU10 LED 230V										
W	Dim.	Ø	H	α	Kg	CODE				
4x50	193x193	55	135	45	1,41	MS82				

VERSIONI DISPONIBILI / AVAILABLE VERSION

● KELVIN

- 27 2700K
- 30 3000K
- 35 3500K
- 40 4000K

TW Tunable White Dali

Note: Gli apparecchi con temperatura di colore variabile (Tunable White) vengono forniti comprensivi di alimentatore DALI | The devices with variable color temperature (Tunable White) are supplied with integrated DALI power supply.

● FASCIO / BEAM

- S Spot
- F Flood
- W Wide

/ ## FINITURA | FINISHING

- / 01 bianco | white
- / 02 nero | black

/ ## FINITURA PREMIUM | PREMIUM FINISHING

- / 81 oro rosa | rose gold
- / 82 bronzo anticato | antique bronze
- / 83 ottone brunito spazzolato | brushed burnished brass

COMPOSIZIONE CODICE: xxx.x ●● /

HOW TO CREATE THE CODE: **F1000.827S / 01**

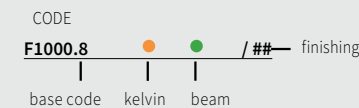

TW 350 500 DRIVERS VEDI | SEE P.452

ACCESSORI / ACCESSORIES

LENTI 50 / LENSES 50

	Ø	Kg	CODE
LENTE SATINATA / SATINED LENS	50	0,01	L050S / ##
LENTE ELISSOIDALE / ELIPSOID LENS	50	0,01	L050E / ##
LENTE ASIMMETRICA / ASYMMETRIC LENS	50	0,01	L050A / ##
FILTRO NIDO D'APE / HONEY COMB LOUVER	50	0,01	L050R / ##

MINI SIGHT FRAME

MINI SIGHT 1 FRAME

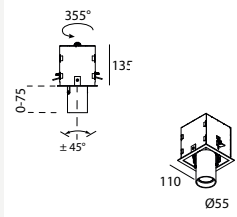

102X102											
LED											
W	mA	Dim.	Ø	H	α	Kg	S15°	F27°	W46°	CODE	
12	350	110x110	55	135	45	0,60	1285	1285	1289	MS10.9	●● / ##
18	500	110x110	55	135	45	0,60	1575	1575	1579		

GU10 LED 230V											
W	Dim.	Ø	H	α	Kg	CODE					
1x max 50	110x110	55	135	45	0,62	MS12 / ##					

Accessori - accessories: MSC01: cassaforma mini sight 1 - wallbox mini sight 1

MINI SIGHT 2 FRAME

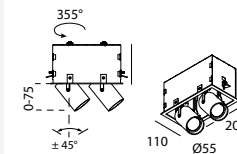

194X102											
LED											
W	mA	Dim.	Ø	H	α	Kg	S15°	F27°	W46°	CODE	
24	350	110x207	55	135	45	1,00	2570	2570	2578	MS20.9	●● / ##
36	500	110x207	55	135	45	1,00	3150	3150	3158		

GU10 LED 230V											
W	Dim.	Ø	H	α	Kg	CODE					
2x50	110x207	55	135	45	0,93	MS22 / ##					

Accessori - accessories: MSC02: cassaforma mini sight 2 - Wallbox mini sight 2

MINI SIGHT 3 FRAME

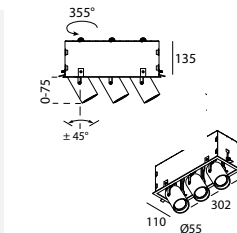

102X102											
LED											
W	mA	Dim.	H	α	Kg	S15°	F27°	W46°	CODE		
36	350	110x302	135	45	1,50	3855	3855	3867		MS30.9	●● / ##
54	500	110x302	135	45	1,50	4725	4725	4737			

GU10 LED 230V											
W	Dim.	H	α	Kg	CODE						
3x max 50	110x302	135	45	1,44	MS32 / ##						

Accessori - accessories: MSC03: cassaforma mini sight 3 - Wallbox mini sight 3

MINI SIGHT 4 FRAME

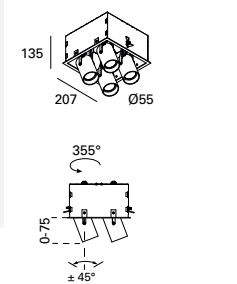

198X192											
LED											
W	mA	Dim.	Ø	H	α	Kg	S15°	F27°	W46°	CODE	
48	350	207x207	55	135	45	5140	5140	5156		MS40.9	●● / ##
72	500	207x207	55	135	45	6300	6300	6316			

GU10 LED 30V											
W	Dim.	Ø	H	α	CODE						
4x max 50	207x207	55	135	45	MS42 / ##						

Accessori - accessories: MSC04: cassaforma mini sight 4 - Wallbox mini sight 4

VERSIONI DISPONIBILI / AVAILABLE VERSION

- KELVIN**
 - 27 2700K
 - 30 3000K
 - 35 3500K
 - 40 4000K
- FASCIO / BEAM**
 - S Spot
 - F Flood
 - W Wide
- TW** Tunable White Dali

Note: Gli apparecchi con temperatura di colore variabile (Tunable White) vengono forniti comprensivi di alimentatore DALI | The devices with variable color temperature (Tunable White) are supplied with integrated DALI power supply.

COMPOSIZIONE CODICE: xxx.x ●● /

HOW TO CREATE THE CODE: **F1000.827S / 01**

CODE
F1000.8 ●● / ## — finishing
 base code kelvin beam

FINITURA PREMIUM / PREMIUM FINISHING

- / 01 bianco | white
- / 02 nero | black
- / 81 oro rosa / rose gold
- / 82 bronzo anticato | antique bronze
- / 83 ottone brunito spazzolato | brushed burnished brass

DRIVERS VEDI | SEE P.452



DOWNLIGHT

ACCESSORI OPZIONALI / OPTIONAL ACCESSORIES

CASSAFORMA MINI SIGHT FRAME WALLBOX MINI SIGHT FRAME

Cassaforma in lamiera zincata per installazione in laterizio o calcestruzzo - galvanized metal wallbox for installing in brick or reinforced concrete

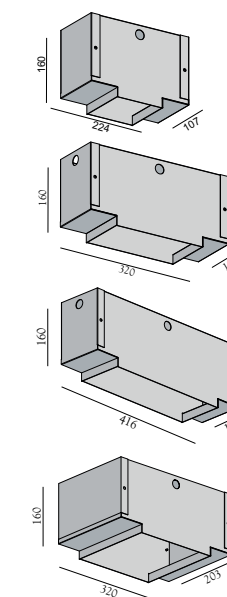

	Dim.	H	CODE
MINI SIGHT1	107x224	160	MSC01
MINI SIGHT2	107x320	160	MSC02
MINI SIGHT3	107x416	160	MSC03
MINI SIGHT4	203x320	160	MSC04



SIGHT

SIGHT

MINIMAL



FRAME



UK CONFORMITY ASSESSMENT E EUROPEAN CERTIFICATION / UK CONFORMITY ASSESSMENT AND EUROPEAN CERTIFICATION



PRODOTTI COSTRUITI CON MATERIALE RICICLABILE / PRODUCTS MADE OF RECYCLABLE MATERIAL



GARANZIA DI 5 ANNI / 5-YEAR WARRANTY











ORIENTABILE / ADJUSTABLE



IDONEI PER CARTONGESSO con telaio accessorio SUITABLE FOR PLASTERBOARD with its accessories.

DOWNLIGHT

KELVIN	FASCIO / BEAM	FINITURE STANDARD / STANDARD FINISHINGS
27  2700°K	S  SPOT 15°	/ 01  BIANCO / WHITE
30  3000°K	F  FLOOD 24°	/ 02  NERO / BLACK
35  3500°K	W  WIDE 38°	
40  4000°K		

Collezione di proiettori da incasso orientabili trimless o con battuta, con sorgente COB LED. Struttura in acciaio verniciato quadrata o rettangolare ad una o più sorgenti. Gruppo ottico telescopico estraibile e orientabile. La versione trimless necessita obbligatoriamente di controtelaio per installazione su controsoffitti in cartongesso da 13mm. Equipaggiati con LED ad alta resa, CRI >90, dissipatore passivo ad alte prestazioni in alluminio estruso anodizzato nero e riflettore metallizzato in alluminio 99,99%. Da associare a driver remoti stabilizzati in corrente. Equipaggiabile, all'occorrenza, con spettri per orticoltura. Installabile anche in pareti e soffitti in calcestruzzo mediante apposita cassaforma in lamiera zincata disponibile come accessorio Grado di protezione IP20 / IP23. zincata disponibile come accessorio. Grado di protezione IP20 / IP23.

Family of trimless or trimmed adjustable recessed spotlights, with COB LED source. Square or rectangular painted steel structure with one or more light sources. Removable and adjustable telescopic optical unit. The trimless version necessarily requires a counterframe for installation on 13mm plasterboard ceilings. Equipped with high-performance LEDs, CRI > 90, high-performance passive heat sink in black anodized extruded aluminum and metallized reflector in 99.99% aluminum. To be associated with remote drivers. They might be realized, if necessary, with spectra for horticulture. Extruded aluminum formwork for concrete recessed installation available as an accessory. IP20 / IP23.

CURVE FOTOMETRICHE / PHOTOMETRIC DATA

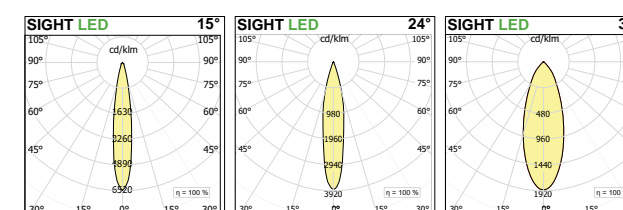

SIGHT MINIMAL

vedi accessori

SIGHT MINIMAL 1M

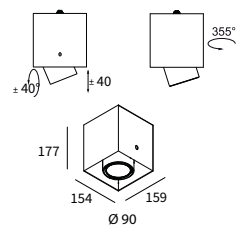
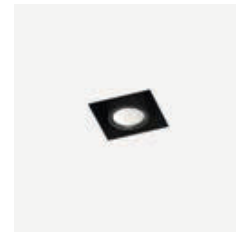

LED		Dim.		Im product/beam 3000K			CODE
W	mA	H	S15°	F24°	W38°		
17	500	159x154	177	1930	1827	1905	LT4301M.9 ●● / ##
24,3	700	159x154	177	2468	2356	2430	

Accessori - accessories: OBBLIGATORIO TEIN01M: telaio Incas 1AM - MANDATORY frame Incas 1AM
L085#A: Anello ø85 con lente - lens with ring ø85

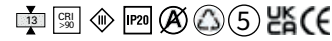

500 700

SIGHT MINIMAL 2M

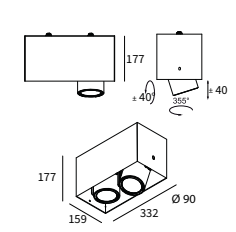

LED		Dim.		Im product/beam 3000K			CODE
W	mA	H	S15°	F24°	W38°		
2x17	500	159x332	177	3860	3654	3810	LT4304M.9 ●●● / ##
2x24,3	700	159x332	177	4936	4712	4860	

Accessori - accessories: OBBLIGATORIO TEIN02M: Telaio Incas 2AM - MANDATORY Frame Incas 2AM
OPTIONAL L085#A: Anello ø85 con lente - lens with ring ø85



500 700

SIGHT MINIMAL 3M

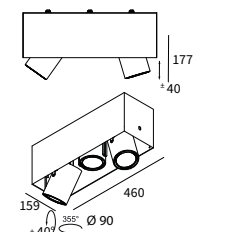

LED		Dim.		Im product/beam 3000K			CODE
W	mA	H	S15°	F24°	W38°		
3x17	500	159x460	177	5790	5481	5715	LT4309M.9 ●●● / ##
3x24,3	700	159x460	177	7404	7068	7290	

Accessori - accessories: OBBLIGATORIO TEIN03M: Telaio incas 3AM - MANDATORY Frame Incas 3AM
OPTIONAL L085#A: Anello ø85 con lente - lens with ring ø85



500 700

SIGHT FRAME

SIGHT FRAME 1F

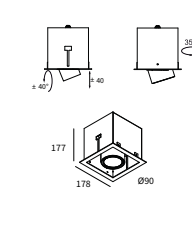

LED		Dim.		Im product/beam 3000K			CODE
W	mA	H	S15°	F24°	W38°		
17	500	178x178	177	1930	1827	1905	LT4301.9 ●●● / ##
24,3	700	178x178	177	2468	2356	2430	

Accessori - accessories: OPTIONAL L085#A: Anello ø85 con lente - lens with ring ø85



500 700

SIGHT FRAME 2F

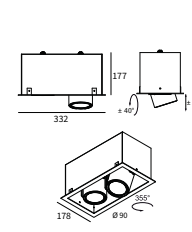

LED		Dim.		Im product/beam 3000K			CODE
W	mA	H	S15°	F24°	W38°		
2x17	500	178x332	177	3860	3654	3810	LT4304.9 ●●● / ##
2x24,3	700	178x332	177	4936	4712	4860	

Accessori - accessories: OPTIONAL L085#A: Anello ø85 con lente - lens with ring ø85



500 700

SIGHT FRAME 3F

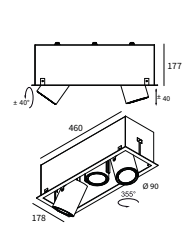

LED		Dim.		Im product/beam 3000K			CODE
W	mA	H	S15°	F24°	W38°		
3x17	500	178x460	177	5790	5481	5715	LT4309.9 ●●● / ##
3x24,3	700	178x460	177	7404	7068	7290	

Accessori - accessories: OPTIONAL L085#A: Anello ø85 con lente - lens with ring ø85



500 700

ACCESSORIO OBBLIGATORIO / MANDATORY ACCESSORIES

TELAIO SIGHT MINIMAL ISPEZIONABILE PER CARTONGESSO/PLASTERBOARD INSPECTABLE FRAME FOR SIGHT MINIMAL

Telaio ispezionabile da fissare e stuccare nel cartongesso da 15mm. Per cartongessi da 13mm spessorare - Inspectable frame to be fixed and plastered in 15mm height plasterboard false ceilings

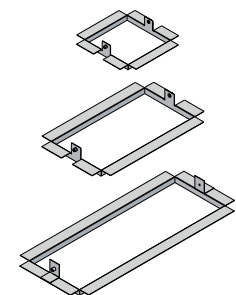

MODEL	Dim.	CODE
SIGHT MINIMAL 1M	162x163	TEIN01M
SIGHT MINIMAL 2M	316x163	TEIN02M
SIGHT MINIMAL 3M	470x163	TEIN03M

ACCESSORI OPZIONALI / OPTIONAL ACCESSORIES



DESCRIPTION	ø	Kg	CODE
LENTE SATINATA / SATINED LENS	85	0,01	L085S.A / ##
LENTE ELISSOIDALE / ELIPSOID LENS	85	0,01	L085E.A / ##
LENTE ASIMMETRICA / ASYMMETRIC LENS	85	0,01	L085A.A / ##
FILTRO NIDO DAPE / HONEY COMB LOUVER	85	0,01	L085R.A / ##

VERSIONI DISPONIBILI / AVAILABLE VERSION

KELVIN

- 27 2700K
- 30 3000K
- 35 3500K
- 40 4000K

FASCIO / BEAM

- S Spot 15°
- F Flood 24°
- W Wide 38°

FINITURA | FINISHING

- /01 bianco | white
- /02 nero | black

COMPOSIZIONE CODICE: xxx.x ●● /

HOW TO CREATE THE CODE: F1000.827S / 01

CODE
F1000.8 ●● / ## — finishing
base code kelvin beam

500 700 DRIVERS VEDI | SEE P.452



MINI INCAS

MINI INCAS

MINIMAL



FRAME



UK CONFORMITY ASSESSMENT E EUROPEAN CERTIFICATION / UK CONFORMITY ASSESSMENT AND EUROPEAN CERTIFICATION



PRODOTTI COSTRUITI CON MATERIALE RICICLABILE / PRODUCTS MADE OF RECYCLABLE MATERIAL



GARANZIA DI 5 ANNI / 5-YEAR WARRANTY



ORIENTABILE / ADJUSTABLE

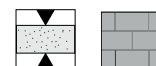

IDONEI PER CARTONGESSO OR LATERIZIO / CALCESTRUZZO a seconda dei modelli e degli accessori. SUITABLE FOR PLASTERBOARD OR BRICKWALL / CONCRETE it depends on the model and its accessories.

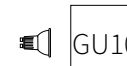

SORGENTE LED GU10 / GU10 LIGHT SOURCE

FINITURE STANDARD / STANDARD FINISHINGS

- / 01 BIANCO / WHITE
- / 02 NERO / BLACK

FINITURE PREMIUM / PREMIUM FINISHINGS

- / 81 ORO ROSA | ROSE GOLD
- / 82 BRONZO ANTICATO / ANTIQUE BRONZE
- / 83 OTTONE BRUNITO SPAZZOLATO | BRUSHED BURNISHED BRASS

Proiettore da incasso, per installazioni trimless o con battuta, dotato di monocolo telescopico estraibile e orientabile, per sorgente LED GU10 230V / 240V, con corpo e monocolo telescopico in metallo verniciato.

La versione trimless necessita obbligatoriamente di controtelaio per installazione su controsoffitti in cartongesso da 13mm. Installabile anche in pareti e soffitti in calcestruzzo mediante apposita cassaforma in lamiera zincata disponibile come accessorio. Grado di protezione IP20 / IP23

Recessed projector, for trimless or trimmed installations, equipped with removable and adjustable telescopic monocle, for GU10 LED source 230V / 240V, with body and telescopic monocle in painted metal.

The trimless version necessarily requires counterframe for installation on 13mm plasterboard false ceilings. Extruded aluminum formwork for concrete recessed installation available as an accessory. IP20 / IP23.

MONOCOLO TELESCOPICO ESTRAIBILE E ORIENTABILE



REMOVABLE AND ADJUSTABLE TELESCOPIC MONOCLE



MINI INCAS MINIMAL

MINI INCAS 1 MINIMAL

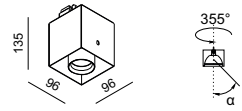

1 SCEGLIERE IL TELAIO O LA CASSA IN BASE AL TIPO DI INSTALLAZIONE CHOOSE CASE OR FRAME ACCORDING TO THE TYPE OF INSTALLATION

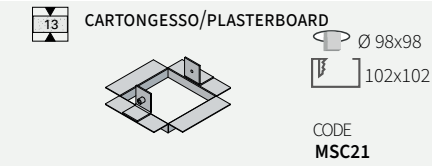

Telaio ispezionabile da fissare e stuccare nel cartongesso da 15mm, per cartongessi da 13mm spessorare inspectable frame to be fixed and plastered in 15mm height plasterboard false ceilings

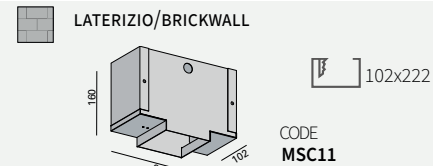

Cassaforma in lamiera zincata per installazione in laterizio o calcestruzzo - galvanized metal wallbox for installing in brick or reinforced concrete

2 GRUPPO OTTICO / OPTIC GROUP

GU10 LED	W	Dim.	Ø	H	α	Kg	CODE
1x max 50	96x96	55	135	45	0,55	LT1202 / ##	

MINI INCAS 2 MINIMAL

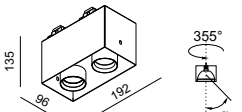

1 SCEGLIERE IL TELAIO O LA CASSA IN BASE AL TIPO DI INSTALLAZIONE CHOOSE CASE OR FRAME ACCORDING TO THE TYPE OF INSTALLATION

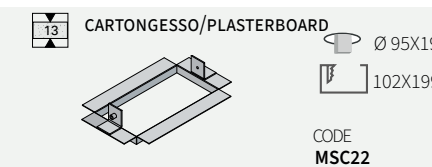

Telaio ispezionabile da fissare e stuccare nel cartongesso da 15mm, per cartongessi da 13mm spessorare inspectable frame to be fixed and plastered in 15mm height plasterboard false ceilings

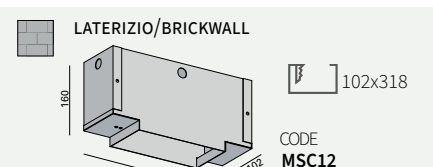

Cassaforma in lamiera zincata per installazione in laterizio o calcestruzzo - galvanized metal wallbox for installing in brick or reinforced concrete

2 GRUPPO OTTICO / OPTIC GROUP

GU10 LED	W	Dim.	Ø	H	α	Kg	CODE
2x max 50	96x193	55	135	45	1,00	LT1208 / ##	

MINI SIGHT 3M MINIMAL



1 SCEGLIERE IL TELAIO O LA CASSA IN BASE AL TIPO DI INSTALLAZIONE CHOOSE CASE OR FRAME ACCORDING TO THE TYPE OF INSTALLATION

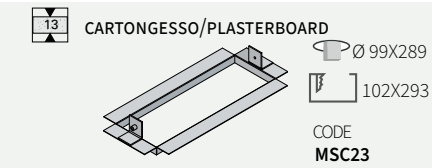

Telaio ispezionabile da fissare e stuccare nel cartongesso da 15mm, per cartongessi da 13mm spessorare inspectable frame to be fixed and plastered in 15mm height plasterboard false ceilings

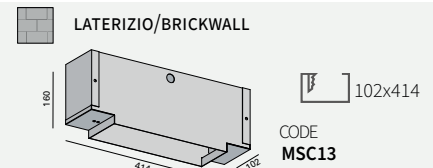

Cassaforma in lamiera zincata per installazione in laterizio o calcestruzzo - galvanized metal wallbox for installing in brick or reinforced concrete

2 GRUPPO OTTICO / OPTIC GROUP

GU10 LED/230V	W	Dim.	Ø	H	α	Kg	CODE
3x50	96x288	55	135	45	1,25	LT1216 / ##	

MINI INCAS FRAME

MINI INCAS 1 FRAME

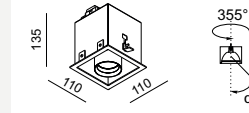

GU10 LED	W	Dim.	H	Kg	CODE
1x max 50	110x110	135	0,55	LT1205 / ##	

MINI INCAS 2 FRAME

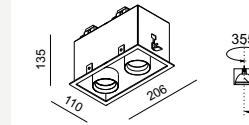
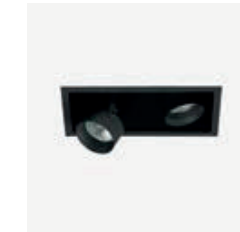

GU10 LED	W	Dim.	H	Kg	CODE
2x max 50	110x206	135	1,00	LT1212 / ##	

MINI INCAS 3 FRAME

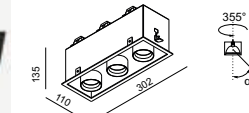

GU10 LED	W	Dim.	H	Kg	CODE
3x max 50	110x332	135	1,25	LT1220 / ##	

ACCESSORI OPZIONALI / OPTIONAL ACCESSORIES

CASSAFORMA PER LATERIZIO O CALCESTRUZZO MINI INCAS FRAME WALLBOX MINI INCAS FRAME FOR INSTALLING IN BRICK OR REINFORCED CONCRETE

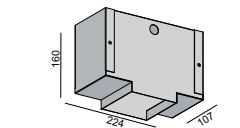

MINI INCAS 1 FRAME	Dim.	H	CODE
	107x224	160	MSC01

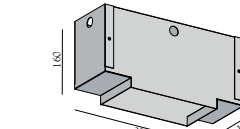

MINI INCAS 2 FRAME	Dim.	H	CODE
	107x320	160	MSC02

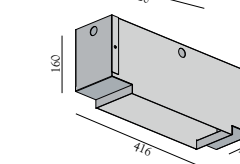

MINI INCAS 3 FRAME	Dim.	H	CODE
	107x416	160	MSC03

VERSIONI DISPONIBILI / AVAILABLE VERSION

/ ## FINITURA | FINISHING

- / 01 bianco | white
- / 02 nero | black

/ ## FINITURA PREMIUM / PREMIUM FINISHING

- / 81 oro rosa / rose gold
- / 82 bronzo anticato|antique bronze
- / 83 ottone brunito spazzolato|brushed burnished brass

COMPOSIZIONE CODICE: xxx. /

HOW TO CREATE THE CODE: **F1000 / 01**

CODE
F1000.8 / ## finishing
|
base code



INCAS

INCAS

MINIMAL



FRAME



UK CONFORMITY ASSESSMENT E EUROPEAN CERTIFICATION / UK CONFORMITY ASSESSTMENT AND EUROPEAN CERTIFICATION



PRODOTTI COSTRUITI CON MATERIALE RICICLABILE / PRODUCTS MADE OF RECYCLABLE MATERIAL



GARANZIA DI 5 ANNI / 5-YEAR WARRANTY



ORIENTABILE / ADJUSTABLE



IDONEI PER CARTONGESSO con telaio accessorio SUITABLE FOR PLASTERBOARD with its accessories.

KELVIN

27		2700°K
30		3000°K
35		3500°K
40		4000°K

FASCIO / BEAM

S		SPOT 15°
F		FLOOD 24°
W		WIDE 38°

FINITURE STANDARD / STANDARD FINISHINGS

/ 01		BIANCO / WHITE
/ 02		NERO / BLACK

Famiglia di incassi orientabili, con sorgente COB LED, per incasso trimless o con battuta. Struttura in acciaio verniciato quadrata o rettangolare ad una o più sorgenti. Gruppo ottico cardanico con orientamento $\pm 25^\circ$ sui due assi orizzontali. La versione trimless necessita obbligatoriamente di controtelaio per installazione su controsoffitti in cartongesso da 13mm. Equipaggiati con LED ad alta resa, CRI >90, dissipatore passivo ad alte prestazioni in alluminio estruso anodizzato nero e riflettore metallizzato in alluminio 99,99%. Da associare a driver remoti stabilizzati in corrente. Grado di protezione IP20 / IP23.

Family of trimless or trimmed adjustable recessed spotlights, with COB LED source. Square or rectangular painted steel structure with one or more light sources. Cardanic optical unit with $\pm 25^\circ$ orientation on the two horizontal axes. The trimless version necessarily requires a counterframe for installation on 13mm plasterboard ceilings. Equipped with high-performance LEDs, CRI > 90, high-performance passive heat sink in black anodized extruded aluminum and metallized reflector in 99.99% aluminum. To be associated with remote drivers. IP20 / IP23.

CURVE FOTOMETRICHE / PHOTOMETRIC DATA

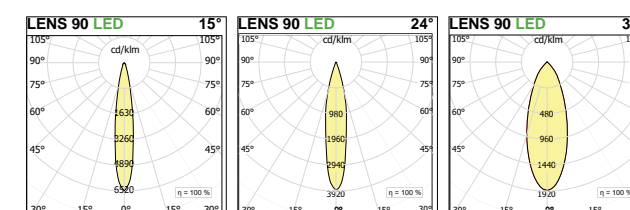



INCAS MINIMAL 1

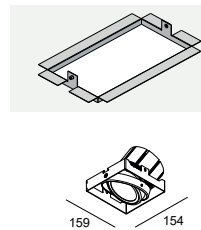
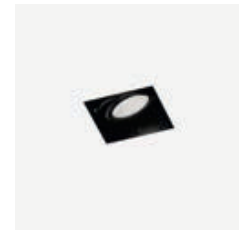

TELAIO PER CARTONGESSO OBBLIGATORIO - COMPULSORY FRAME FOR PLASTERBOARD			
160x163	H		CODE
	13		TEIN01M

GRUPPO OTTICO / OPTIC GROUP			
LED			Im product/beam 3000K
W	mA	Dim.	H
17	500	154x159	140
		S15°	F24° W38°
		1930	1827 1905
24,3	700	154x159	140
		2468	2356 2430
IN01M.9 ●● / ##			

Accessori - accessories: TEIN01M: telaio Incas 1AM - frame Incas 1AM
SOLO INSTALLAZIONE A CARTONGESSO - ONLY FOR PLASTERBOARD

INCAS MINIMAL 2

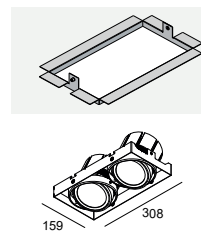

TELAIO PER CARTONGESSO OBBLIGATORIO - COMPULSORY FRAME FOR PLASTERBOARD			
314x163	H		CODE
	13		TEIN02M

GRUPPO OTTICO / OPTIC GROUP			
LED			Im product/beam 3000K
W	mA	Dim.	H
2x17	500	308x159	140
		S15°	F24° W38°
		3860	3654 3810
2x24,3	700	308x159	140
		4936	4712 4860
IN02M.9 ●● / ##			

Accessori - accessories: TEIN02M: telaio Incas 2AM - frame Incas 2AM
SOLO INSTALLAZIONE A CARTONGESSO - ONLY FOR PLASTERBOARD

INCAS MINIMAL 3

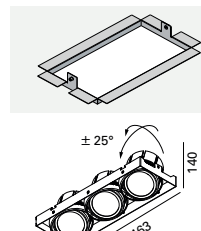

TELAIO PER CARTONGESSO OBBLIGATORIO - COMPULSORY FRAME FOR PLASTERBOARD			
469x163	H		CODE
	13		TEIN03M

GRUPPO OTTICO / OPTIC GROUP			
LED			Im product/beam 3000K
W	mA	Dim.	H
3x17	500	463x159	140
		S15°	F24° W38°
		5790	5481 5715
3x24,3	700	463x159	140
		7404	7068 7290
IN03M.9 ●● / ##			

Accessori - accessories: TEIN03M: telaio incas 3AM - frame Incas 3AM
SOLO INSTALLAZIONE A CARTONGESSO - ONLY FOR PLASTERBOARD

INCAS FRAME

INCAS 1

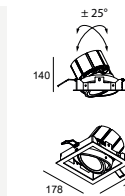

162x162	8-30	CRI 90	IP20	5	CE
---------	------	--------	------	---	----

SOLO PER CARTONGESSO - ONLY FOR PLASTERBOARD

500 700

LED	W	mA	Dim.	H	Im product/beam 3000K	CODE
			S15°	F24°	W38°	
17	500	178x178	140	1930	1827 1905	IN01.9 ●● / ##
24,3	700	178x178	140	2468	2356 2430	

INCAS 2

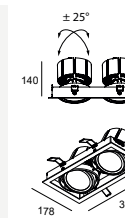

316x162	8-30	CRI 90	IP20	5	CE
---------	------	--------	------	---	----

SOLO PER CARTONGESSO - ONLY FOR PLASTERBOARD

500 700

LED	W	mA	Dim.	H	Im product/beam 3000K	CODE
			S15°	F24°	W38°	
2x17	500	332x178	140	3860	3654 3810	IN02.9 ●● / ##
2x24,3	700	332x178	140	4936	4712 4860	

INCAS 3

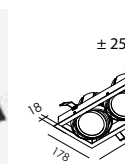

470x162	8-30	CRI 90	IP20	5	CE
---------	------	--------	------	---	----

SOLO PER CARTONGESSO - ONLY FOR PLASTERBOARD

500 700

LED	W	mA	Dim.	H	Im product/beam 3000K	CODE
			S15°	F24°	W38°	
3x17	500	487x178	140	5790	5481 5715	IN03.9 ●● / ##
3x24,3	700	487x178	140	7404	7068 7290	

VERSIONI DISPONIBILI / AVAILABLE VERSION

● KELVIN

- 27 2700K
- 30 3000K
- 35 3500K
- 40 4000K

● FASCIO / BEAM

- S Spot 15°
- F Flood 24°
- W Wide 38°

/ ## FINITURA | FINISHING

- /01 bianco | white
- /02 nero | black

COMPOSIZIONE CODICE: xxx.x ●● /

HOW TO CREATE THE CODE: F1000.827S / 01

CODE
F1000.8 | ●● | / ## — finishing
base code kelvin beam

500 700 DRIVERS VEDI | SEE P.452

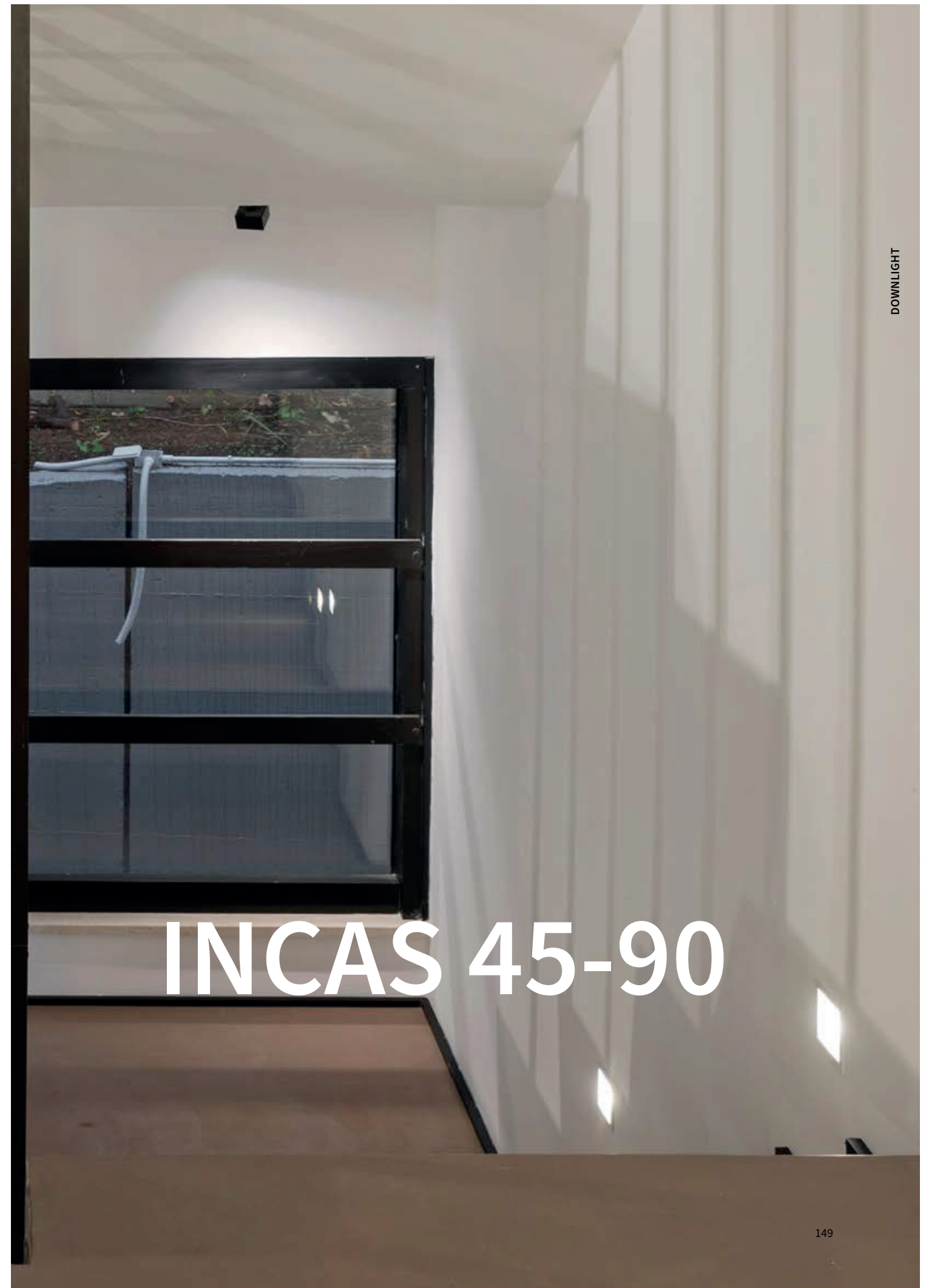
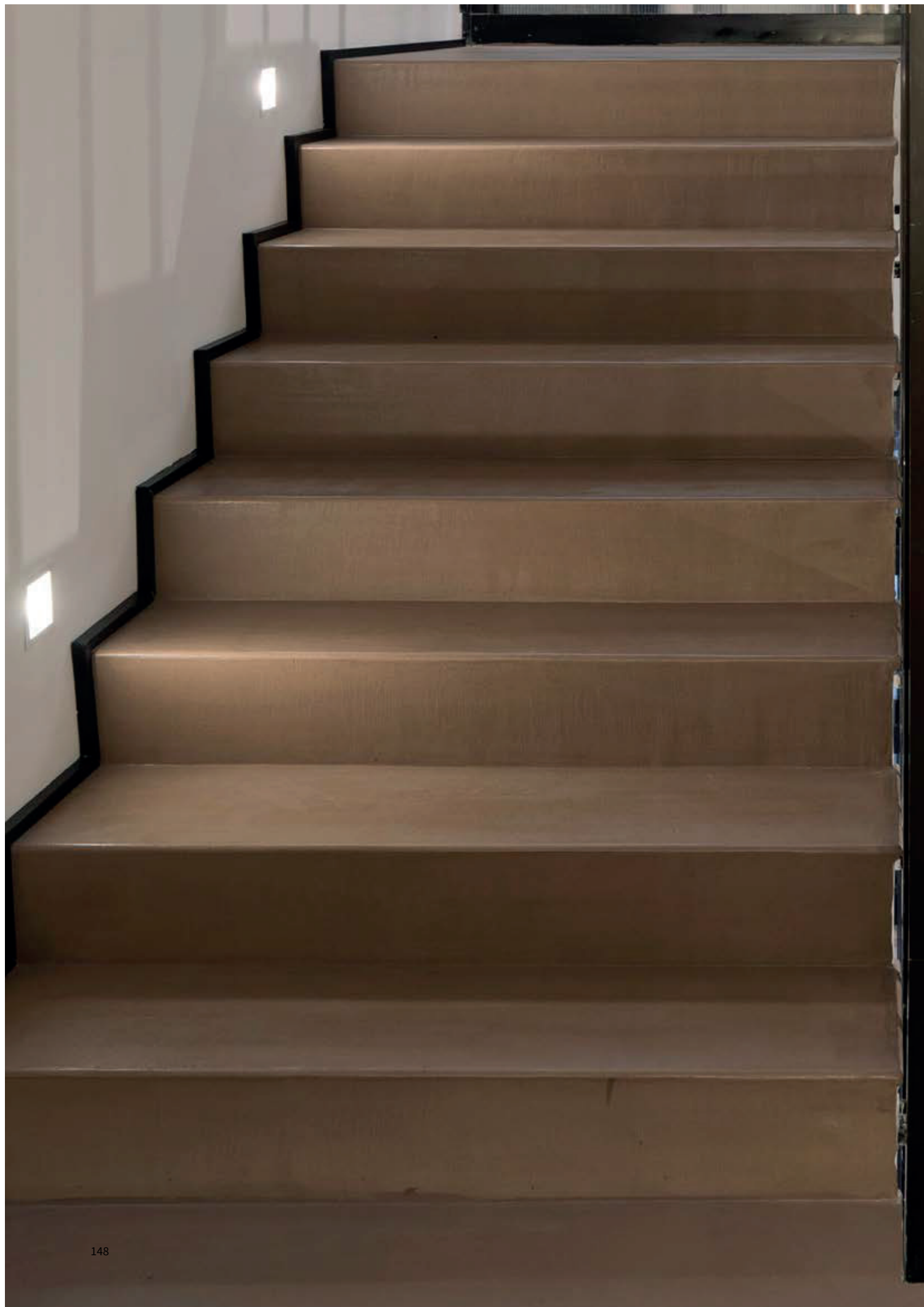

INCAS 45-90

DOWNLIGHT

INCAS 45 E 90

Apparecchio da incasso fisso per illuminazione d'accento o diffusa mediante impiego di vetro diffusore satinato disponibile come accessorio. Per sorgente LED integrata o per lampade LED GU10 230V / 240V. Alimentazione remota disponibile come accessorio per le sorgenti a LED integrate. Corpo e cornice di battuta metallo verniciato. Installabile, anche, in pareti e soffitti in calcestruzzo o laterizio mediante apposita cassaforma in lamiera zincata disponibile come accessorio. Grado di protezione IP20 / IP23.

Fixed recessed luminaire for accent or diffused lighting by using satin diffuser glass available as an accessory. For integrated LED source or for GU10 LED lamps 230V / 240V. Remote power supply available as an accessory for the integrated LED sources. Body and frame in painted metal. It can, also, be installed in concrete or brick ceilings using a special galvanized metal outercasing available as accessory. IP20 / IP23.

-  **UK CONFORMITY ASSESSMENT E EUROPEAN CERTIFICATION / UK CONFORMITY ASSESSTMENT AND EUROPEAN CERTIFICATION**
-  **PRODOTTI COSTRUITI CON MATERIALE RICICLABILE / PRODUCTS MADE OF RECYCLABLE MATERIAL**
-  **GARANZIA DI 5 ANNI / 5-YEAR WARRANTY**
-  **FISSO / FIXED**
-  **IDONEI PER CARTONGESSO O LATERIZIO / CALCESTRUZZO CON APPOSITA CASSAFORMA OPZIONALE SUITABLE FOR PLASTERBOARD OR BRICKWALL / CONCRETE WITH THE OPTIONAL BOX**

 **VERSIONE SORGENTE GU10 DISPONIBILE** GU10 LIGHT SOURCE VERSION AVAILABLE

FASCIO / BEAM



SPOT

FINITURE / FINISHINGS



01-BIANCO / WHITE

FINITURE PREMIUM / PREMIUM FINISHINGS



81-ORO ROSA / PINK GOLD



82 BRONZO ANTICATO / ANTIQUE BRONZE



83 OTTONE BRUNITO SPAZZOLATO / BRUSHED BURNISHED BRASS

FINITURA | FINISHING

 / 01 bianco | white

COMPOSIZIONE CODICE: xxx / ##

HOW TO CREATE THE CODE: F1000 / 01

CODE

F1000.8 / ## — finishing

base code

FINITURA PREMIUM | PREMIUM FINISHING

 / 81 oro rosa / rose gold

 / 82 bronzo anticato | antique bronze

 / 83 ottone brunito spazzolato | brushed burnished brass

 **DRIVERS VEDI | SEE P.452**

INCAS 45

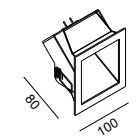

LED		Dim.		Im product / beam 3000K		CODE
W	mA		SZ2°			
5	500	100x100x80	460			IN45.930S / 01

QT-14 c G9 230V		Dim.		Im product / beam 3000K		CODE
W			SZ2°			
1x max 60		100x100x80	460			IN45G9 / 01

Accessori - accessories: VT / IN45.90: vetro diffusore satinato incas 45 / 90 - frosted glass diffuser - CC94: cassaforma incas 90 - 45 - Wallbox incas 90 - 45

INCAS 90

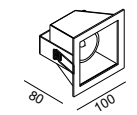

LED		Dim.		Im product / beam 3000K		CODE
W	mA		SZ2°			
5	500	100x100x80	460			IN90.930S / 01

GU10LED		Dim.		Im product / beam 3000K		CODE
W			SZ2°			
1x max 50		100x100x80	460			IN90GU / 01

Accessori - accessories: VT / IN45.90: vetro diffusore satinato incas 45 / 90 - frosted glass diffuser - CC94: cassaforma incas 90 - 45 - Wallbox incas 90 - 45

INCAS 45 MICRO

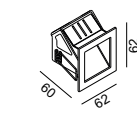

LED		Dim.		Im product / beam 3000K		CODE
W	mA		30°			
1,5	500	62x62x60	136			IN93L2 / 01

QT12-LP GY6,35 12V		Dim.		Im product / beam 3000K		CODE
W			30°			
1x max 35		62x62x60	136			IN93 / 01

Accessori - accessories: VT / IN92: vetro diffusore satinato incas 45 / 90 MICRO - frosted glass diffuser - CC94M: cassaforma incas 90 - 45 micro - wallbox incas 90 - 45 micro

INCAS 90 MICRO

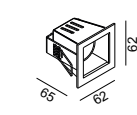

LED		Dim.		Im product / beam 3000K		CODE
W	mA		30°			
1,5	500	62x62x65	136			IN92L2 / 01

QR-CB35 GU4 12V		Dim.		Im product / beam 3000K		CODE
W			30°			
1x max 35		62x62x65	136			IN92 / 01

Accessori - accessories: VT / IN92: vetro diffusore satinato incas 45 / 90 MICRO - frosted glass diffuser - CC94M: cassaforma incas 90 - 45 micro - wallbox incas 90 - 45 micro

ACCESSORI OPZIONALI / OPTIONAL ACCESSORIES

VETRO DIFFUSORE SATINATO FROSTED GLASS DIFFUSER

L'inserimento di questo accessorio eleva il grado di protezione dell'apparecchio ad IP40 e IP43 | the inclusion of this accessory raises the protection degree of the lamp to IP40 and IP43

INCAS 45 / 90

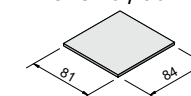

INCAS 45 / 90 MICRO

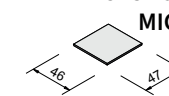

INCAS 45 / 90	81X84	CODE
INCAS45 / 90 MICRO	46X47	VT / IN45.90
		VT / IN92

CASSAFORMA PER LATERIZIO WALLBOX FOR BRICKWALL

INCAS 45 / 90

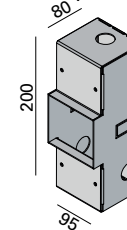

INCAS 45 / 90 MICRO

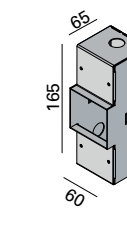

INCAS 45 / 90	CODE
INCAS 45 / 90 MICRO	CC94
	CC94M

Cassaforma in lamiera zincata per installazione in laterizio o calcestruzzo - galvanized metal wallbox for installing in brick or reinforced concrete



MINIFRAME

Apparecchio da incasso fisso per sorgente LED integrate o per lampade LED GU10 230V / 240V. Alimentazione remota disponibile come accessorio per sorgenti LED intergrate. Corpo e cornice di battuta in metallo verniciato. Installabile, anche, in pareti e soffitti in calcestruzzo o laterizio mediante apposita cassaforma in lamiera zincata disponibile come accessorio. Grado di protezione IP20 / IP23.

Fixed recessed luminaire for integrated LED source or for GU10 230V / 240V LED Light bulb. Remote power supply available as accessory for the integrated LED sources. Body and frame in painted metal. It can, also, be installed in concrete or brick ceilings using a special galvanized metal outercasing available as accessory. IP20 / IP23.



UK CONFORMITY ASSESSMENT E EUROPEAN CERTIFICATION / UK CONFORMITY ASSESSTMENT AND EUROPEAN CERTIFICATION



PRODOTTI COSTRUITI CON MATERIALE RICICLABILE / PRODUCTS MADE OF RECYCLABLE MATERIAL



GARANZIA DI 5 ANNI / 5-YEAR WARRANTY

FISSO / FIXED

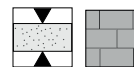

IDONEI PER CARTONGESSO O LATERIZIO / CALCESTRUZZO CON APPOSITA CASSAFORMA OPZIONALE SUITABLE FOR PLASTERBOARD OR BRICKWALL / CONCRETE WITH THE OPTIONAL BOX



SORGENTE LED DISPONIBILE GU10 LIGHT SOURCE AVAILABLE

KELVIN	FASCIO / BEAM
27 2700°K	F FLOOD
30 3000°K	W WIDE
35 3500°K	
40 4000°K	

FASCIO / BEAM
F FLOOD
W WIDE

FINITURE STANDARD / STANDARD FINISHINGS

/ 01	BIANCO / WHITE
/ 02	NERO / BLACK

FINITURE PREMIUM / PREMIUM FINISHINGS

/ 81	ORO ROSA ROSE GOLD
/ 82	BRONZO ANTICATO / ANTIQUE BRONZE
/ 83	OTTONE BRUNITO SPAZZOLATO / BURNISHED BRUSHED BRASS

CURVE FOTOMETRICHE / PHOTOMETRIC DATA

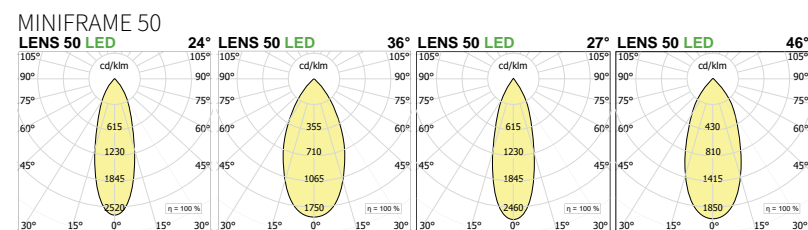
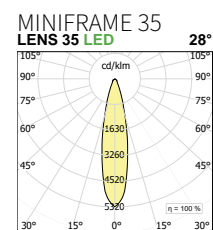

MINIFRAME 35

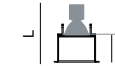
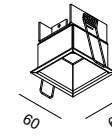

52X52 0-25 CRI >90 IP20 5 UK CA CE

SOLO PER CARTONGESSO - ONLY FOR PLASTERBOARD

LED W	mA	H	Im product / beam 3000K FZ2°	CODE
5	500	110	520	LT4102.9 ● F / ##

● disponibile solo fascio F available only F beam

MINIFRAME 50

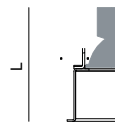
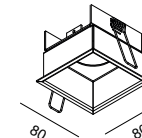

72X72 0-25 CRI >90 IP20 5 UK CA CE

SOLO PER CARTONGESSO - ONLY FOR PLASTERBOARD

LED W	mA	Dim.	Lmm	Im product / beam 3000K F24° W36°	CODE	
8	250	80x80	110	860	860	LT4117.9 ● ● / ##
12	350	80x80	1289	1289	1289	

LED W	mA	Dim.	Lmm	Im product / beam 3000K F27° W46°	CODE	
12	350	80x80	130	1289	1289	LT4118.9 ● ● / ##
18	500	80x80	1575	1575	1575	

IP20 5 UK CA CE

PER CARTONGESSO E LATERIZIO - FOR PLASTERBOARD AND CONCRETE

GU10 LED 230V W	Dim.	Lmm	CODE
1x max 50	80x80	35+lampadina	LT4104 / ##

Accessori Accessories:
LT4102.CC Cassaforma per laterizio Wallbox for brick wall

ACCESSORI OPZIONALI / OPTIONAL ACCESSORIES

CASSAFORMA MINIFRAME 50 GU10 PER LATERIZIO WALLBOX MINIFRAME 50 GU10 FOR BRICK WALL

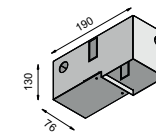

MINIFRAME 50	Dim.	H	CODE
	190X76	130	LT4102.CC

VERSIONI DISPONIBILI / AVAILABLE VERSION

● KELVIN	/ ## FINITURA FINISHING
27 2700K	□ / 01 bianco white
30 3000K	■ / 02 nero black
35 3500K	
40 4000K	

● FASCIO / BEAM

F Flood
W Wide

Per i gradi vedere in tabella - For degrees check the table

/ ## FINITURA PREMIUM | PREMIUM FINISHING

/ 81 oro rosa rose gold
/ 82 bronzo anticato antique bronze
/ 83 ottone brunito spazzolato brushed burnished brass

COMPOSIZIONE CODICE: xxx.x ● ● / ##
HOW TO CREATE THE CODE: F1000.827S / 01

CODE	base code	kelvin	beam	finishing
F1000.8				/ ## — finishing

250 350 500

DRIVERS VEDI | SEE P.452

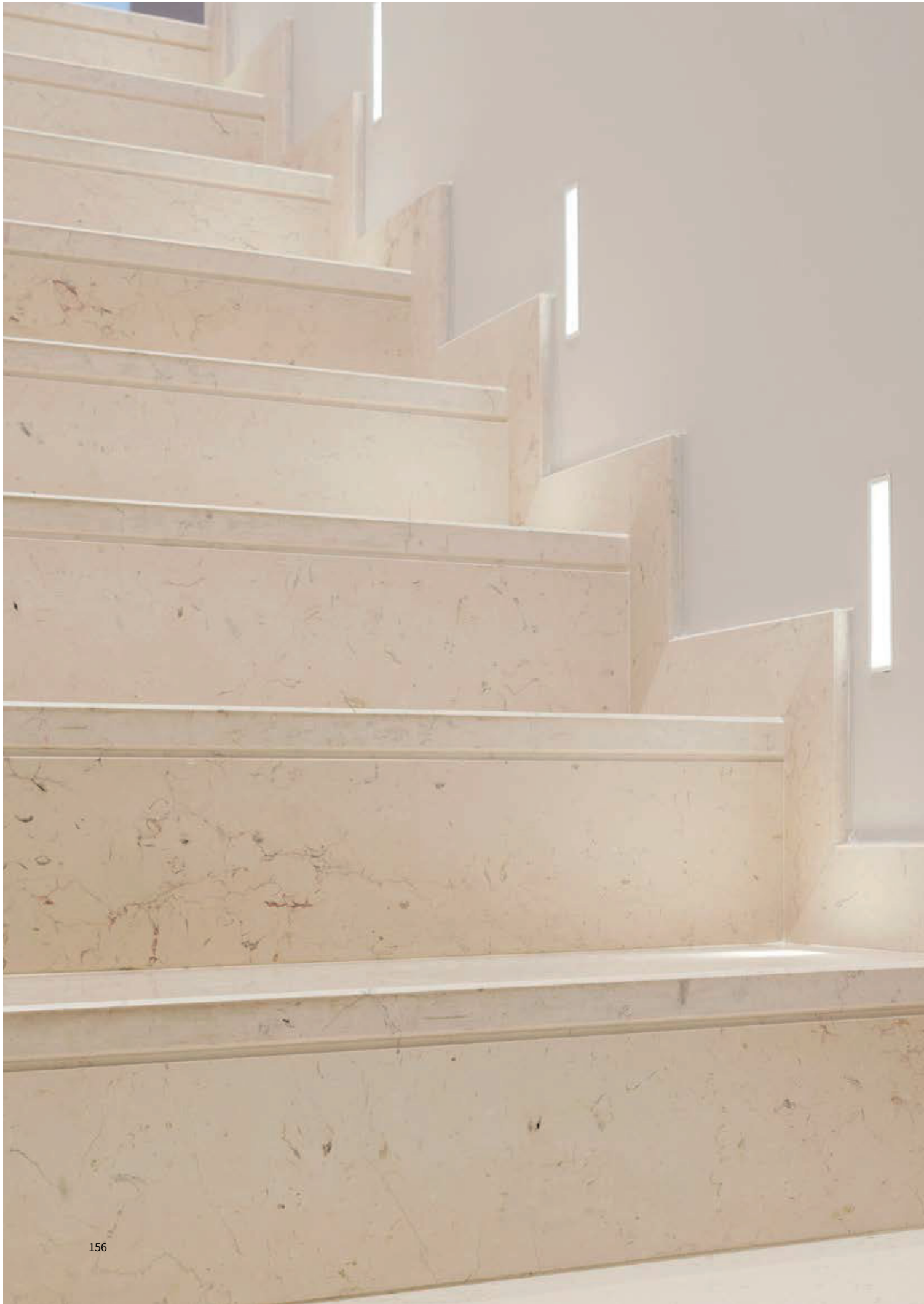

STEP

STEP

Apparecchio da incasso a parete per illuminazione segnapasso direzionata con angolo di 20°, per sorgente LED integrata con alimentazione remota disponibile come accessorio. Corpo e cornice di battuta in metallo verniciato. Installabile anche in pareti e soffitti in calcestruzzo mediante apposita cassaforma in lamiera zincata disponibile come accessorio. Grado di protezione IP20.

Recessed wall luminaire for path lighting with 20 ° angle, for integrated LED source with remote power supply available as accessory. Body and frame in painted metal. It can, also, be installed in concrete or brick ceilings using a special galvanized metal outercasing available as accessory. IP20.



UK CONFORMITY ASSESSMENT E EUROPEAN CERTIFICATION / UK CONFORMITY ASSESSTMENT AND EUROPEAN CERTIFICATION



PRODOTTI COSTRUITI CON MATERIALE RICICLABILE / PRODUCTS MADE OF RECYCLABLE MATERIAL



GARANZIA DI 5 ANNI / 5-YEAR WARRANTY

FISSO / FIXED

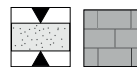

IDONEI PER CARTONGESSO O LATERIZIO / CALCESTRUZZO CON APPOSITA CASSAFORMA OPZIONALE
SUITABLE FOR PLASTERBOARD OR BRICKWALL / CONCRETE WITH THE OPTIONAL BOX

FINITURE STANDARD /STANDARD FINISHINGS FINITURE PREMIUM /PREMIUM FINISHINGS

/01		BIANCO/WHITE	/81		ORO ROSA/ROSE GOLD
/02		NERO/BLACK	/82		BRONZO ANTICATO/ ANTIQU BRONZE
/60		CORTEN	/83		OTTONE BRUNITO SPAZZOLATO/ BRUSHED BURNISHED BRASS

PHOTOMETRIC DATA

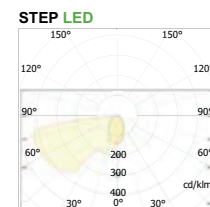

/## FINITURA | FINISHING

	/01 bianco white
	/02 nero black
	/60 corten corten

/## FINITURA PREMIUM | PREMIUM FINISHING

	/81 oro rosa / rose gold
	/82 bronzo anticato antique bronze
	/83 ottone brunito spazzolato brushed burnished brass

FASCIO / BEAM

16°

500 DRIVERS VEDI | SEE P.452

COMPOSIZIONE CODICE: xxx / ##
HOW TO CREATE THE CODE: **F1000 / 01**

CODE
F1000.8 / ## — finishing
base code



STEP 75

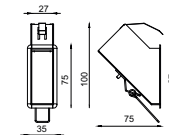
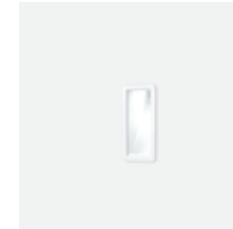

29X69 **500**

LED	W	mA	Dim.	H	Kg	lm product/beam 3000K	CODE
	1,5	500	27x75	67	0,2	16° 252	LT1983BC / ##

Accessori - accessories: LT1992: cassaforma step 75 - Wallbox step 75

STEP 150

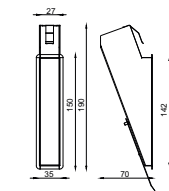

29X144 **500**

LED	W	mA	Dim.	H	Kg	lm product/beam 3000K	CODE
	1,5	500	27x70	142	0,4	16° 252	LT1982BC / ##

Accessori - accessories: LT1991: cassaforma step 150 - Wallbox step 150

STEP 300

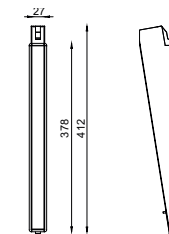

29X372 **500**

LED	W	mA	Dim.	H	Kg	lm product/beam 3000K	CODE
	1,5	500	27x70	370	0,7	16° 252	LT1981BC / ##

Accessori - accessories: LT1990: cassaforma step 300 - Wallbox step 300

ACCESSORI OPZIONALI / OPTIONAL ACCESSORIES

CASSAFORMA WALLBOX

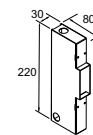

STEP75	Dim. 30x80	H 220	CODE LT1992
--------	---------------	----------	-----------------------

Idonea anche per calcestruzzo. Suitable also for brickwall.

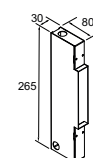

STEP150	Dim. 30x80	H 265	CODE LT1991
---------	---------------	----------	-----------------------

Idonea anche per calcestruzzo. Suitable also for brickwall.

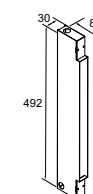

STEP300	Dim. 30x80	H 492	CODE LT1990
---------	---------------	----------	-----------------------

Idonea anche per calcestruzzo. Suitable also for brickwall.

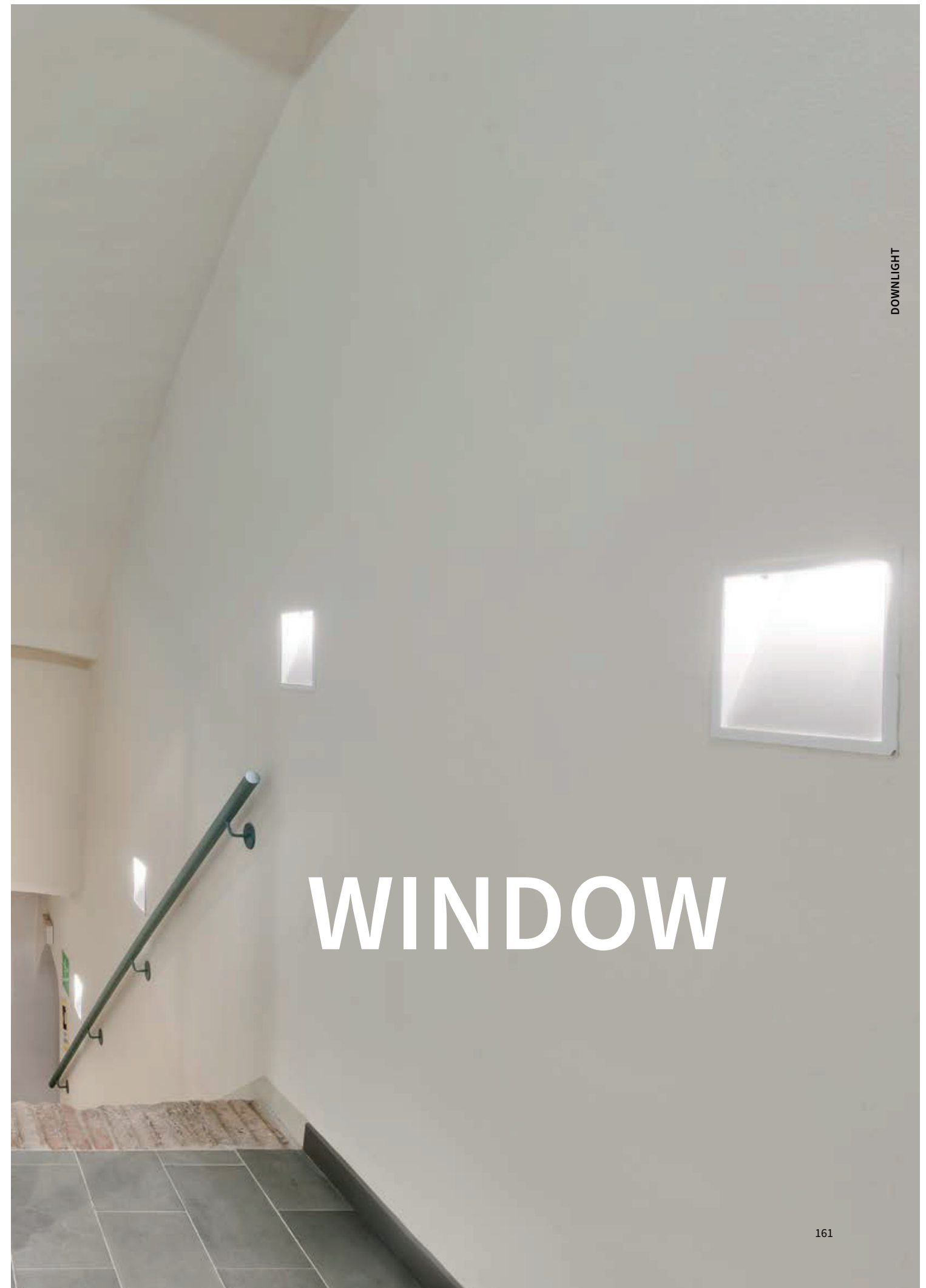
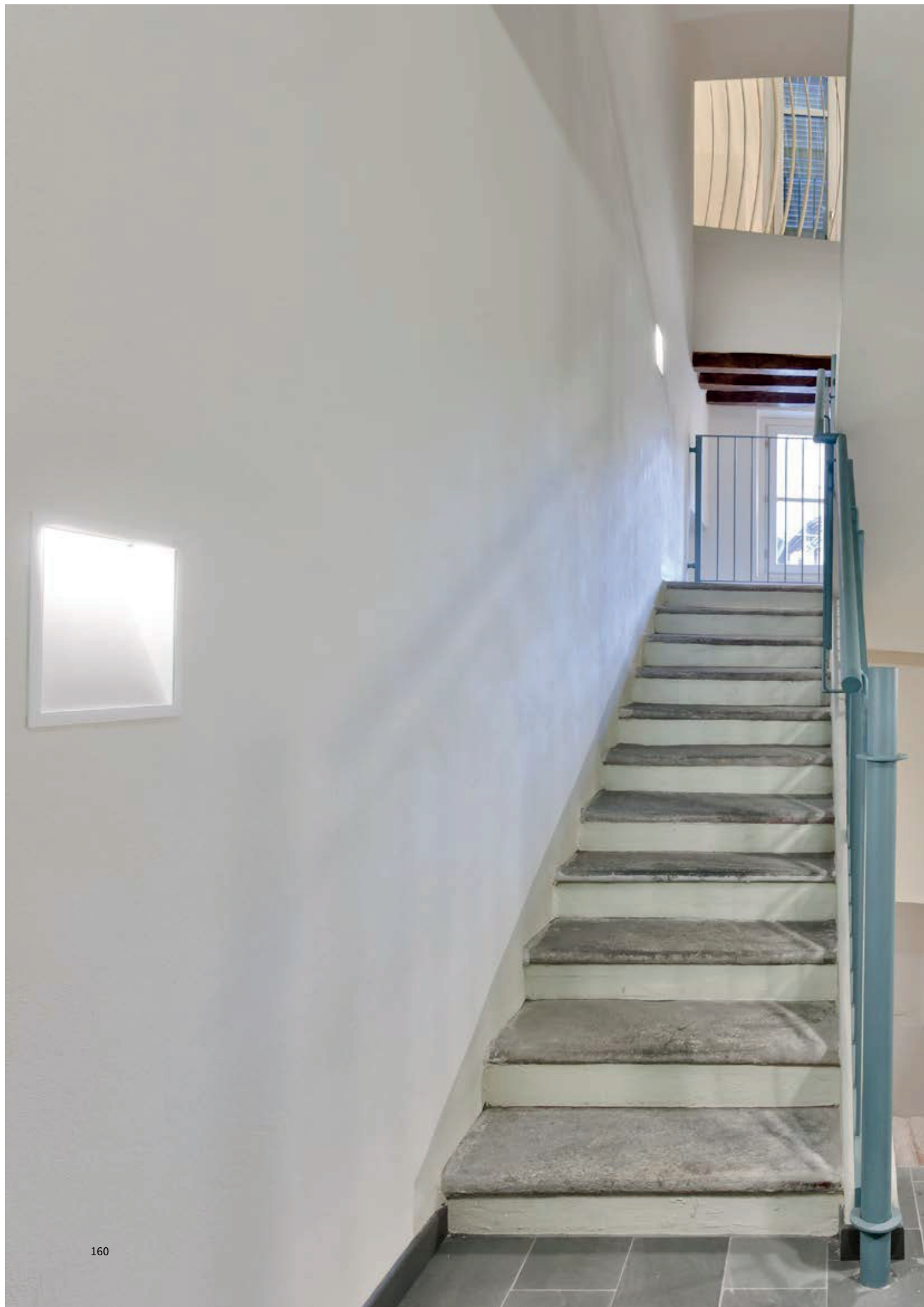

WINDOW

WINDOW

Apparecchio da incasso a parete per illuminazione segnapasso direzionata con angolo di 20°, per sorgente LED integrata con alimentazione remota disponibile come accessorio. Corpo e cornice di battuta in metallo verniciato. Installabile a cartongesso, ma anche in pareti e soffitti in calcestruzzo mediante apposita cassaforma in lamiera zincata disponibile come accessorio solo per la versione Frame. Grado di protezione IP20.

Recessed wall luminaire for path lighting with 20 ° angle, for integrated LED source with remote power supply available as accessory. Body and frame in painted metal. It is suitable for plasterboard, but can, also, be installed in concrete or brick ceilings using a special galvanized metal outercasing available as accessory just for the Frame version. IP20.



UK CONFORMITY ASSESSMENT E EUROPEAN CERTIFICATION / UK CONFORMITY ASSESSTMENT AND EUROPEAN CERTIFICATION



PRODOTTI COSTRUITI CON MATERIALE RICICLABILE / PRODUCTS MADE OF RECYCLABLE MATERIAL



GARANZIA DI 5 ANNI / 5-YEAR WARRANTY



FISSO / FIXED

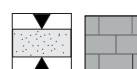

IDONEI PER CARTONGESSO O LATERIZIO / CALCESTRUZZO CON APPOSITA CASSAFORMA OPZIONALE / SUITABLE FOR PLASTERBOARD OR BRICKWALL / CONCRETE WITH THE OPTIONAL BOX

FINITURE / FINISHINGS



01-BIANCO / WHITE

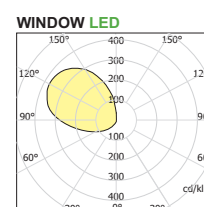

VERSIONI DISPONIBILI / AVAILABLE VERSION

- KELVIN
- 27 2700K
- 30 3000K
- 40 4000K

/## FINITURA | FINISHING

□ /01 bianco | white

350 DRIVERS VEDI | SEE P.452

WINDOW FRAME



WINDOW 224 INCASSO CON BATTUTA RECESSED WITH FRAME



LED W	mA	lm prod	CODE
12,4	350	770	WI001.9 ● / 01

Accessori - accessories: LT1692: 224 - 224

WINDOW 306 INCASSO CON BATTUTA RECESSED WITH FRAME

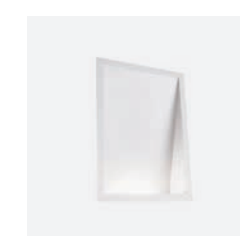

LED W	mA	lm prod	CODE
12,4	350	770	WI001.9 ● / 01

Accessori - accessories: LT1693: 306 - 306

ACCESSORI OPZIONALI / OPTIONAL ACCESSORIES

CASSAFORMA PER LATERIZIO O CALCESTRUZZO WALLBOX FOR BRICKWALL OR CONCRETE

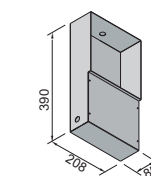

CODE
LT1692

Cassaforma in lamiera zincata da murare in pareti di laterizio o calcestruzzo per l'articolo WINDOW 224. | Galvanized sheet formwork to be installed in brick or concrete walls for Window 224. Solo per versioni con cornice. Only for frame version

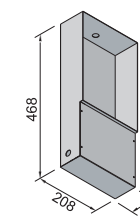

CODE
LT1693

Cassaforma in lamiera zincata da murare in pareti di laterizio o calcestruzzo per l'articolo WINDOW 306. | Galvanized sheet formwork to be installed in brick or concrete walls for window 306. Solo per versioni con cornice. Only for frame version

WINDOW MINIMAL

WINDOW M 224 INCASSO RASATO TRIMLESS RECESSED



LED W	mA	lm prod	CODE
12,4	350	770	WI101.9 ● / 01

Per installazione in pareti di laterizio **non** necessita di cassaforma / For installation in brick walls does not require wallbox

WINDOW M 306 INCASSO RASATO TRIMLESS RECESSED



LED W	mA	lm prod	CODE
12,4	350	770	WI111.9 ● / 01

Per installazione in pareti di laterizio **non** necessita di cassaforma / For installation in brick walls does not require wallbox.

INDOOR - Proiettori | Projectors

CORONA P. 168 **NEW**



IRIDE P. 175

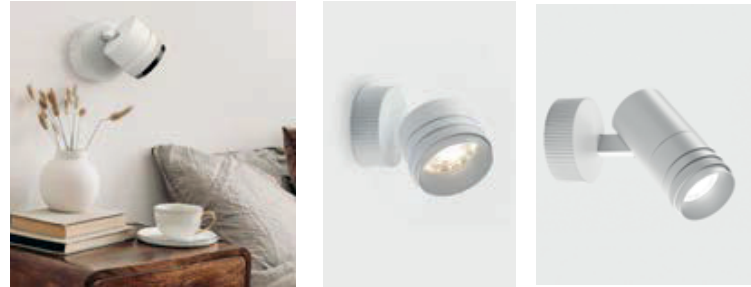

LEVA QUADRA P. 181



FOCUS P. 187 **NEW**



SEMPLICE P. 199



PHAR P. 205



PROIETTORI PER TRACK SYSTEM 230V - TRACK SYSTEM 230V PROJECTORS
vedi/see VOL. 1 - PROFILI - Le Collezioni "Track System"

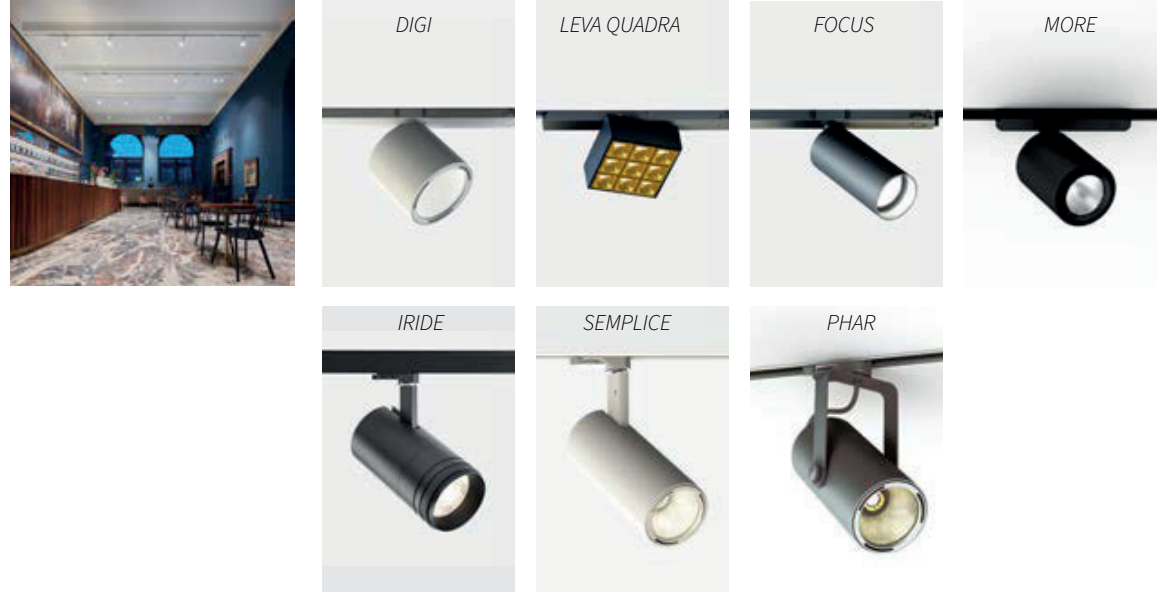



ASSUMPTA EST MARI
IN COLUM



CORONA

PROJECTORS

CORONA

Apparecchio da appoggio o da parete per illuminazione diretta e mirata, studiato per illuminare pareti e soffitti di chiese o particolari architettonici protetti dai beni culturali. Il profilo ha la predisposizione per il passaggio dei cavi elettrici. Due possibilità di installazione, verticale ed orizzontale. Completo di sorgenti LED professionali. Corpo in metallo finitura verniciata. Grado di protezione IP40.

Free standing luminaire for direct and targeted lighting, designed to illuminate walls and ceilings of churches or architectural details protected by cultural heritage. The profile has the predisposition for the passage of electrical cables. Two installation possibilities, vertical and horizontal. Complete with professional LED sources. Painted finish metal body. Degree of protection IP40.

Installazione da appoggio orizzontale qui rappresentato in versione a luce diretta ed indiretta / Installation from horizontal support represented here in direct and indirect light version

Installazione a parete verticale, qui rappresentato in versione a luce diretta e indiretta / Vertical wall installation, represented here in direct and indirect light version.



UK CONFORMITY ASSESSMENT E EUROPEAN CERTIFICATION / UK CONFORMITY ASSESSMENT AND EUROPEAN CERTIFICATION



PRODOTTI COSTRUITI CON MATERIALE RICICLABILE / PRODUCTS MADE OF RECYCLABLE MATERIAL



GARANZIA DI 5 ANNI / 5-YEAR WARRANTY

FINITURE STANDARD / STANDARD FINISHINGS

- /01 BIANCO/WHITE
- /02 NERO/BLACK
- /49 BRONZO/BRONZE

TOGLIERE INDIRETTA

CORONA DA APPOGGIO / FREE STANDING

LUCE DIRETTA DIRECT LIGHT

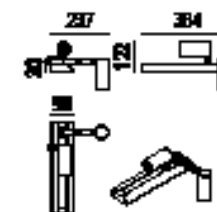

CORONA 2SPOTS 55

LED W	mA	ø	lm product/beam 3000K			CODE
			S15°	F27°	W46°	
2x12	350	55	2570	2570	2578	CR001.9 ●●● /##
2x18	500	55	3150	3150	3158	CR002.9 ●●● /##

CORONA 2SPOTS 90

LED W	ø	lm product/beam 3000K			CODE
		S15°	F24°	W38°	
2 X 24,3	90	4936	4712	4860	CR004.9 ●●● /##
2 X 32	90	6012	5770	5910	CR005.9 ●●● /##

CORONA DA PARETE / WALL MOUNTED

LUCE DIRETTA DIRECT LIGHT

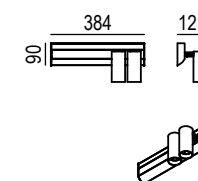

CORONA 2SPOTS 55

LED W	mA	ø	lm product/beam 3000K			CODE
			S15°	F27°	W46°	
2x12	350	55	2570	2570	2578	CR003.9 ●●● /##
2x18	500	55	3150	3150	3158	CR006.9 ●●● /##

CORONA 2SPOTS 90

LED W	ø	lm product/beam 3000K			CODE
		S15°	F24°	W38°	
2 X 24,3	90	4936	4712	4860	CR007.9 ●●● /##
2 X 32	90	6012	5770	5910	CR008.9 ●●● /##

VERSIONI DISPONIBILI/AVAILABLE VERSION

● KELVIN

- 27 2700K
- 30 3000K
- 35 3500K
- 40 4000K

● FASCIO/BEAM

- S Spot
- F Flood
- W Wide

● DIMMABLE (OPTIONAL)

- D Dali Touch & Dimm

FINITURA/FINISHING

- /01 bianco | white
- /02 nero | black
- /49 bronzo | bronze

Per i gradi vedere in tabella - For degree check the table



CORONA SISTEMA



PROFILI - PROFILE

PROFILO A RETTILINEO / STRAIGHT A PROFILE

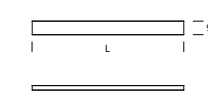

Lmm
1000
2000
3000

CODE
LB340 /##
LB341 /##
LB342 /##

COPPIA DI TESTATE PER PROFILO A / COUPLE OF CLOSURE HEADS A PROFILE

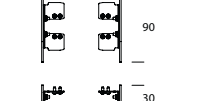

CODE
LB422 /##

PROFILO B RETTILINEO LUCE INDIRECTA / STRAIGHT B PROFILE INDIRECT LIGHT



1000
2000
3000

CODE
MFH00.1000/01
MFH00.2000/01
MFH00.3000/01
MFH00.misura/01

COPPIA DI TESTATE PER PROFILO B / COUPLE OF CLOSURE HEADS B PROFILE



CODE
MFH00C/01

DIFFUSORE IN POLICARBONATO OPALINO / OPALINE POLYCARBONATE DIFFUSER



1000
2000
3000

MF00P.1000
MF00P.2000
MF00P.3000
MF00P.misura

DIFFUSORE PERIMETRALE PROFILO A / PERIMETRIC DIFFUSER A PROFILE



Lmm
1000
2000
3000

CODE
LB431
LB432
LB433



COVER PERIMETRALE VERNICIATO (CIECO) PROFILO A / PERIMETRIC SLOT CLOSURE ELEMENT A PROFILE



Lmm
1000

CODE
LB431 /##

DIFFUSORE INDIRECTO LINEARE PROFILO A / INDIRECT LINEAR DIFFUSER A PROFILE

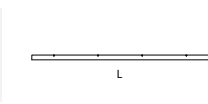

Lmm
1000

CODE
LB447

per LB340 - LB341 - LB342 | for LB340 - LB341 - LB342 | por LB340 - LB341 - LB342



SEZIONE PROFILO / PROFILE SECTION

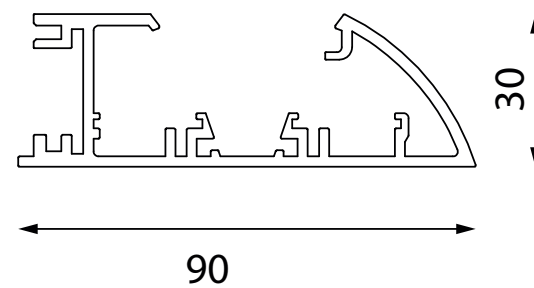

/## FINITURA/FINISHING

- /01 bianco/white
- /02 nero/black
- /49 bronzo/bronze

/## FINITURA PREMIUM /PREMIUM FINISHING

- /81 oro rosa shine/shine pink gold
- /82 bronzo anticato /antique bronze
- /83 ottone brunito spazzolato/brushed brushed brass

LINEA DI LUCE PER LUCE PERIMETRALE LED LINE FOR PERIMETRIC EMISSION



LINEADI LUCE - LED LINE									
W/m	Led/m	K	lm/m	lm/W	CRI	IP	Lmm	CODE	
22	168	2700	3015	139	80	20	5000	ST22.27.5	
22	168	3000	3015	139	80	20	5000	ST22.30.5	
22	168	4000	3270	139	80	20	5000	ST22.40.5	

LBS SPOT SPOT PROJECTOR

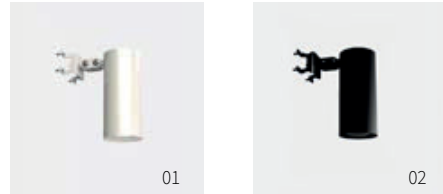
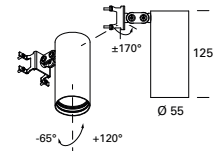

LED 48V	3000K	lm product/beam					CODE
W	Ø mm	Hmm	S15°	F27°	W46°		
12	55	125	1285	1285	1289	LB102.9 ●●●/###	
18	55	125	1575	1575	1579	LB103.9 ●●●/###	

Installabile su tutti i prodotti a luce perimetrale | suitable to fit in perimetric emission fittings
Accessori - Accessories L055#A: Lente con anello - lens with ring

PROIETTORI - PROJECTORS
SPOT FOCUS 55

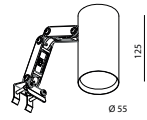
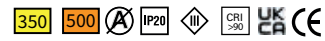

LED	mA		A	Ø	H	lm product/beam 3000K			CODE
W						S15°	F27°	W46°	
12	350			55	125	1285	1285	1289	GU003.9 ●●●/###
18	500			55	125	1575	1579		

Accessori - Accessories: L055S#: Anello ø55 + lente / lens with ring ø55

SPOT FOCUS 90

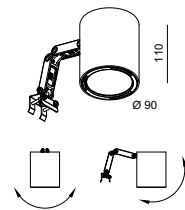
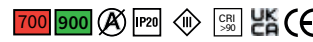

LED	mA		A	Ø	H	Kg	lm product/beam 3000K			CODE
W							S15°	F24°	W38°	
24,3	700			90	110	0,94	2468	2356	2430	GU005.9 ●●●/###
32	900			90	110	0,94	3006	2885	2955	GU006.9 ●●●/###

Accessori - Accessories: L085S#: Anello ø85 + lente / lens with ring ø85

LENTI CON ANELLO / LENSES WITH RING



	Kg	Ø	CODE	Ø	CODE
LENTE SATINATA / SATINED LENS	0,01	55	L055S.A /##	85	L085S.A /##
LENTE ELISSOIDALE / ELIPSOID LENS	0,01	55	L055E.A /##	85	L085E.A /##
LENTE ASIMMETRICA / ASYMMETRIC LENS	0,01	55	L055A.A /##	85	L085A.A /##
FILTRO NIDO D'APE / HONEY COMB LOUVER	0,01	55	L055R.A /##	85	L085R.A /##

"PROFILO B" PER LUCE INDIRETTA
"B PROFILE" FOR INDIRECT LIGHT

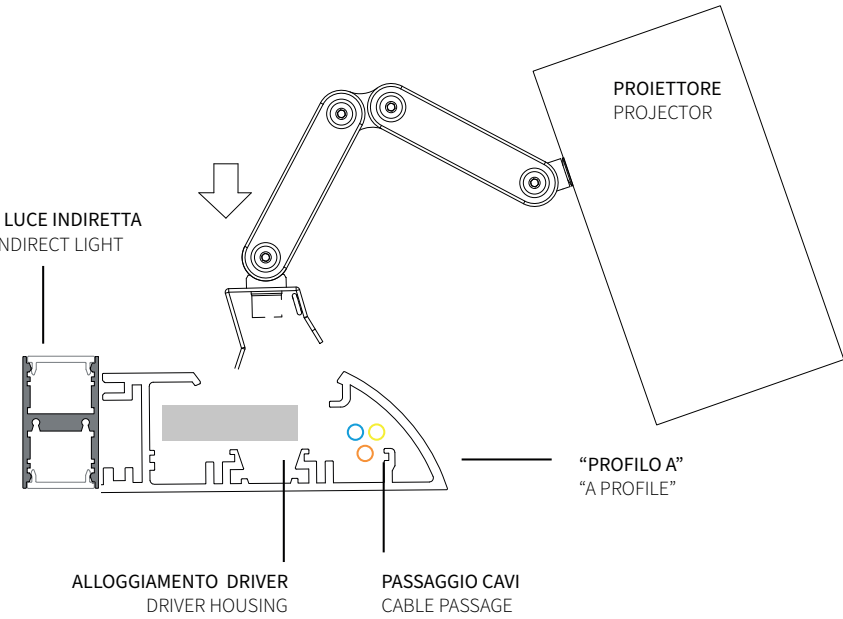

VERSIONI DISPONIBILI/AVAILABLE VERSION

- **KELVIN**
- 27 2700K
- 30 3000K
- 40 4000K
- **FASCIO/BEAM**
- S Spot
- F Flood
- W Wide

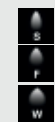

Per i gradi vedere in tabella - For degree check the table

- **DIMMABLE**
- D Dali Touch & Dimm

- /## **FINITURA/FINISHING**
- /01 bianco/white
- /02 nero/black

- /## **FINITURA PREMIUM /PREMIUM FINISHING**
- /81 oro rosa shine/shine pink gold
- /82 bronzo/ bronze
- /83 ottone spazzolato/ brushed brass



DRIVERS VEDI | SEE P. 452

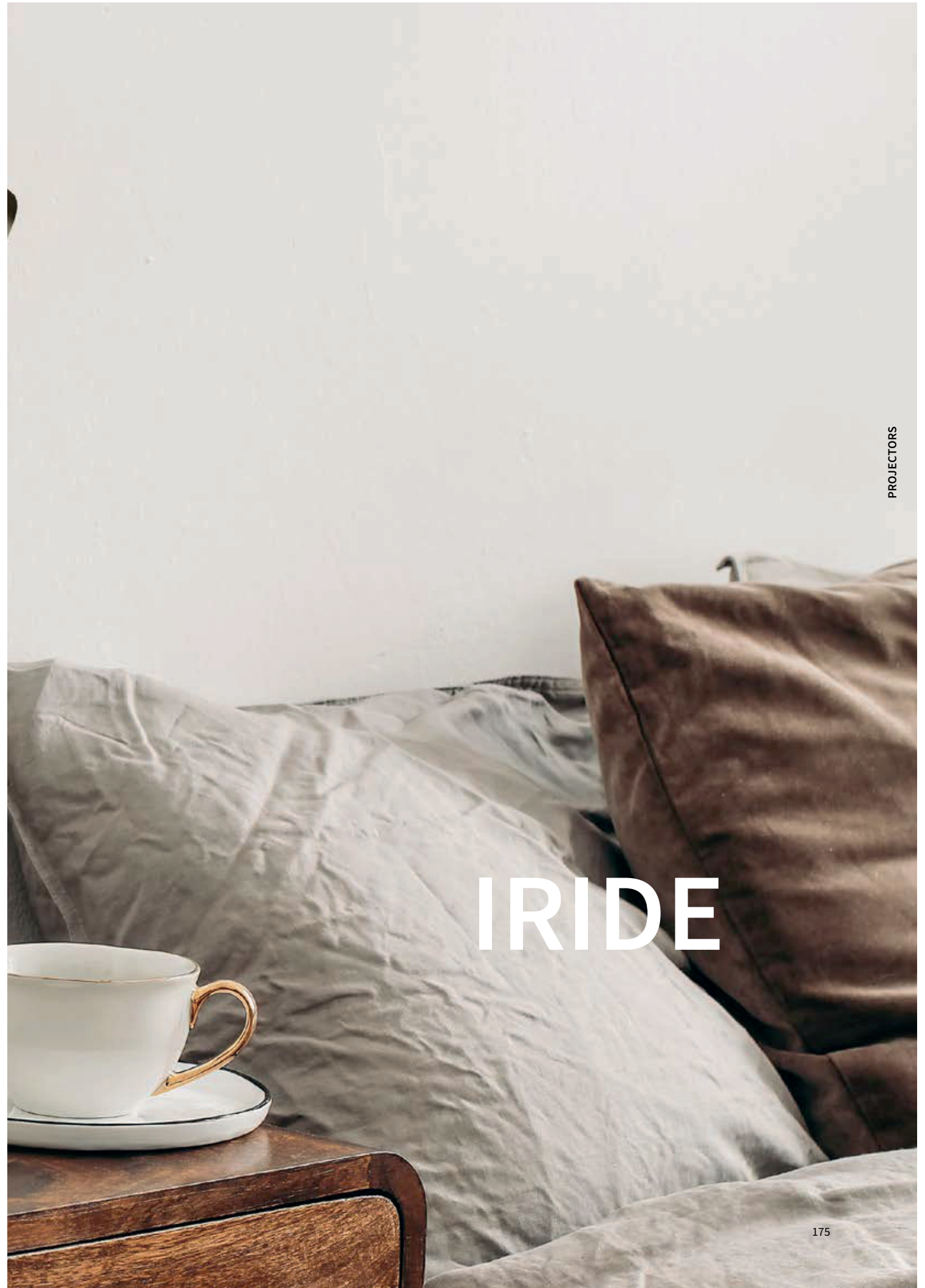

IRIDE



IRIDE

mario cucinella design

Collezione di proiettori orientabili firmati Mario Cucinella. Con sorgenti LED integrate. Possibilità di montaggio a soffitto o su binari elettrificati, trifase o in bassa tensione 48V tipo binario Multi system Stucchi. Iride è costituita da un corpo in pressofusione di alluminio verniciato e da un anello intercambiabile cromato, presente in svariate tipologie e forme create per direzionare il fascio di luce in modi differenti. Gruppi ottici completi di led ad alta resa cromatica (CRI>90), lente, housing antiabbagliamento e driver elettronico. Corpo ottico orientabile nelle versione binario, con possibilità di orientamento 0-90° rispetto all'asse orizzontale e 355° rispetto all'asse verticale, la versione a basetta offre un'ulteriore possibilità di rotazione. Ottiche spot, flood e wide. Grado di protezione IP20.

New collection of adjustable projectors by Mario Cucinella featuring integrated LED sources, ceiling or track mounted (Stucchi tracks) both for mains voltage or 48V. Iride consists of a body in painted die-cast aluminum and an interchangeable ring – in white, black or chrome finishing – for customization. Optical groups complete with high color rendering LEDs (CRI > 90), lens, anti-glare housing and electronic driver. Adjustable optical body in the track version, with the 0-90° orientation on the horizontal axis and 355° on the vertical axis; the surface mounted version offers an additional rotation possibility. Spot, flood and wide optics. IP20.

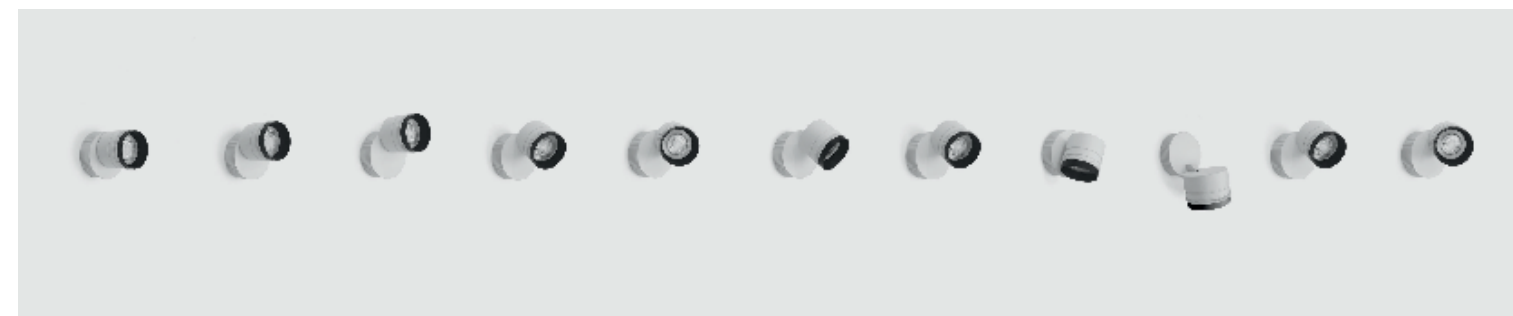

UK CONFORMITY ASSESSMENT E EUROPEAN CERTIFICATION / UK CONFORMITY ASSESSMENT AND EUROPEAN CERTIFICATION



PRODOTTI COSTRUITI CON MATERIALE RICICLABILE / PRODUCTS MADE OF RECYCLABLE MATERIAL



GARANZIA DI 5 ANNI / 5-YEAR WARRANTY



ORIENTABILE / ADJUSTABLE



DIAM. 86 MM / 114 MM

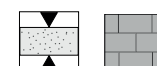

IDONEI PER CARTONGESSO OR LATERIZIO / CALCESTRUZZO a seconda dei modelli e degli accessori. SUITABLE FOR PLASTERBOARD OR BRICKWALL / CONCRETE it depends on the model and its accessories.

KELVIN

27		2700°K
30		3000°K
35		3500°K
40		4000°K

FASCIO/BEAM

S		SPOT
F		FLOOD
W		WIDE

FINITURE STANDARD / STANDARD FINISHINGS

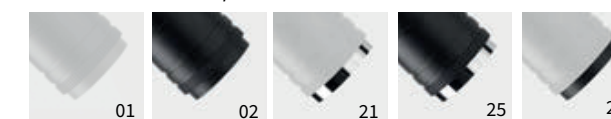

/## FINITURA/FINISHING

- /01 corpo bianco anello bianco | white body and ring
- /02 corpo nero anello nero | black body and ring
- /21 corpo bianco, anello cromo | white body, chrome ring
- /25 corpo nero, anello cromo | black body, chrome ring
- /28 corpo bianco, anello nero | white body, black ring

FINITURE PREMIUM / PREMIUM FINISHINGS

- /81 ORO ROSA/ROSE GOLD
- /82 BRONZO ANTICATO/ANTIQUE BRONZE
- /83 OTTONE BRUNITO SPAZZOLATO/ BRUSHED BURNISHED BRASS

CURVE FOTOMETRICHE/PHOTOMETRIC DATA

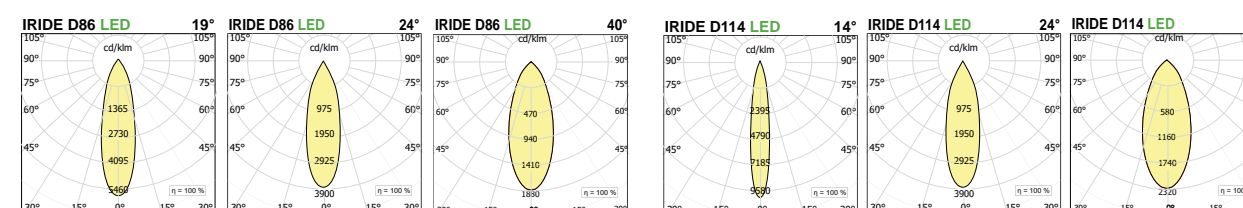

IRIDE

BASE



altre versioni / more versions:

MINITRACK 24/48V

vedi catalogo "Profili Le Collezioni" | see catalogue "Profili Le Collezioni"

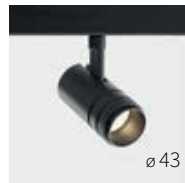

TRACK 230V

vedi catalogo "Profili Le Collezioni" | see catalogue "Profili Le Collezioni"



INCASSO | DOWNLIGHT

vedi capitolo "Downlight" | see chapter "Downlight"



IRIDE BASETTA - BASE

IRIDE BASE 86S



LED W	ø	lm product/beam 3000K			CODE
		S19°	F24°	W40°	
18	86	1772	1832	1586	IR00.9 ●●●/##
26	86	2193	2252	2008	IR01.9 ●●●/##

IRIDE BASE 114S



LED W	ø	lm product/beam 3000K			CODE
		S14°	F24°	W36°	
26	114	2118	2531	2108	IR02.9 ●●●/##
34	114	2476	2942	2596	IR03.9 ●●●/##

IRIDE BASE 86L

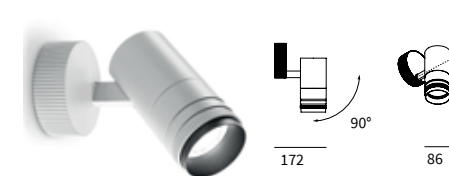

LED W	ø	lm product/beam 3000K			CODE
		S19°	F24°	W40°	
18	86	1772	1832	1586	IR04.9 ●●●/##
26	86	2193	2252	2008	IR05.9 ●●●/##

IRIDE BASE 114L

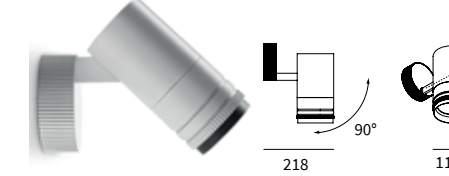

LED W	ø	lm product/beam 3000K			CODE
		S14°	F24°	W36°	
26	114	2118	2531	2108	IR06.9 ●●●/##
34	114	2476	2942	2596	IR07.9 ●●●/##

ACCESSORI / ACCESSORIES

LENTE OPZIONALE / OPTIONAL LENS

	ø	Kg	CODE
FILTRO NIDO D'APE/ HONEY COMB LOUVER	86	0,01	L086R
	114	0,01	L114R

VERSIONI DISPONIBILI/AVAILABLE VERSION

● KELVIN

- 27 2700K
- 30 3000K
- 35 3500K
- 40 4000K

● FASCIO/BEAM

- S Spot
- F Flood
- W Wide

● DIMMABLE (OPTIONAL)

- D Dali

COMPOSIZIONE CODICE: xxx.x●●●/##

HOW TO CREATE THE CODE: F1000.827SD /01

CODE
F1000.8 | ● | ● | ● | /##shing
base code | kelvin | beam | dimmable

/## FINITURA/FINISHING



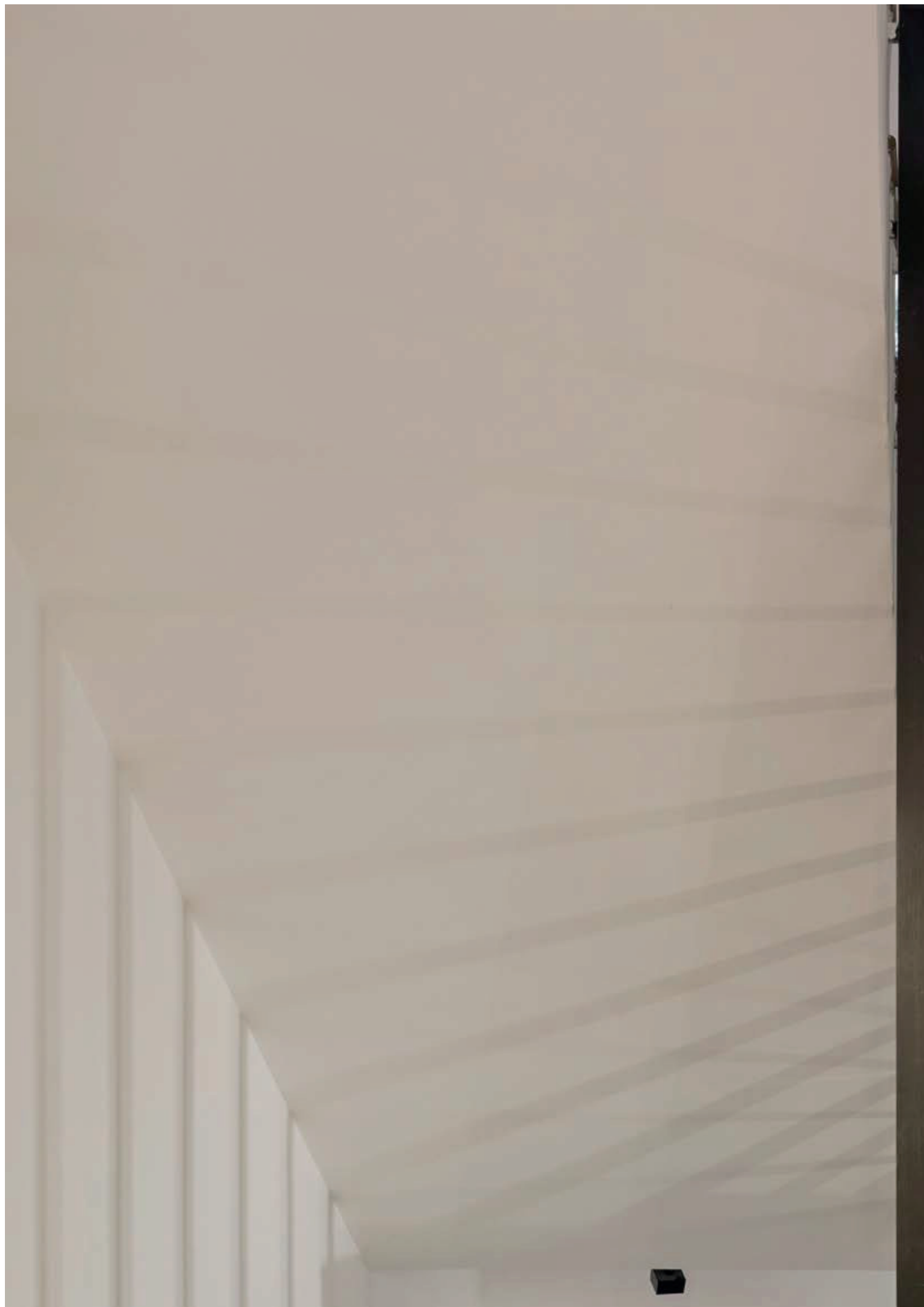

LEVA QUADRA

LEVA QUADRA

PROIETTORE DA INCASSO - PROJECTOR TO RECESS



PROIETTORI CON BASETTA - PROJECTOR WITH BASE



altre versioni / more versions:

INCASSO | DOWNLIGHT

vedi capitolo "Downlight"
see chapter "Downlight"

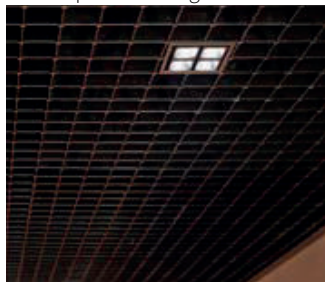

MINITRACK 24/48V

vedi catalogo "Profili Le Collezioni"
see catalogue "Profili Le Collezioni"



TRACK 230V

vedi catalogo "Profili Le Collezioni"
see catalogue "Profili Le Collezioni"



Collezione di proiettori fissi e orientabili per sorgenti LED integrate. Possibilità di montaggio a incasso, con basetta od a soffitto. Corpo apparecchio in fusione di alluminio verniciato. Gruppi ottici antiabbagliamento completi di led chip on board (CRI>90) e lenti. Ottiche spot, flood, wideflood UGR<16. Da completare con alimentatori elettronici remoti per le versioni ad incasso. Grado di protezione IP20/IP40.

Collection of fixed and adjustable projectors, recessed, surface or ceiling mounted, for integrated LED sources. Luminaire body in painted aluminum casting. Anti-glare optical groups complete with LED chip on board (CRI> 90) and lenses. Spot, flood, wideflood UGR <19 optics. To be completed with remote electronic drivers for the recessed versions. IP20/IP40.



UK CONFORMITY ASSESSMENT E EUROPEAN CERTIFICATION / UK CONFORMITY ASSESSMENT AND EUROPEAN CERTIFICATION



PRODOTTI COSTRUITI CON MATERIALE RICICLABILE / PRODUCTS MADE OF RECYCLABLE MATERIAL



GARANZIA DI 5 ANNI / 5-YEAR WARRANTY



ORIENTABILE / ADJUSTABLE

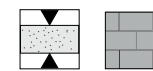

IDONEI PER CARTONGESSO OR LATERIZIO / CALCESTRUZZO a seconda dei modelli e degli accessori. SUITABLE FOR PLASTERBOARD OR BRICKWALL / CONCRETE it depends on the model and its accessories.

KELVIN

27		2700°K
30		3000°K
35		3500°K
40		4000°K

FASCIO/BEAM

S		SPOT 20°
F		FLOOD 32°
W		WIDE 50°

FINITURE STANDARD /STANDARD FINISHINGS

/01		TELAIO BIANCO OTTICA NERA/ WHITE FRAME BLACK OPTIC
/02		TELAIO NERO OTTICA NERA/ BLACK FRAME BLACK OPTIC
/41		TELAIO BIANCO OTTICA BIANCA/ WHITE FRAME WHITE OPTIC
/42		TELAIO NERO OTTICA ORO/ BLACK FRAME GOLD OPTIC

TW



Tunable White 2700 – 5000°K
La tecnologia Tunable White consente di controllare la temperatura di colore delle sorgenti luminose permettendo di scegliere quella più adatta tra luce bianca calda e fredda. / Tunable White technology allows you to control the color temperature of light sources allowing you to choose the most suitable between warm and cold white light.

FINITURE PREMIUM /PREMIUM FINISHINGS

81-ORO ROSA/ PINK GOLD	82-BRONZO ANTICA- TO/ANTIQUE BRONZE	83-OTTONE BRUNITO SPAZZOLATO/BRUSHED BURNISHED BRASS

CURVE FOTOMETRICHE/PHOTOMETRIC DATA

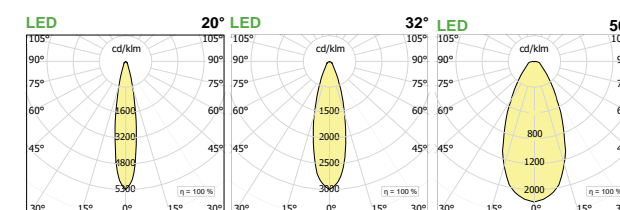



LEVA QUADRA PROIETTORE DA INCASSO - PROJECTOR TO RECESS

Q4 INCASSO Q4 RECESSED SOLO PER CARTONGESSO - ONLY FOR PLASTERBOARD 80 mm

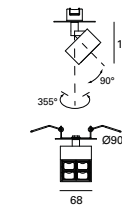

LED W	mA	Dim.	H	Kg	lm product/beam 3000K			CODE
					S20°	F32°	W50°	
8,8	700	68x68	100	0,30	800	745	662	LV410.9 ●● /##

700

Q9 INCASSO Q9 RECESSED SOLO PER CARTONGESSO - ONLY FOR PLASTERBOARD 80 mm

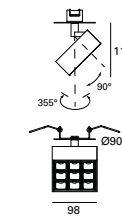

LED W	mA	Dim.	H	Kg	lm product/beam 3000K			CODE
					S20°	F32°	W50°	
19,8	700	98x98	115	0,90	1800	1676	1490	LV411.9 ●● /##

700

LEVA QUADRA PROIETTORI CON BASE - PROJECTOR WITH BASE

Q4 SOFFITTO ORIENTABILE Q4 CEILING - MOUNTED ADJUSTABLE

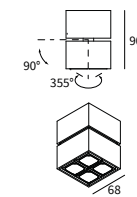

LED W	mA	Dim.	H	Kg	lm product/beam 3000K			CODE
					S20°	F32°	W50°	
8,8	700	68x68	90	0,60	800	745	662	LV312.9 ●● /##

700

Q9 SOFFITTO ORIENTABILE Q9 CEILING - MOUNTED ADJUSTABLE

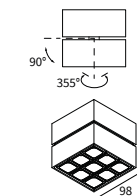

LED W	Dim.	H	Kg	lm product/beam 3000K			CODE
				S20°	F32°	W50°	
19,8	98x98	90	0,90	1800	1676	1490	LV316.9 ●● /##

Note: Nella versione Tunable White l'alimentatore è da porre remoto | For the version Tunable White, power supply to be installed remotely.

LEVA QUADRA SOFFITTO - CEILING

Q9 SOFFITTO Q9 CEILING - MOUNTED

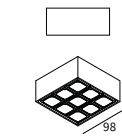

LED W	Dim.	H	Kg	lm product/beam 3000K			CODE
				S20°	F32°	W50°	
19,8	98x98	43	0,60	1800	1676	1490	LV333.9 ●● /##

700

VERSIONI DISPONIBILI/AVAILABLE VERSION

- **KELVIN**
- 27 2700K
- 30 3000K
- 35 3500K
- 40 4000K
- TW Tunable White Dali

Note: Gli apparecchi con temperatura di colore variabile (Tunable White) vengono forniti comprensivi di alimentatore DALI | The devices with variable color temperature (Tunable White) are supplied with integrated DALI power supply.

● FASCIO/BEAM

- Spot
- Flood
- Wide

Per i gradi vedere in tabella - For degree check the table

COMPOSIZIONE CODICE: xxx.x ●● /##

HOW TO CREATE THE CODE: **F1000.827S/01**

base code | kelvin | beam | /## finishing

/## FINITURA/FINISHING

- /01 telaio bianco, ottica nera | white frame, black optic
- /02 telaio nero, ottica nera | black frame, black optic
- /41 telaio bianco, ottica bianca | white frame, white optic
- /42 telaio nero, ottica oro | black frame, gold optic

700 DRIVERS VEDI | SEE P. 452



FOCUS

FOCUS

FOCUS CON BASETTA ALIMENTATORE INTEGRATO - FOCUS WITH BASE AND DRIVER INCLUDED



FOCUS CON BASETTA - PROJECTORS WITH BASE



FOCUS MAGNETE - MAGNETIC PROJECTORS



FOCUS CON PIATTELLO - PLATE PROJECTORS



Per cartongesso |
for plasterboard

FOCUS CON BICCHIERE - CUP PROJECTORS



Per cartongesso |
for plasterboard

altre versioni / more versions:

MINITRACK 24/48V
vedi sezione "Minitrack"
see section "Minitrack"



TRACK 230V
vedi catalogo "Profili Le Collezioni" - Track System
see catalogue "Profili Le Collezioni" - Track system



Collezione di proiettori di dimensioni estremamente ridotte. Le versioni COB LED sono complete di sorgente ad alte prestazioni da completare con driver remoto (escluse versione con basetta rettangolare del Focus Ø55 equipaggiate con driver a bordo). Le versioni per GU10 sono da completare con lampadina (max 50W). La gamma si articola in tre tipi di apparecchi con potenze di 5,7W per il Ø26mm, 8w per il Ø36mm e 12,7W o 18,5W per il Ø55 a seconda dei modelli. Varie le possibilità di installazione: su superfici metalliche ferritiche nella versione magnetica; parete o soffitto con basetta tonda (driver remoto) a soffitto in cartongesso in versione con cornice a filo o arretrato con driver remoto, trasformabile in versione trimless mediante l'installazione di un accessorio.

Extremely small projector collection. The COB LED versions include high-performance light source to be completed with remote driver (excluding Focus Ø55, with rectangular canopy, equipped with on-board driver). GU10 versions to be completed with light bulb (max 50W). The range is divided into three types of fixtures with powers of 5.7W for the Ø26mm, 8w for the Ø36mm and 12.7W or 18.5W for the Ø55 depending on the model. Various installation possibilities: on ferritic metal surfaces in the magnetic version; wall or ceiling with round base (remote driver) on plasterboard ceiling in flush-mounted version or deep recessed with remote driver, transformable into trimless version using the available accessory.

UK CONFORMITY ASSESSMENT E EUROPEAN CERTIFICATION / UK CONFORMITY ASSESMENT AND EUROPEAN CERTIFICATION

PRODOTTI COSTRUITI CON MATERIALE RICICLABILE / PRODUCTS MADE OF RECYCLABLE MATERIAL

GARANZIA DI 5 ANNI / 5-YEAR WARRANTY

ORIENTABILE / ADJUSTABLE

IDONEI PER CARTONGESSO OR LATERIZIO / CALCESTRUZZO a seconda dei modelli e degli accessori. SUITABLE FOR PLASTERBOARD OR BRICKWALL / CONCRETE it depends on the model and its accessories.

VERSIONI CON SORGENTE LED GU10 DISPONIBILI / GU10 LIGHT SOURCE VERSION AVAILABLE FINITURE STANDARD / STANDARD FINISHINGS

KELVIN	FASCIO/BEAM	/01	BIANCO/WHITE
27 2700°K	SPOT	/02	NERO/BLACK
30 3000°K	FLOOD	/49	BRONZO/BRONZE
35 3500°K	WIDE	FINITURE PREMIUM / PREMIUM FINISHINGS	
40 4000°K		/81	ORO ROSA/ROSE GOLD
		/82	BRONZO ANTICATO/ANTIQUE BRONZE
		/83	OTTONE BRUNITO SPAZZOLATO/BRUSHED BURNISHED BRASS

CURVE FOTOMETRICHE/PHOTOMETRIC DATA

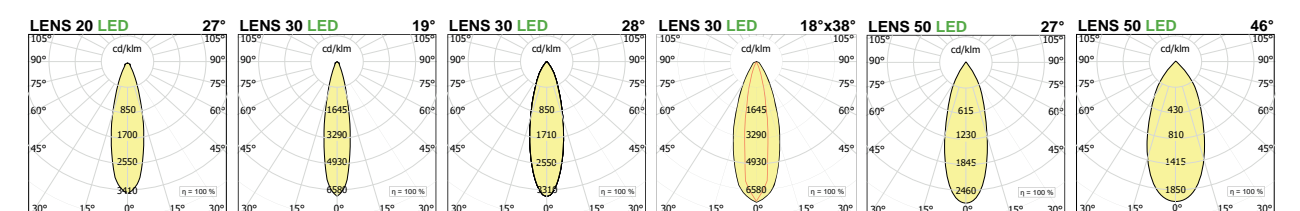

FOCUS 55

Facile da installare - Pronto all'uso

Easy to install - Ready to use



Alimentazione integrata | Driver included



DRIVER INCLUDED

PROJECTORS

FOCUS 55 DRIVER INTEGRATO

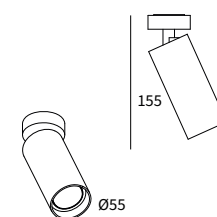

LED W	mA	ø	H	lm product/beam 3000K S15°	F27°	W46°	CODE
12	350	55	155	1285	1285	1289	FS014.9 ● ● /##
18	500	55	155	1575	1575	1579	FS015.9 ● ● /##

Accessori - accessories: L055#.A: Anello ø55 + lente /Lens with ring ø55

ACCESSORI / ACCESSORIES

LENTI CON ANELLO / LENSES WITH RING

	ø	Kg	CODE	/##
● LENTE SATINATA / SATINED LENS	55	0,01	L055S.A	
● LENTE ELISSOIDALE / ELIPSOID LENS	55	0,01	L055E.A	/01
● LENTE ASIMMETRICA / ASYMMETRIC LENS	55	0,01	L055A.A	/02
● FILTRO NIDO D'APE / HONEY COMB LOUVER	55	0,01	L055R.A	

VERSIONI DISPONIBILI / AVAILABLE VERSION

- **KELVIN**
 - 27 2700K
 - 30 3000K
 - 35 3500K
 - 40 4000K
- **FASCIO / BEAM**
 - S Spot
 - F Flood
 - W Wide

Per i gradi vedere in tabella - For degree check the table

/## FINITURA / FINISHING

- /01 bianco | white
- /02 nero | black
- /49 bronzo | bronze

/## FINITURA PREMIUM / PREMIUM FINISHING

- /81 oro rosa / rose gold
- /82 bronzo antico / antique bronze
- /83 ottone brunito spazzolato / brushed burnished brass

COMPOSIZIONE CODICE: xxx.x ● ● /##

HOW TO CREATE THE CODE: F1000.827S /01

CODE

F1000.8 | ● | ● | - /## finishing

base code | kelvin | beam

FOCUS MAGNETE | MAGNETIC VERSION



FOCUS M26



LED W	mA	ø	H	Im product/beam 3000K	CODE
5,7	500	26	85	F27°	FS001.9 ● ● F /##

● disponibile solo fascio F available only F beam

Note: Attenzione uscita dei cavi laterale. Side cable exit. Accessori - accessories: FSA02.26: piastra ancoraggio magneti M26 - L026#.A: Anello ø26 + lente /Lens with ring ø26

FOCUS M36



LED W	mA	ø	H	Im product/beam 3000K	CODE
8	700	36	92	S19° F28° Z18°x38°	FS002.9 ● ● F /##

Note: Attenzione uscita dei cavi laterale. Side cable exit. Accessori - accessories: FSA02.36: piastra ancoraggio magneti M36 - L036#.A: Anello ø36 + lente /Lens with ring ø36

FOCUS M55

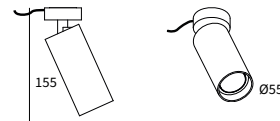

LED W	mA	ø	H	Im product/beam 3000K	CODE
12	350	55	155	S15° F27° W46°	FS003.9 ● ● F /##
18	500	55	155	1285 1285 1289	

GUI10LED W	ø	H	CODE
50	55	155	FS005/##

Note: Attenzione uscita dei cavi laterale. Side cable exit. Accessori - accessories: FSA02.55: piastra ancoraggio magneti M55 / magnet anchor plate- L055#.A: Anello ø55 + lente /Lens with ring ø55

VERSIONI DISPONIBILI/AVAILABLE VERSION

- KELVIN**
 - 27 2700K
 - 30 3000K
 - 35 3500K
 - 40 4000K
- FASCIO/BEAM**
 - S Spot
 - F Flood
 - Z Asymmetric
- FASCIO/BEAM**
 - S Spot
 - F Flood
 - W Wide

Per i gradi vedere in tabella - For degree check the table

/## FINITURA/FINISHING

- /01 bianco | white
- /02 nero | black
- /49 bronzo | bronze
- /## FINITURA PREMIUM /PREMIUM FINISHING**
 - /81 oro rosa/rose gold
 - /82 bronzo anticato/antique bronze
 - /83 ottone brunito spazzolato/brushed burnished brass

FOCUS MAGNETE MONTATO SU SUPPORTO FERROMAGNETICO MAGNETIC FOCUS MOUNTED ON FERROMAGNETIC SUPPORT



FOCUS MAGNETE MONTATO SU MATERIALE NON FERROMAGNETICO CON L'AUSILIO DELLA PIASTRA D'ANCORAGGIO MAGNETIC FOCUS MOUNTED ON NOT FERROMAGNETIC SURFACE USING THE ANCHOR PLATE



ACCESSORI / ACCESSORIES

PIASTRA ANCORAGGIO MAGNETI ANCHOR PLATE FOR MAGNETIC PROJECTORS

Dim.mm	Hmm	CODE	/##
ø26	3	FSA02.26	
ø36	3	FSA02.36	/01
ø55	3	FSA02.55	/02

LENTI CON ANELLO / LENSES WITH RING

	ø	Kg	CODE	ø	Kg	CODE	ø	Kg	CODE
LENTE SATINATA / SATINED LENS	26	0,01	L026S.A/##	36	0,01	L036S.A/##	55	0,01	L055S.A/##
LENTE ELISSOIDALE / ELIPSOID LENS	26	0,01	L026E.A/##	36	0,01	L036E.A/##	55	0,01	L055E.A/##
LENTE ASIMMETRICA / ASYMMETRIC LENS	26	0,01	L026A.A/##	36	0,01	L036A.A/##	55	0,01	L055A.A/##
FILTRO NIDO D'APE / HONEY COMB LOUVER	26	0,01	L026R.A/##	36	0,01	L036R.A/##	55	0,01	L055R.A/##

350 500 700 DRIVERS VEDI | SEE P. 452

COMPOSIZIONE CODICE: xxx.x ● ● /##

HOW TO CREATE THE CODE: **F1000.827S /01**

CODE
F1000.8 | kelvin | beam | ## finishing

/## FINITURA LENTI/FINISHING LENSES

- /01 bianco | white
- /02 nero | black

FOCUS BASETTA BASE VERSION

FOCUS BASE TONDA ROUND BASE



FOCUS BT26

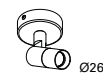
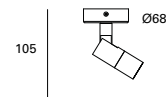

LED		mA		ø	H	lm product/beam 3000K			CODE
W						S15°	F27°	F27°	
5,7		500		26	105	571			FS101.9 ● F /##

● disponibile solo fascio F available only F beam



FOCUS BT36

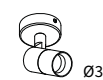
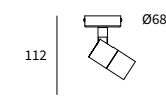

LED		mA		ø	H	lm product/beam 3000K			CODE
W						S15°	F28°	Z18°x38°	
8		700		36	112	665	695	508	FS102.9 ● ● /##



FOCUS BT55

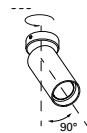
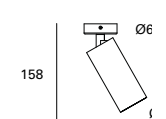

LED		mA		A	ø	H	lm product/beam 3000K			CODE
W							S15°	F27°	W46°	
12,7		350			55	158	1285	1285	1289	FS103.9 ● ● /##
18,5		500			55	158	1575	1575	1579	

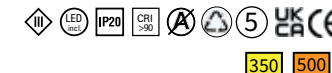

GU10LED		ø		H	CODE
W					
50		55		158	FS105 /##

Accessori - accessories: L055#.A: Anello ø55 + lente lens with ring ø55

ACCESSORI / ACCESSORIES

LENTI CON ANELLO / LENSES WITH RING

	ø	Kg	CODE	/##
LENTE SATINATA / SATINED LENS	55	0,01	L055S.A	
LENTE ELISSOIDALE / ELIPSOID LENS	55	0,01	L055E.A	/01
LENTE ASIMMETRICA / ASYMMETRIC LENS	55	0,01	L055A.A	/02
FILTRO NIDO D'APE / HONEY COMB LOUVER	55	0,01	L055R.A	

VERSIONI DISPONIBILI / AVAILABLE VERSION

KELVIN	FASCIO/BEAM	FASCIO/BEAM	/## FINITURA/FINISHING
27 2700K	S Spot	S Spot	/01 bianco white
30 3000K	F Flood	F Flood	/02 nero black
35 3500K	Z Asymmetric	W Wide	/49 bronzo bronze
40 4000K			

Per i gradi vedere in tabella - For degree check the table

COMPOSIZIONE CODICE: xxx.x ● ● /##

HOW TO CREATE THE CODE: **F1000.827S /01**

CODE

F1000.8	●	●	— /## finishing
base code	kelvin	beam	

/## FINITURA PREMIUM /PREMIUM FINISHING

/81 oro rosa/rose gold
/82 bronzo anticato/antique bronze
/83 ottone brunito spazzolato/brushed burnished brass

350 500 700 DRIVERS VEDI | SEE P. 452

BASE RETTANGOLARE SQUARE BASE



FOCUS BR26

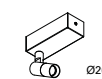
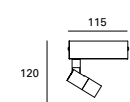

LED		mA		ø	H	lm product/beam 3000K			CODE
W						S15°	F27°	F27°	
5,7		26		120	571				FS401.9 ● F /##

● disponibile solo fascio F available only F beam



FOCUS BR36

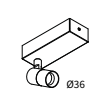
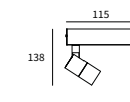

LED		mA		ø	H	lm product/beam 3000K			CODE
W						S15°	F28°	Z18°x38°	
8		36		138	665	695	508		FS402.9 ● ● /##



FOCUS BR55

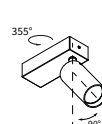
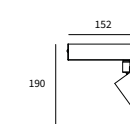

LED		mA		ø	H	lm product/beam 3000K			CODE
W						S15°	F27°	W46°	
12,7		55		190	1285	1285	1289		FS403.9 ● ● /##
18,5		55		190	1575	1575	1579		FS404.9 ● ● /##



Accessori - accessories: L055#.A: Anello ø55 + lente lens with ring ø55



FOCUS 2BR26

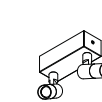
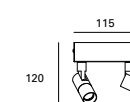

LED		mA		ø	H	lm product/beam 3000K			CODE
W						S15°	F27°	F27°	
11,4		26		120	1142				FS451.9 ● F /##

● disponibile solo fascio F available only F beam



FOCUS 2BR36

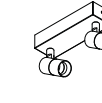
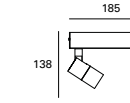

LED		mA		ø	H	lm product/beam 3000K			CODE
W						S15°	F28°	Z18°x38°	
16		36		138	1330	1390	1016		FS452.9 ● ● /##



FOCUS 2BR55

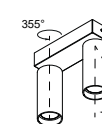
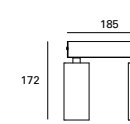

LED		mA		ø	H	lm product/beam 3000K			CODE
W						S15°	F27°	W46°	
25,4		55		172	1285	1285	1289		FS453.9 ● ● /##
37		55		172	1575	1575	1579		FS454.9 ● ● /##



Accessori - accessories: L055#.A: Anello ø55 + lente lens with ring ø55

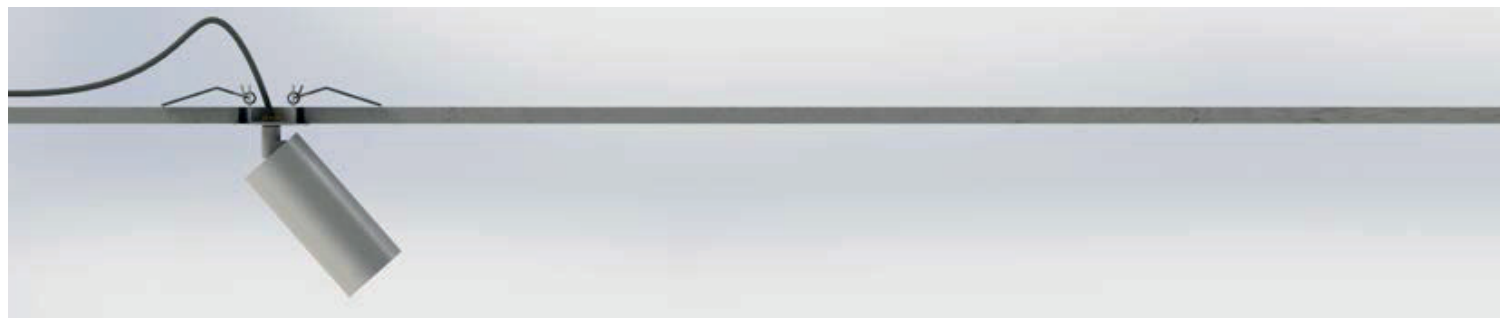

FOCUS PIATTELLO PLATE PER CARTONGESSO - FOR PLASTERBOARD



FOCUS P26

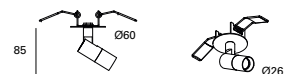

LED W	mA	ø	H	Im product/beam 3000K F27°	CODE
5,7	500	26	85	571	FS201.9 ● F /##

● disponibile solo fascio F available only F beam

FOCUS P36

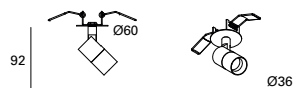

LED W	mA	ø	H	Im product/beam 3000K S19° F28° Z18°x38°	CODE
8	700	36	92	665 695 508	FS202.9 ● ● /##

FOCUS P55

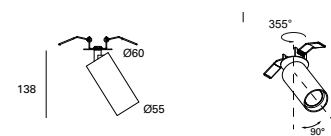

LED W	mA	ø	H	Im product/beam 3000K S15° F27° W46°	CODE
12,7	350	55	138	1285 1285 1289	FS203.9 ● ● /##

GU10 LED 230V W	ø	H	CODE
1 x max 50	55	138	FS205/##

Accessori - accessories: L055#.A: Anello ø55 + lente lens with ring ø55

ACCESSORI / ACCESSORIES

LENTI CON ANELLO / LENSES WITH RING	ø	Kg	CODE	/##
LENTE SATINATA / SATINED LENS	55	0,01	L055S.A	/01
LENTE ELISSOIDALE / ELIPSOID LENS	55	0,01	L055E.A	/02
LENTE ASIMMETRICA / ASYMMETRIC LENS	55	0,01	L055A.A	
FILTRO NIDO D'APE / HONEY COMB LOUVER	55	0,01	L055R.A	

VERSIONI DISPONIBILI / AVAILABLE VERSION

KELVIN	FASCIO/BEAM	FASCIO/BEAM	FINITURA/FINISHING
27 2700K	S Spot	S Spot	/01 bianco white
30 3000K	F Flood	F Flood	/02 nero black
35 3500K	Z Asymmetric	W Wide	/49 bronzo bronze
40 4000K			

Per i gradi vedere in tabella - For degree check the table

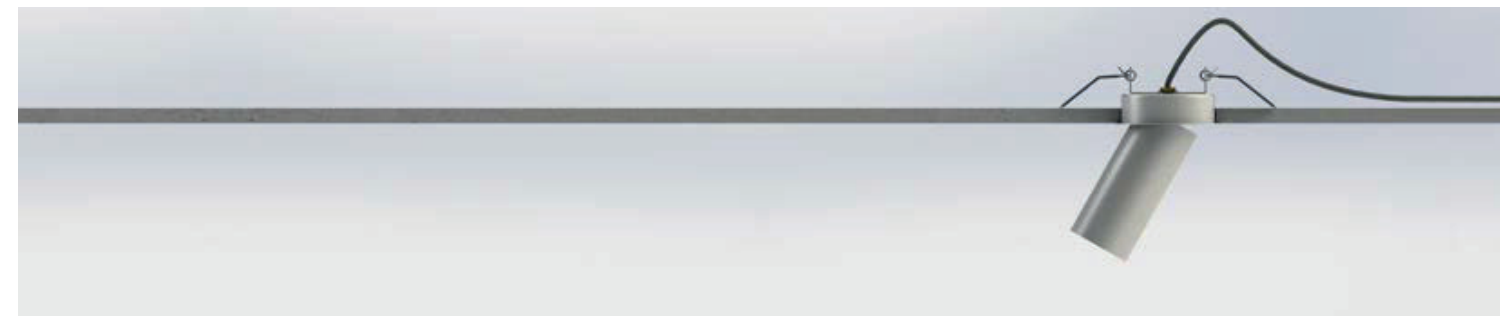

FOCUS BICCHIERE CUP PER CARTONGESSO - FOR PLASTERBOARD



FOCUS B26



LED W	mA	ø	H	Im product/beam 3000K F27°	CODE
5,7	500	26	130	571	FS301.9 ● F /##

● disponibile solo fascio F available only F beam
Accessori - accessories: FSA01: controtelaio minimal - Casing for trimless recessed

FOCUS B36

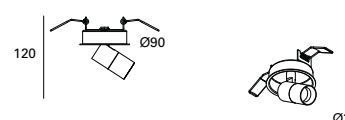

LED W	mA	ø	H	Im product/beam 3000K S19° F28° Z18°x38°	CODE
8	700	36	120	665 695 508	FS302.9 ● ● /##

Accessori - accessories: FSA01: controtelaio minimal - Casing for trimless recessed

FOCUS B55

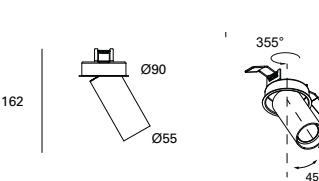

LED W	mA	ø	H	Im product/beam 3000K S15° F27° W46°	CODE
12,7	350	55	162	1285 1285 1289	FS303.9 ● ● /##

GU10 LED W	ø	H	CODE	Col.
1 x max 50	55	162	FS305/##	/01 /02

Accessori - accessories: FSA01: controtelaio minimal - Casing for trimless recessed
L055A.A: Anello ø55 + lente Lens with ring ø55 -

ACCESSORI / ACCESSORIES

CONTROTELAIO PER INCASSO RASATO (OPTIONAL)

CASING FOR TRIMLESS RECESSED



CODE
FSA01

/## FINITURA PREMIUM / PREMIUM FINISHING

/81 oro rosa/rose gold
/82 bronzo anticato/antique bronze
/83 ottone brunito spazzolato/brushed burnished brass

COMPOSIZIONE CODICE: xxx.x ● ● /##

HOW TO CREATE THE CODE: **F1000.827S /01**

CODE

F1000.8	●	●	— /## finishing
base code	kelvin	beam	

350 500 700 DRIVERS VEDI | SEE P. 452

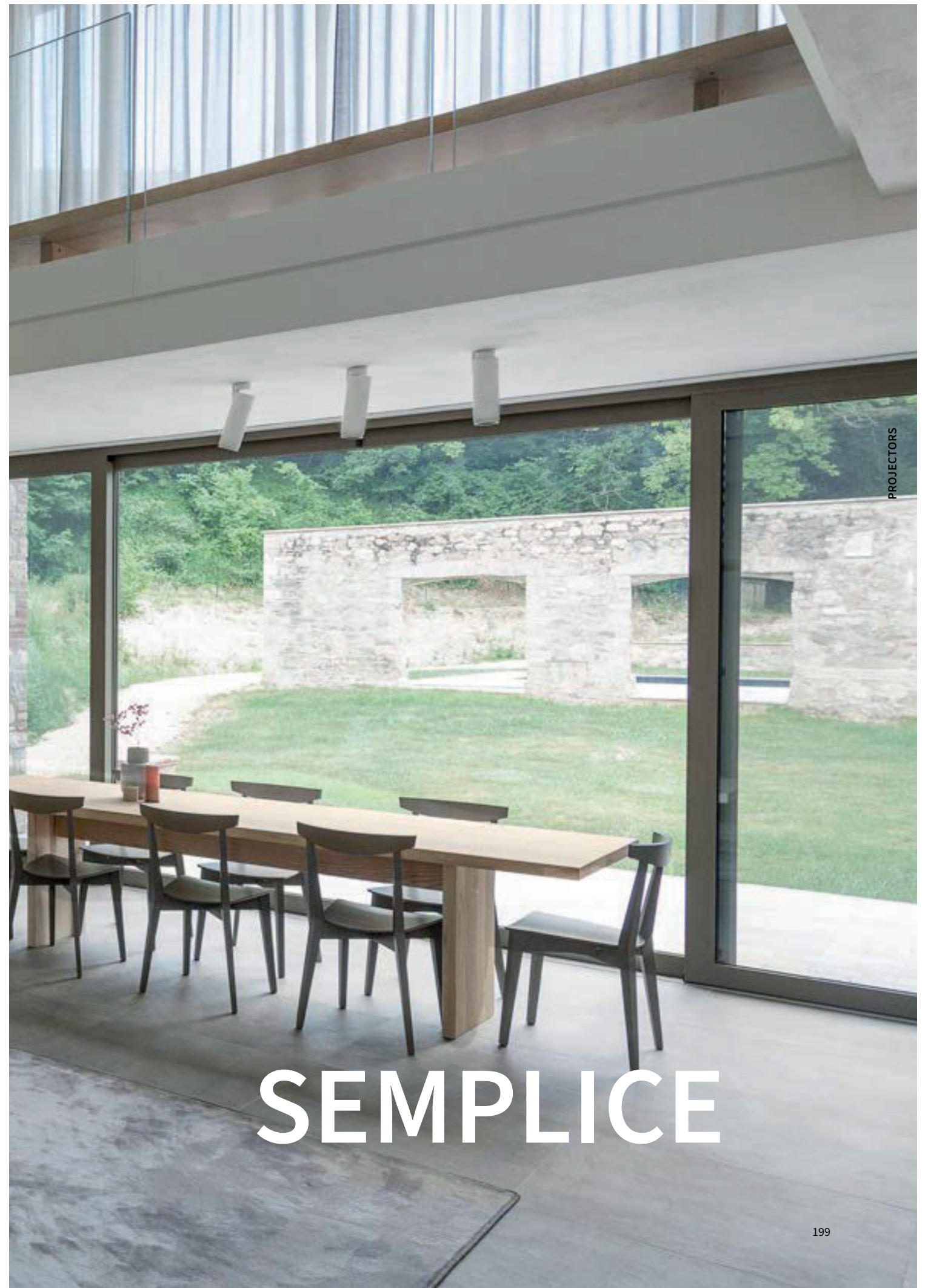

SEMPLICE

PROJECTORS

SEMPLICE

PROIETTORI CON BASETTA - PROJECTORS WITH BASE



altre versioni / more versions

SEMPLICE TRACK 230V

vedi catalogo "Profili Le Collezioni" | see catalogue "Profili Le Collezioni"

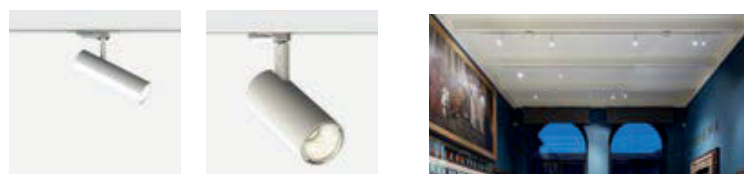

Posizioni di lavoro

Il braccio a slitta permette di assumere diverse posizioni di lavoro e di mantenerle grazie al blocco del puntamento.

Working positions

The slide rod allows to take different working positions and keep them through the aiming lock mechanism.



CEILING POSITION



SUSPENDED POSITION



AIMING POSITION

Proiettori professionali da parete e soffitto completo di sorgente COB LED con ottiche da 15° - 24° - 38° intercambiabili Twist & Lock, disponibili anche nella versione dimmerabile dali e taglio di fase ed in versione per orticoltura. Corpo e gruppo ottico di sezione cilindrica in estruso di alluminio verniciato. Snodi meccanici in acciaio. Orientabilità del gruppo ottico dalla posizione di riposo verticale di 355° sull'asse verticale e da 0° a 90° su quello orizzontale mediante braccio a slitta. Mantenimento della posizione grazie al blocco di puntamento.

Professional wall and ceiling projectors complete with COB LED source with 15° - 24° - 38° Twist & Lock interchangeable optics, available in DALI dimmable, phase cut version and horticulture version also. Cylindrical body and optical group in painted extruded aluminum. Mechanical steel joints. Adjustability of the optical unit from the vertical rest position of 355° on the vertical axis and from 0° to 90° on the horizontal one using the sliding arm. Lockable pointing position.



UK CONFORMITY ASSESSMENT E EUROPEAN CERTIFICATION / UK CONFORMITY ASSESSMENT AND EUROPEAN CERTIFICATION



PRODOTTI COSTRUITI CON MATERIALE RICICLABILE / PRODUCTS MADE OF RECYCLABLE MATERIAL



GARANZIA DI 5 ANNI / 5-YEAR WARRANTY



ORIENTABILE / ADJUSTABLE

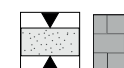

IDONEI PER CARTONGESSO OR LATERIZIO / CALCESTRUZZO a seconda dei modelli e degli accessori. SUITABLE FOR PLASTERBOARD OR BRICKWALL / CONCRETE it depends on the model and its accessories.



HORTICULTURE Disponibili versioni LED HC (Horticulture) a spettro dedicato alle piante ornamentali / HC (Horticulture) LEDs that emit a spectrum tailored to ornamental plants.

KELVIN

27		2700°K
30		3000°K
35		3500°K
40		4000°K
HC		HORTICULTURE

FASCIO/BEAM

S		SPOT
F		FLOOD
W		WIDE

FINITURE STANDARD /STANDARD FINISHINGS

/01		BIANCO/WHITE
/02		NERO/BLACK
/49		BRONZO/BRONZE

FINITURE PREMIUM /PREMIUM FINISHINGS

/81		ORO ROSA/ROSE GOLD
/82		BRONZO ANTICATO / ANTIQUE BRONZE
/83		OTTONE BRUNITO SPAZZOLATO/BRUSHED BURNISHED BRASS

CURVE FOTOMETRICHE/PHOTOMETRIC DATA

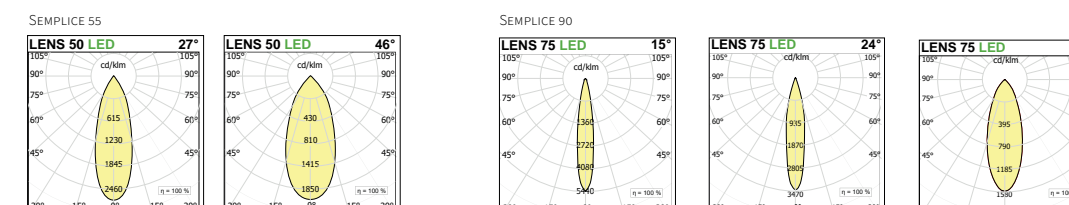



SEMPLICE BASETTA



P55 PARETE-SOFFITTO P55 WALL & CEILING PROJECTOR

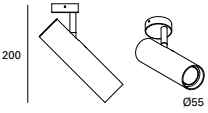

LED W	ø	H	Kg	lm product/beam 3000K			CODE
				S15°	F27°	W46°	
12	55	200	1,0	1285	1285	1289	SE503.9 ●●● /##
18	55	200	1,0	1575	1575	1579	SE504.9 ●●● /##

Accessori - accessories: L055#.A: Anello ø55 + lente a lens with ring ø55

P90 PARETE-SOFFITTO P90 WALL & CEILING PROJECTOR

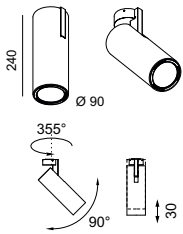

LED W	ø	H	Kg	lm product/beam 3000K			CODE
				S15°	F24°	W38°	
17	90	240-270	1,4	1930	1827	1905	SE501.9 ●●● /##
24,3	90	240-270	1,4	2468	2356	2430	SE502.9 ●●● /##
32	90	240-270	1,4	3006	2885	2955	SE505.9 ●●● /##

Accessori - accessories: L085#.A: Anello ø85 + lente a lens with ring ø85

ACCESSORI / ACCESSORIES



LENTI NYX 55 / LENSES 55				LENTI NYX 85 / LENSES NYX 85				
	ø	Kg	CODE	##	ø	Kg	CODE	##
LENTE SATINATA / SATINED LENS	55	0,01	L055S.A		85	0,01	L085S.A	
LENTE ELISSOIALE / ELIPSOID LENS	55	0,01	L055E.A	/01	85	0,01	L085E.A	/01
LENTE ASIMMETRICA / ASYMMETRIC LENS	55	0,01	L055A.A	/02	85	0,01	L085A.A	/02
FILTRO NIDO D'APE / HONEY COMB LOUVER	55	0,01	L055R.A		85	0,01	L085R.A	

VERSIONI DISPONIBILI / AVAILABLE VERSION

- KELVIN
- KELVIN
- 27 2700K
- 30 3000K
- 35 3500K
- 40 4000K
- HC Horticulture

- FASCIO/BEAM
- S Spot
- F Flood
- W Wide

- DIMMABLE (OPTIONAL)
- D Dali Touch & Dimm
- DF Dimm taglio di fase | dimm trailing /leading edge

- /## FINITURA/FINISHING
- /01 bianco / white
 - /02 nero / black
 - /49 bronzo/bronze

COMPOSIZIONE CODICE: xxx.x ●●● /##
 HOW TO CREATE THE CODE: F1000.827S1/01

CODE

F1000.8 ● ● ● /## — finishing

base code kelvin beam dimmable



PHAR

PHAR

PROIETTORI CON BASETTA - PROJECTORS WITH BASE



altre versioni / more versions

PROIETTORI DA BINARIO - TRACK PROJECTORS

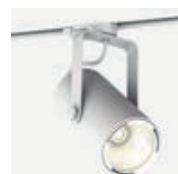

PHAR TRACK 230V
vedi capitolo "Profili Le Collezioni" | see catalogue "Profili Le Collezioni"



UK CONFORMITY ASSESSMENT E EUROPEAN CERTIFICATION / UK CONFORMITY ASSESSTMENT AND EUROPEAN CERTIFICATION



PRODOTTI COSTRUITI CON MATERIALE RICICLABILE / PRODUCTS MADE OF RECYCLABLE MATERIAL



GARANZIA DI 5 ANNI / 5-YEAR WARRANTY



HORTICULTURE Disponibili versioni LED HC (Horticulture) a spettro dedicato alle piante ornamentali / HC (Horticulture) LEDs that emit a spectrum tailored to ornamental plants.

KELVIN	FASCIO/BEAM	FINITURE STANDARD /STANDARD FINISHINGS
27 2700°K	S SPOT 15°	/01 BIANCO/WHITE
30 3000°K	F FLOOD 24°	/02 NERO/BLACK
35 3500°K	W WIDE 38°	/49 BRONZO/BRONZE
40 4000°K		FINITURE PREMIUM /PREMIUM FINISHINGS
HC HORTICULTURE		/81 ORO ROSA/ROSE GOLD
		/82 BRONZO ANTICATO / ANTIQUE BRONZE
		/83 OTTONE BRUNITO SPAZZOLATO/BRUSHED BURNISHED BRASS

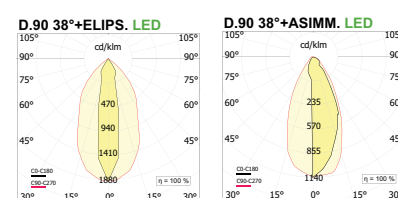
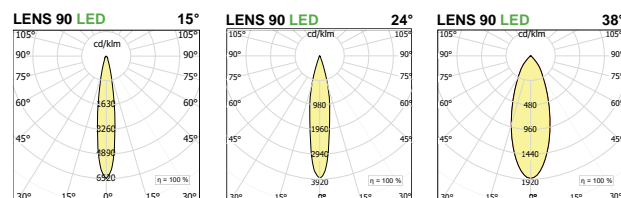

Proiettore professionale da parete e soffitto completo di sorgente COB LED con ottiche da 15° - 24° - 38° intercambiabili Twist & Lock, disponibili anche nella versione dimmerabile dali e taglio di fase ed in versione per orticoltura. Corpo e gruppo ottico di sezione cilindrica in estruso di alluminio verniciato. Snodi meccanici in acciaio. Orientabilità del gruppo ottico dalla posizione di riposo verticale di 355° sull'asse verticale e da 0° a 90° su quello orizzontale. Mantenimento della posizione grazie al blocco di puntamento.

Professional wall and ceiling projectors complete with COB LED source with 15° - 24° - 38° Twist & Lock interchangeable optics, available in DALI dimmable, phase cut version and horticulture version also. Cylindrical body and optical group in painted extruded aluminum. Mechanical steel joints. Adjustability of the optical unit from the vertical rest position of 355° on the vertical axis and from 0° to 90° on the horizontal one. Lockable pointing position.

PHAR 90 PARETE/SOFFITTO WALL/CEILING PROJECTOR

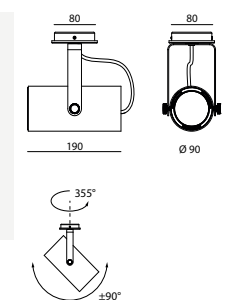

LED W	ø	H	Kg	lm product/beam 3000K			CODE
				S15°	F24°	W38°	
17	90	180	1,4	1930	1827	1905	PH152.9 ●●● /##
24,3	90	180	1,6	2468	2356	2430	PH155.9 ●●● /##
32	90	180	1,6	3006	2885	2955	PH156.9 ●●● /##

Accessori - accessories: L085#.A: Anello ø85 + lente lens with ring ø85

ACCESSORI OPZIONALI / OPTIONAL ACCESSORIES

LENTI NYX 85 / LENSES 85



	ø	Kg	CODE
LENTE SATINATA /SATINED LENS	85	0,01	L085S.A/ ##
LENTE ELISSOIDALE /ELIPSOID LENS	85	0,01	L085E.A/ ##
LENTE ASIMMETRICA /ASYMMETRIC LENS	85	0,01	L085A.A/ ##
FILTRO NIDO D'APE/HONEY COMB LOUVER	85	0,01	L085R.A/ ##

VERSIONI DISPONIBILI/AVAILABLE VERSION

KELVIN	FASCIO/BEAM	DIMMABLE (OPTIONAL)	/## FINITURA/FINISHING
27 2700K	S Spot 15°	D Dali Touch & Dimm	/01 bianco white
30 3000K	F Flood 24°	DF Dimm taglio di fase dimm trailing / leading edge	/02 nero black
35 3500K	W Wide 38°		/49 bronzo/bronze
40 4000K			
HC Horticulture			

Per i gradi vedere in tabella - For degree check the table

INDOOR - Parete, Soffitto, Sospensione e Terra | Wall, Ceiling , Suspension & Floor

MINIFILE MIX P. 212 **NEW**



ICEMENTI P. 217



IPIEDIQ P. 225



IPIEDI P. 231 **NEW**



IBRIDA P. 243 **NEW**



AURA IN P. 259 **NEW**



LEVA P. 263



FILE 2 COMPLEMENTI P. 269

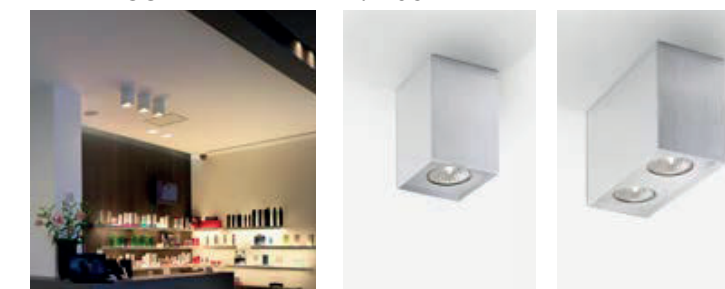

INDOOR - Parete, Soffitto, Sospensione e Terra | Wall, Ceiling , Suspension & Floor

MANINE P. 273 NEW



APP P. 281



MINIFILE MIX



Apparecchi in estruso di alluminio 62x32mm, per installazione a soffitto e sospensione con sorgenti lineari led, a luce diffusa, moduli con microottiche a luminanza controllata antiabbagliamento e spot focus Ø 36 mm, completi di alimentatori elettronici 230/240V. Finitura verniciata o anodizzata. Schermi diffondenti in policarbonato opalino, testate di chiusura laterali con sistema Light Proof. Grado di protezione IP20.

Extruded aluminum profiles 62x32mm, for ceiling and suspension installation with linear LED sources, diffused light, modules with microoptics with controlled anti-glare luminance and spot focus Ø 36 mm, complete with electronic power supply 230/240V. Painted or anodized finish. Diffuser screens in opaline polycarbonate and side closing heads with Light Proof system. Degree of protection IP20.



UK CONFORMITY ASSESSMENT E EUROPEAN CERTIFICATION / UK CONFORMITY ASSESSMENT AND EUROPEAN CERTIFICATION



PRODOTTI COSTRUITI CON MATERIALE RICICLABILE / PRODUCTS MADE OF RECYCLABLE MATERIAL



GARANZIA DI 5 ANNI / 5-YEAR WARRANTY



MONO EMISSIONE O BI EMISSIONE / MONO EMISSION OR DOUBLE EMISSION



ACCENSIONI SEPARATE | SEPARATE IGNITION

Le versioni a luce diretta ed indiretta sono sempre predisposte per accensioni separate | Direct and indirect version are always prepared for independent ignition

KELVIN

27		2700°K
30		3000°K
35		3500°K
40		4000°K

FASCIO / BEAM

F		FLOOD
W		WIDE

FINITURE / FINISHINGS

/01		TELAIO BIANCO OTTICA NERA / WHITE FRAME BLACK OPTIC
/02		TELAIO NERO OTTICA NERA / BLACK FRAME BLACK OPTIC
/41		TELAIO BIANCO OTTICA BIANCA / WHITE FRAME WHITE OPTIC
/42		TELAIO NERO OTTICA ORO / BLACK FRAME GOLD OPTIC

FINITURE PREMIUM / PREMIUM FINISHINGS

81-ORO ROSA / PINK GOLD	82-BRONZO ANTICATO/ANTIQUE BRONZE	83-OTTONE SATINATO/ BRUSHED BRASS

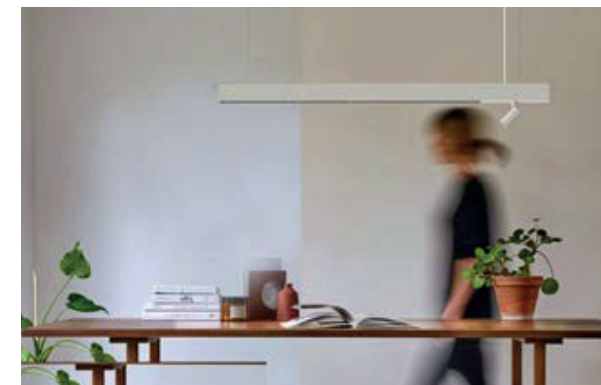

CURVE FOTOMETRICHE/PHOTOMETRIC DATA

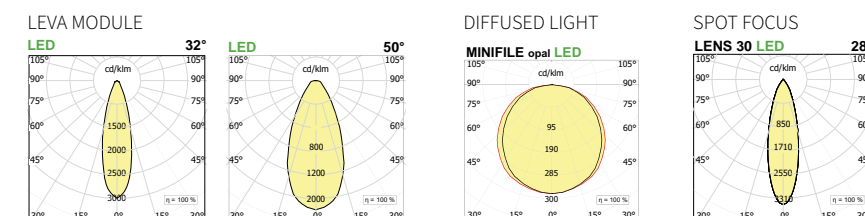

MINIFILE MIX SOSPENSIONE SUSPENSION



LUCE DIRETTA LEVA + 1 FOCUS DIRECT LIGHT

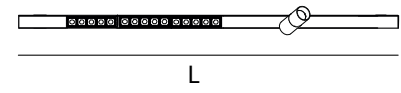

W	Lmm	Kg	∅	H	lm product/beam 3000K	F32°	W50°	CODE
33W						2793	2484	
+ spot 1 x 8w	1140	2,20	36	92	beam F28° 695lm			MM001.9 ●●●/##

LUCE DIRETTA LEVA + 2 FOCUS DIRECT LIGHT

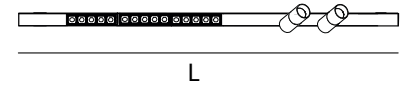

W	Lmm	Kg	∅	H	lm product/beam 3000K	F32°	W50°	CODE
33W						2793	2484	
+ spots 2 x 8w	1140	2,20	36	92	beam F28° 1390 lm			MM002.9 ●●●/##

LUCE DIFFUSA + 1 FOCUS DIFFUSED LIGHT

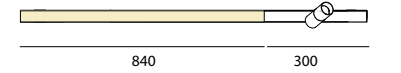

W	Lmm	Kg	∅	H	lm product/beam 3000K	F32°	W50°	CODE
19,2W					1085			
+ spot 1 x 8w	1140	2,20	36	92	beam F28° 695lm			MM005.9 ●●●/##

LUCE DIFFUSA + 2 FOCUS DIFFUSED LIGHT

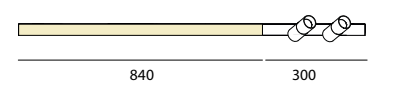

W	Lmm	Kg	∅	H	lm product/3000K	F32°	W50°	CODE
19,2					1085			
+ spots 2 x 8w	1140	2,20	36	92	beam F28° 1390 lm			MM006.9 ●●●/##

LEVA + 1 FOCUS LUCE DIRETTA-INDIRETTA DIRECT-INDIRECT LIGHT

Prodotto predisposto per accensioni separate | product prepared for independent ignition



	W	Lmm	Kg	∅	H	lm product/beam 3000K	F32°	W50°	CODE
direct	33W					2793	2484		
+ spot 1 x 8w		1140	2,20	36	92	beam F28° 695lm			MM003.9 ●●●/##
indirect	+ 9,9					574			

LEVA + 2 FOCUS A LUCE DIRETTA-INDIRETTA DIRECT-INDIRECT LIGHT

Prodotto predisposto per accensioni separate | product prepared for independent ignition

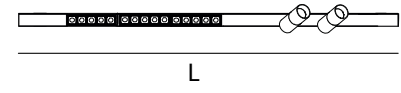

	W	Lmm	Kg	∅	H	lm product/beam 3000K	F32°	W50°	CODE
direct	33W					2793	2484		
+ spots 2 x 8w		1140	2,20	36	92	beam F28° 1390 lm			MM004.9 ●●●/##
indirect	+ 9,9					574			

LUCE DIFFUSA + 1 FOCUS A LUCE DIRETTA-INDIRETTA DIFFUSED LIGHT + 1 FOCUS DIRECT-INDIRECT LIGHT

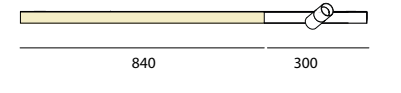

	W	Lmm	Kg	∅	H	lm product/beam 3000K	F32°	W50°	CODE
direct	19,2W					1085			
+ spot 1 x 8w		1140	2,20	36	92	beam F28° 695 lm			MM007.9 ●●●/##
indirect	+ 9,9					574			

LUCE DIFFUSA + 2 FOCUS A LUCE DIRETTA-INDIRETTA DIFFUSED LIGHT + 2 FOCUS DIRECT-INDIRECT LIGHT

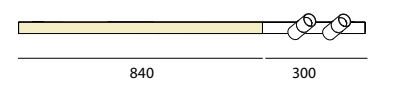

	W	Lmm	Kg	∅	H	lm product/3000K	F32°	W50°	CODE
direct	19,2					1085			
+ spots 2 x 8w		1140	2,20	36	92	beam F28° 1390 lm			MM008.9 ●●●/##
indirect	+ 9,9					574			

MINIFILE MIX SOFFITTO CEILING

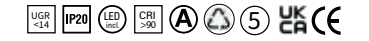

LUCE DIRETTA LEVA + 1 FOCUS DIRECT LIGHT

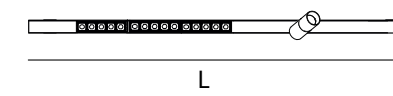

W	Lmm	Kg	∅	H	lm product/beam 3000K	F32°	W50°	CODE
33W						2793	2484	
+ spot 1 x 8w	1140	2,20	36	92	beam F28° 695 lm			MM011.9 ●●●/##

LUCE DIRETTA LEVA + 2 FOCUS DIRECT LIGHT

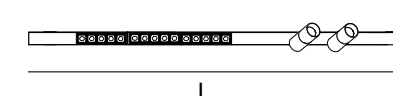

W	Lmm	Kg	∅	H	lm product/beam 3000K	F32°	W50°	CODE
33W						2793	2484	
+ spots 2 x 8w	1140	2,20	36	92	beam F28° 1390 lm			MM012.9 ●●●/##

LUCE DIFFUSA + 1 FOCUS DIFFUSED LIGHT

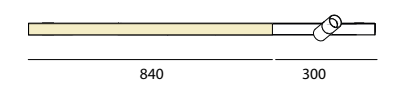

W	Lmm	Kg	∅	H	lm product/beam 3000K	F32°	W50°	CODE
19,2W					1085			
+ spot 1 x 8w	1140	2,20	36	92	beam F28° 695 lm			MM015.9 ●●●/##

LUCE DIFFUSA + 2 FOCUS DIFFUSED LIGHT

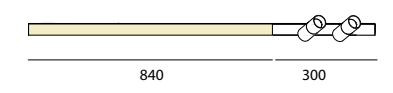

W	Lmm	Kg	∅	H	lm product/3000K	F32°	W50°	CODE
19,2					1085			
+ spots 2 x 8w	1140	2,20	36	92	beam F28° 1390 lm			MM016.9 ●●●/##

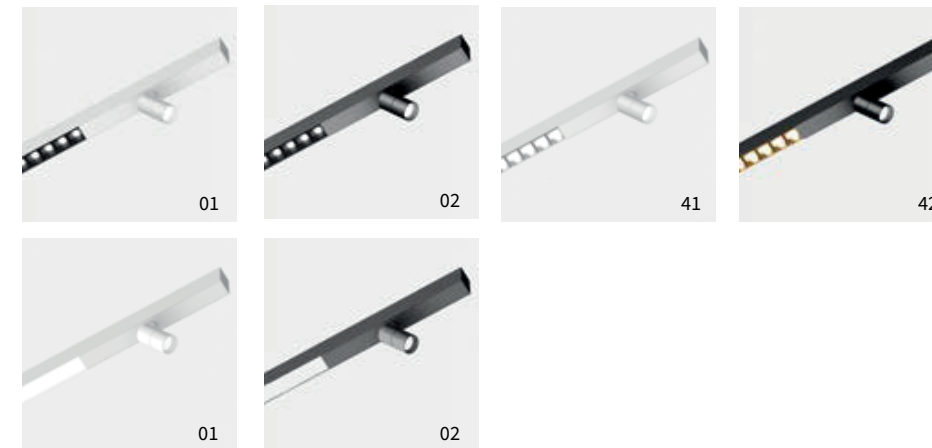

VERSIONI DISPONIBILI/AVAILABLE VERSION

KELVIN

- 27 2700K
- 30 3000K
- 35 3500K
- 40 4000K

FASCIO / BEAM

- S Spot
- F Flood
- W Wide

DIMMABLE

- D Dali Touch & Dimm

/## FINITURA/FINISHING

- /01 bianco | white
- /02 nero | black
- /41 telaio bianco, ottica bianca | white frame, white optic
- /42 telaio nero, ottica oro | black frame, gold optic
- /## FINITURA PREMIUM /PREMIUM FINISHING
- /81 oro rosa/rose gold
- /82 bronzo anticato/antique bronze
- /83 ottone brunito spazzolato/brushed burnished brass

Per i gradi vedere in tabella - For degree check the table

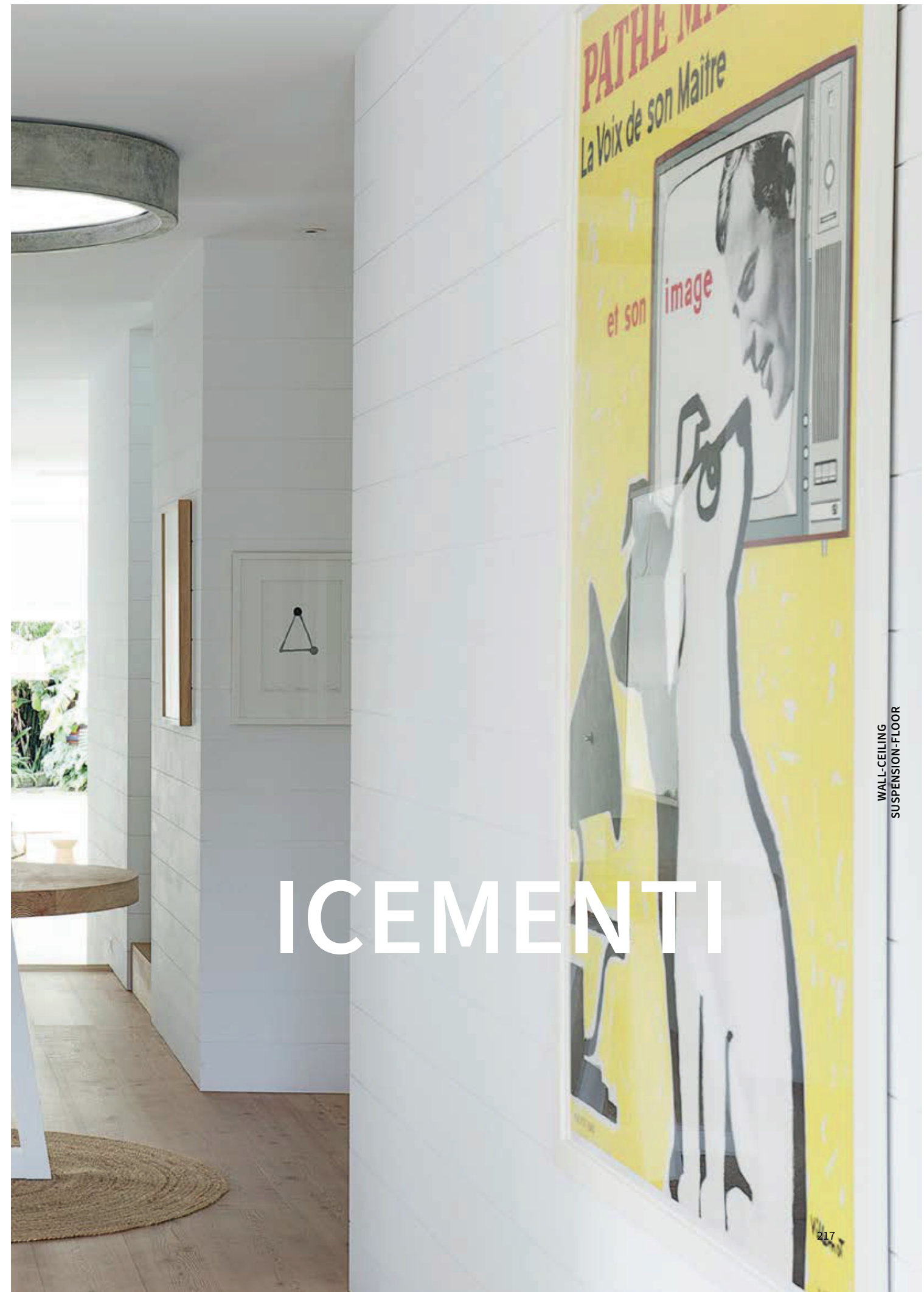

ICEMENTI



PRIVATE RESIDENCE - PERTH, AUSTRALIA
ARCHITECT: WRIGHT FELDHUSEN ARCHITECTS
LIGHTING PROJECT: GINEICO LIGHTING

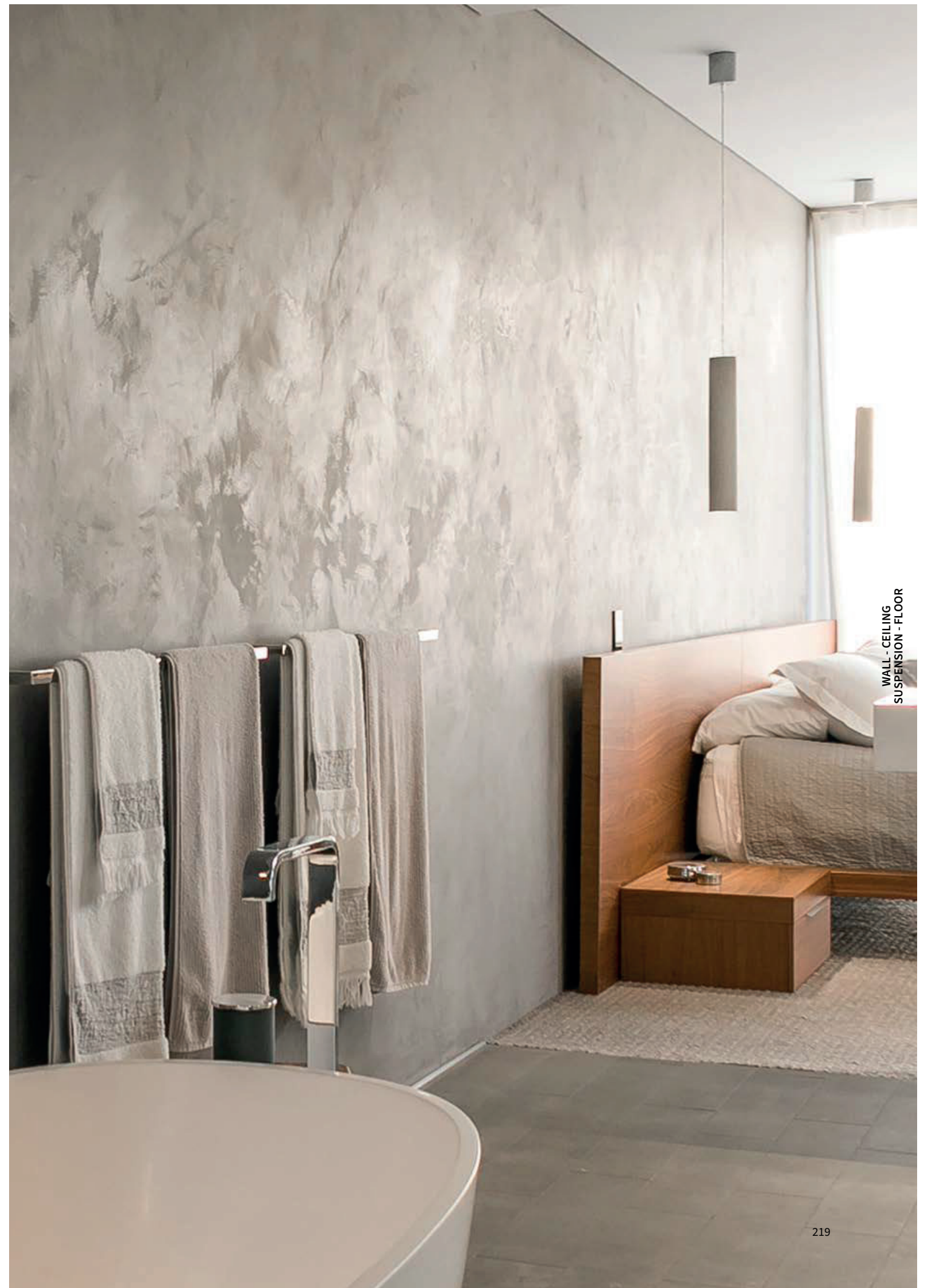

WALL - CEILING
SUSPENSION - FLOOR

ICEMENTI



051



BRIQUE



2B02

2B01

altre versioni / other versions
OUTDOOR
 vedi sezione "OUTDOOR" | see chapter "OUTDOOR"



PANCA



PASTORALE



CENTOTRECENTO



BRIQUE

Famiglia di apparecchi da soffitto, sospensione e parete, per illuminazione diffusa o diretta/indiretta. Completi di sorgenti LED chip on board e alimentazione elettronica integrata 50/60Hz.

Corpo in VFRC (vinilic fiber reinforced concrete) cemento fibrato alleggerito. Le versioni a luce diffusa sono dotate di schermo diffondente in PC opalino bianco (Zero51). Nelle versioni da parete il gruppo ottico è in alluminio con vetro temperato extrachiaro. Grado di protezione IP20, IP40 o IP65 a seconda dei modelli.

Family of ceiling, suspended and wall luminaires, for diffused or direct/indirect lighting. Complete with chip on board LED sources and integrated 50/60Hz electronic power supply. Body in VFRC (vinyl fiber reinforced concrete) lightweight cement fiber. The diffused light versions are equipped with a white opal PC (Zero51). In the wall versions the optical unit is in aluminum with extra-clear tempered glass. IP20, IP40 or IP65 depending on the models.



UK CONFORMITY ASSESSMENT E EUROPEAN CERTIFICATION / UK CONFORMITY ASSESSTMENT AND EUROPEAN CERTIFICATION



PRODOTTI COSTRUITI CON MATERIALE RICICLABILE / PRODUCTS MADE OF RECYCLABLE MATERIAL



GARANZIA DI 5 ANNI / 5-YEAR WARRANTY

KELVIN

27		2700°K
30		3000°K
35		3500°K
40		4000°K

CURVE FOTOMETRICHE/PHOTOMETRIC DATA

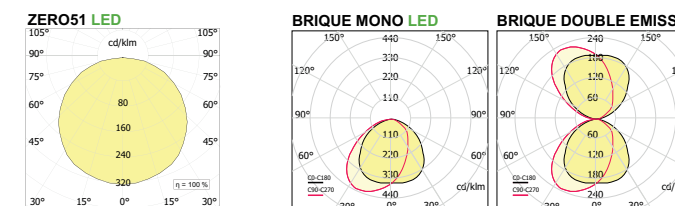

ZERO51 SOFFITTO - CEILING MOUNTED

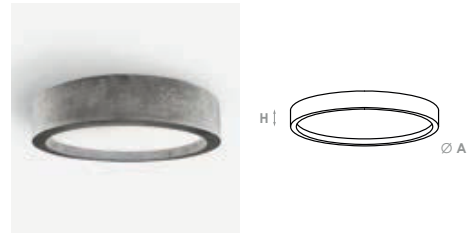

LED

W	Ø	H	Kg	lm prod.3000K	CODE
45	700	150	17	3358	IC210.8 ○●
96	1000	150	26	6716	IC211.8 ○●
168	1300	150	40	11752	IC212.8 ○●

LED IP30 CRI >90 A 5 UK CE

ZERO51 SOSPENSIONE - HANGING



LED

W	Ø	H	Kg	lm prod.3000K	Dali
45	700	150	18	3358	IC220.8 ○●
96	1000	150	27	6716	IC221.8 ○●
168	1300	150	41	11752	IC222.8 ○●

LED IP30 CRI >90 A 5 UK CE

2B02 SOFFITTO - CEILING



QPAR30 E27 230V

W	Ø	H	Kg	CODE
1 x max 100	120	280	3.10	IC1201

Lampadina non inclusa | Lamp not included

LED IP20 230V AC 5 UK CE

2B02 SOSPENSIONE - HANGING

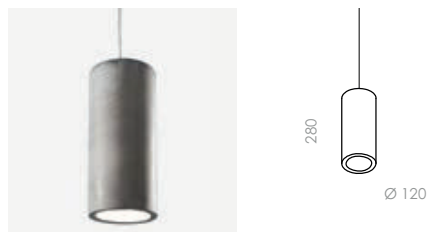

QPAR30 E27 230V

W	Ø	H	Kg	CODE
1 x max 100	120	280	3.5	IC1301

Lampadina non inclusa | Lamp not included

LED IP20 230V AC 5 UK CE

2B01 SOSPENSIONE - HANGING



LED GU10 230V

W	Ø	H	Kg	CODE
1 x max 50	80	450	2.96	IC1401

Lampadina non inclusa | Lamp not included

LED IP20 230V AC 5 UK CE

BRIQUE O PARETE - WALL



LED 230V

W	Dim.	H	Kg	lm prod.3000K	CODE
1x8	120x250	80	3	758	IC810.8 ○●
2x8	120x250	80	3	1515	IC811.8 ○●

LED IP65 CRI >90 A 5 UK CE

BRIQUE V PARETE - WALL

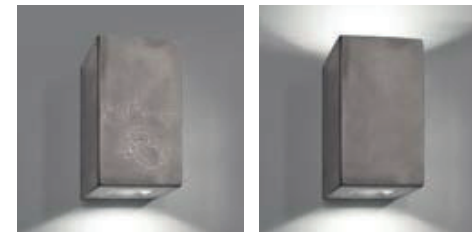

LED 230V

W	Dim.	H	Kg	lm prod.3000K	CODE
1x8	120x100	200	3	758	IC910.8 ○●
2x8	120x100	200	3	1515	IC911.8 ○●

LED IP65 CRI >90 A 5 UK CE

VERSIONI DISPONIBILI/AVAILABLE VERSION

- KELVIN ○ KELVIN ● DIMMABLE (OPTIONAL)
- D Dali
- 27 2700K 30 3000K
- 30 3000K 40 4000K
- 35 3500K
- 40 4000K

COMPOSIZIONE CODICE: xxx.x●●/##
 HOW TO CREATE THE CODE: **F1000.827D/01**

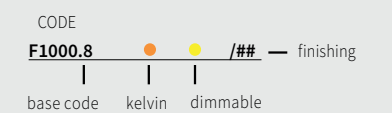

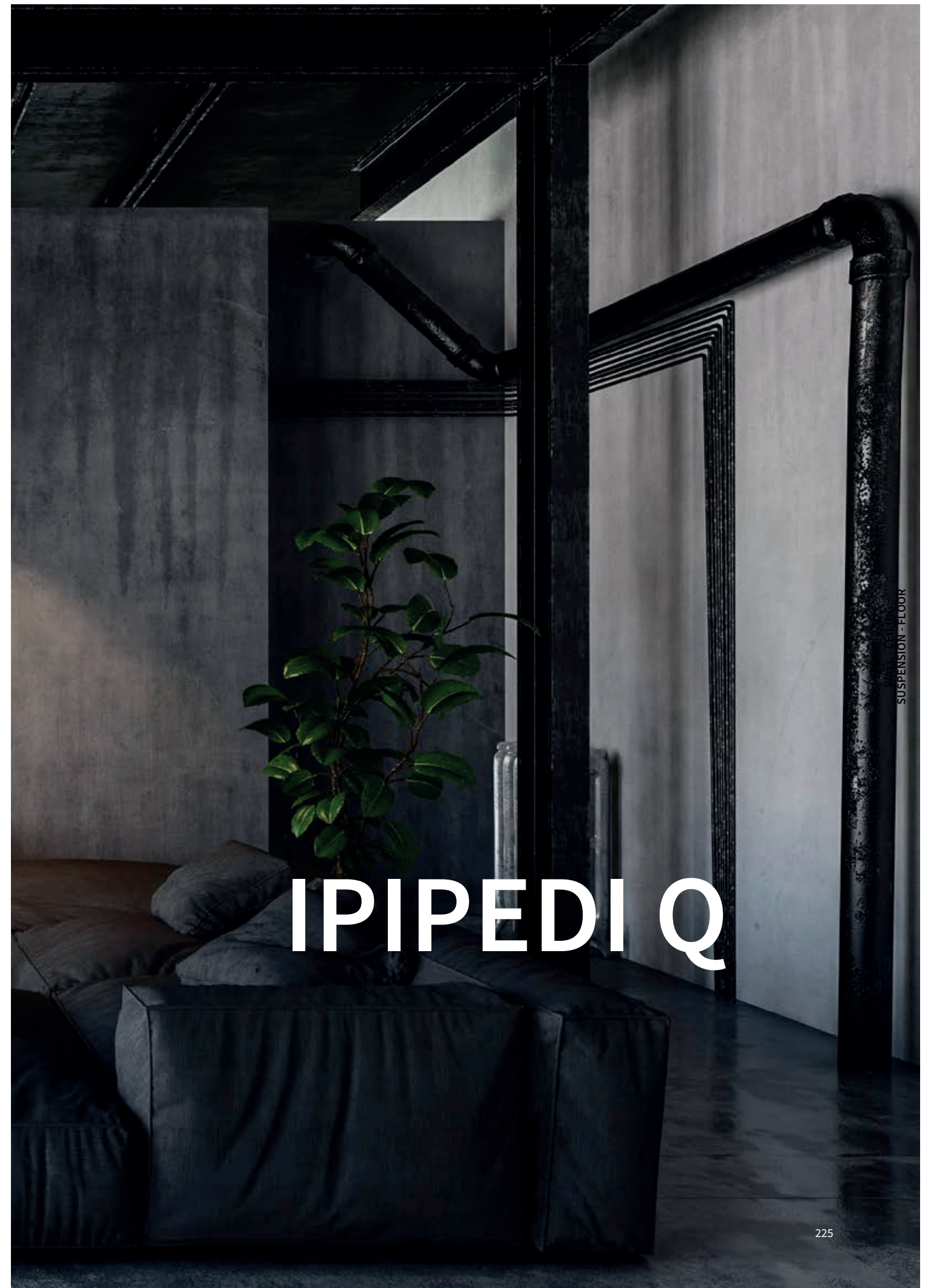

IPIPEDI Q

IPIPEDI Q

LAMPADA DA SOFFITTO - CEILING LAMP



LAMPADA DA PARETE - WALL LAMP



UK CONFORMITY ASSESSMENT E EUROPEAN CERTIFICATION / UK CONFORMITY ASSESSMENT AND EUROPEAN CERTIFICATION



PRODOTTI COSTRUITI CON MATERIALE RICICLABILE / PRODUCTS MADE OF RECYCLABLE MATERIAL



GARANZIA DI 5 ANNI / 5-YEAR WARRANTY

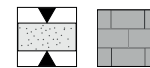

IDONEI PER CARTONGESSO OR LATERIZIO / CALCESTRUZZO a seconda dei modelli e degli accessori. SUITABLE FOR PLASTERBOARD OR BRICKWALL / CONCRETE it depends on the model and its accessories.



GU10

SORGENTE LED GU10 / GU10 LIGHT SOURCE

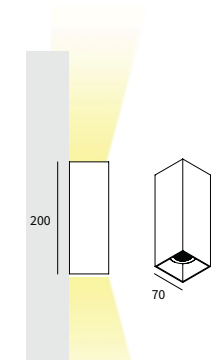
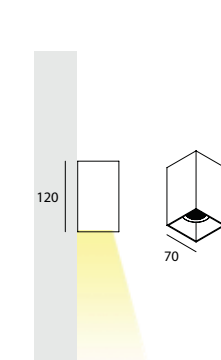
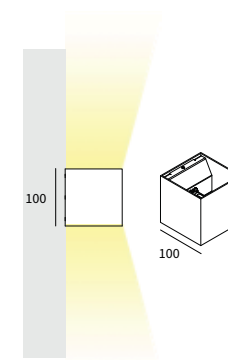

FINITURE STANDARD / STANDARD FINISHINGS

- /01 BIANCO/WHITE
- /02 NERO/BLACK
- /60 CORTEN/CORTEN
- /99 GRAFITE/GRAPHITE

FINITURE PREMIUM / PREMIUM FINISHINGS

- /81 ORO ROSA/ROSE GOLD
- /82 BRONZO ANTICATO/ ANTIQUE BRONZE
- /83 OTTONE BRUNITO SPAZZOLATO/ BRUSHED BURNISHED BRASS

Apparecchi a soffitto o parete per illuminazione diretta o diretta /indiretta, per sorgenti a tensione di rete LED con attacco GU10 o G9. Corpo a sezione quadrata in estruso di alluminio in finitura verniciata. Completi di staffa per fissaggio a soffitto o parete a seconda del modello. Grado di protezione IP20 e classe I.

Ceiling or wall mounted luminaires for direct or direct/indirect lighting, for LED mains voltage sources with GU10 or G9 socket. Square section body in extruded aluminum in painted finish. Complete with bracket for ceiling or wall mounting depending on the model. IP20 and class I.

CURVE FOTOMETRICHE/PHOTOMETRIC DATA

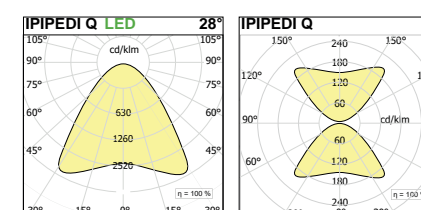



IPIEDI Q SOFFITTO - CEILING
GU10 SOFFITTO CEILING

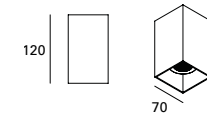
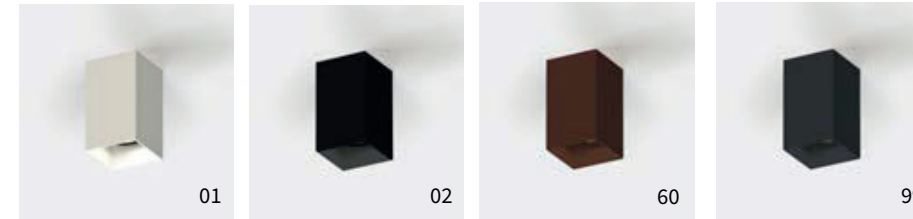

GU10LED Dim. H
W 50 70x70 120 CODE
PPQ20/##

IPIEDI Q PARETE - WALL

GU10 PARETE MONOEMISSIONE WALL - MOUNTED MONOEMISSION

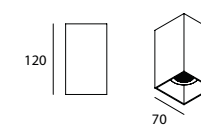
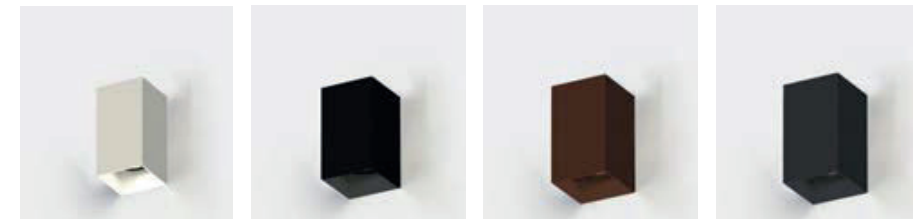

GU10LED Dim. H
W 50 70x70 120 CODE
PPQ11/##

GU10 PARETE BIEMISSIONE WALL - MOUNTED DOUBLE EMISSION

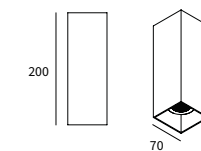

GU10LED Dim. H
W 2x50 70x70 200 CODE
PPQ12/##

G9 BIEMISSIONE PARETE WALL - MOUNTED DOUBLE EMISSION

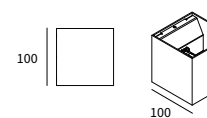
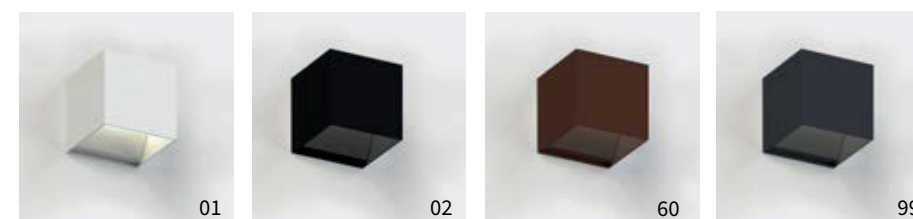

G9 230V Dim. H
W 1 X max 60 100x100 100 CODE
PPQ10/##

VERSIONI DISPONIBILI/AVAILABLE VERSION

- /## FINITURA/FINISHING (PREMIUM AVAILABLE)**
- /01 bianco/white
 - /02 nero/black
 - /60 corten / corten
 - /99 grafite/graphite

COMPOSIZIONE CODICE: xxx.x /##

HOW TO CREATE THE CODE: **F1000/01**

CODE
F1000 /## — finishing
|
base code

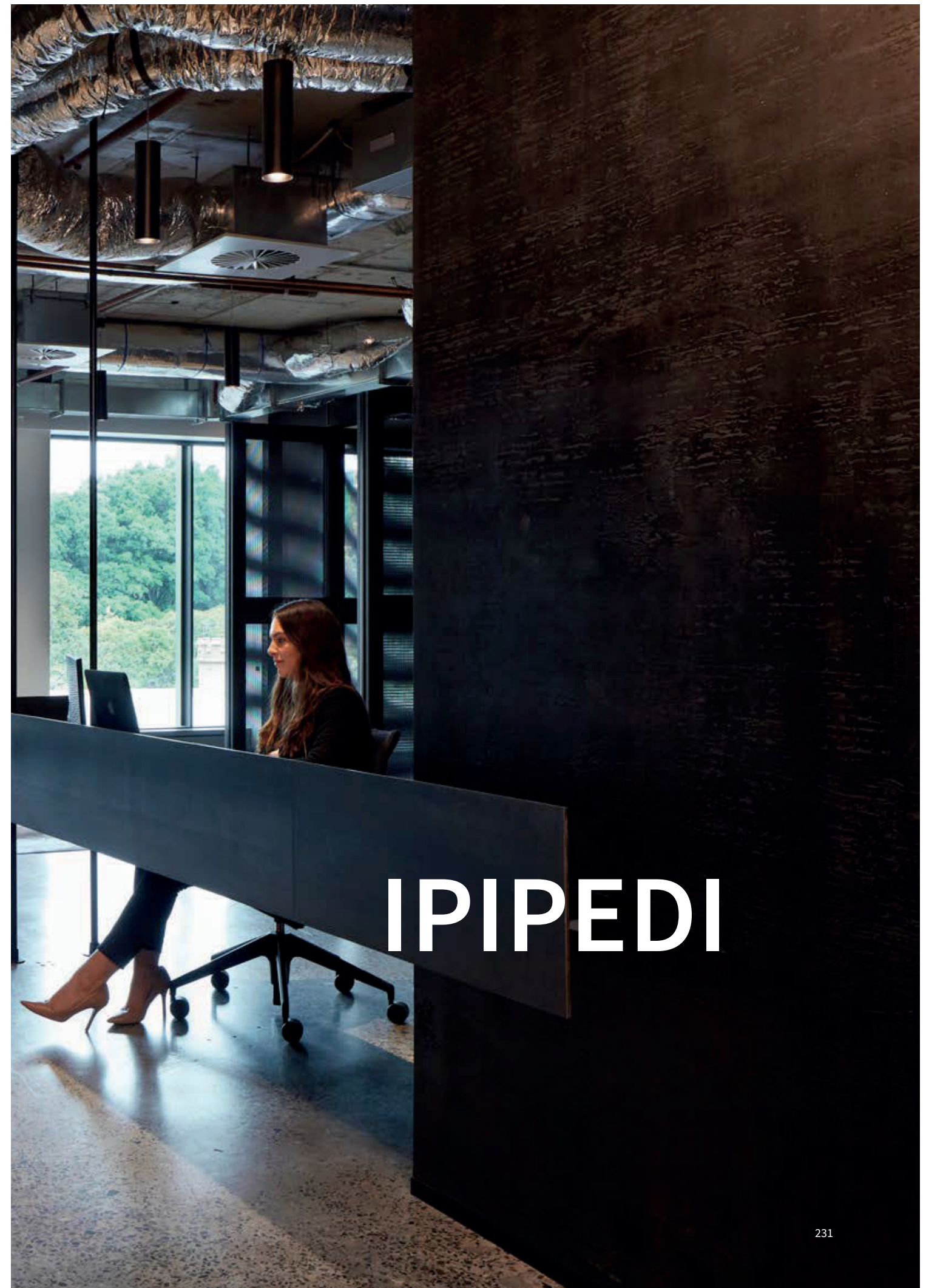

IPIPEDI

IPIPEDI

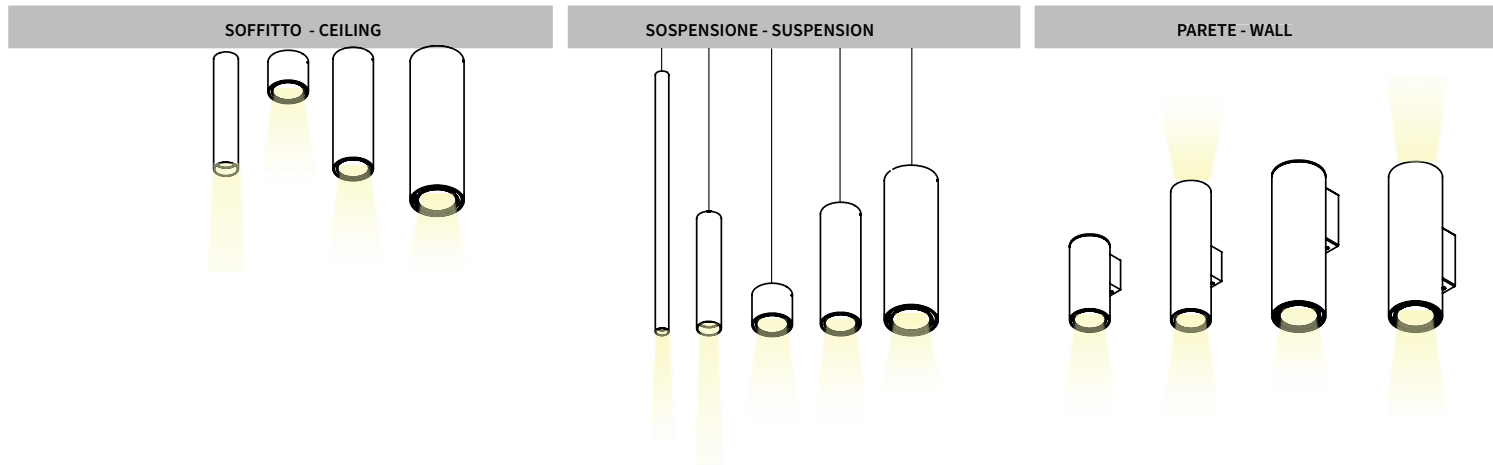

LENTI ACCESSORIE CON ANELLO / ACCESSORIES LENSES WITH RING



Apparecchi a soffitto, sospensione e parete e per binario MiniTrack 24/48V per illuminazione diretta o diretta/indiretta, completi di sorgenti LED professionali o per lampade LED GU10 230V. Completati di gruppo di alimentazione. Corpo cilindrico in estruso di alluminio finitura verniciata. Completati di staffa per fissaggio a soffitto, cavi di sospensione in acciaio con sistema di regolazione micrometrica e cavo di alimentazione L.2000 mm. o basetta di fissaggio a parete a seconda dei modelli. Grado di protezione IP20.

Ceiling, suspended or wall luminaires, available suspension for Mini Track 24/48V for direct or direct/indirect lighting, complete with professional LED sources or GU10 230V LED bulbs. Integrated power supply unit. Cylindrical body in extruded aluminum with painted finish. Complete with ceiling mounting brackets, steel suspension cables with micrometric adjustment system and power cable L.2000 mm. or wall fixing base according to the models. IP20.



UK CONFORMITY ASSESSMENT E EUROPEAN CERTIFICATION / UK CONFORMITY ASSESSMENT AND EUROPEAN CERTIFICATION



PRODOTTI COSTRUITI CON MATERIALE RICICLABILE / PRODUCTS MADE OF RECYCLABLE MATERIAL



GARANZIA DI 5 ANNI / 5-YEAR WARRANTY



VERSIONI CON SORGENTE LED GU10 DISPONIBILI / AVAILABLE GU10 LIGHT SOURCE VERSION

KELVIN	
27	2700°K
30	3000°K
35	3500°K
40	4000°K

FASCIO/BEAM

S		SPOT
F		FLOOD
W		WIDE

FINITURE STANDARD / STANDARD FINISHINGS

/01		BIANCO/WHITE
/02		NERO/BLACK
/60		CORTEN/CORTEN
/99		GRAFITE/GRAPHITE

FINITURE PREMIUM / PREMIUM FINISHINGS

/81		ORO ROSA/ROSE GOLD
/82		BRONZO ANTICATO / ANTIQUE BRONZE
/83		OTTONE BRUNITO SPAZZOLATO / BRUSHED BURNISHED BRASS

CURVE FOTOMETRICHE / PHOTOMETRIC DATA

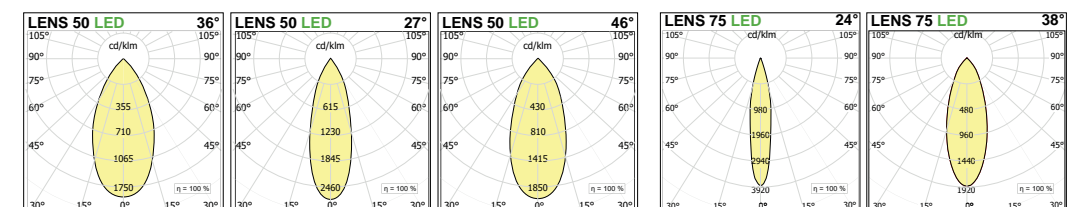

iPipedi

Sospensione | Suspension
Ø30

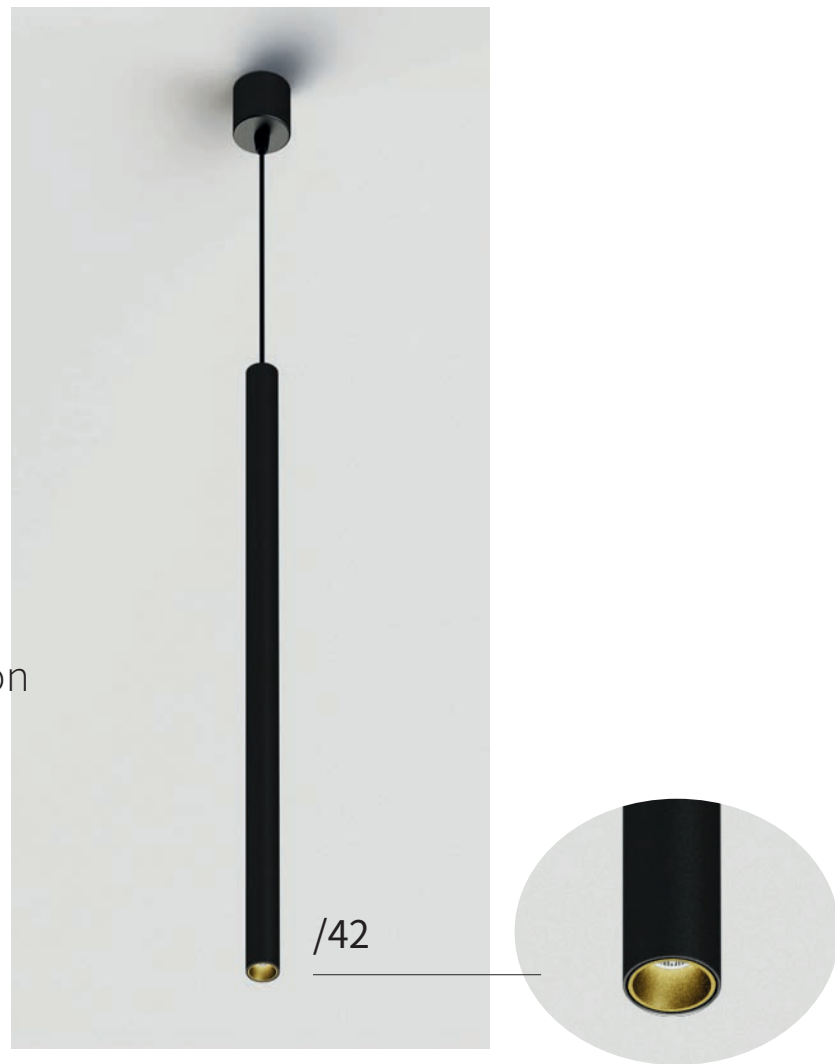

Con il suo design sottile e lungo, caratterizzato da una forma cilindrica raffinata, iPipedi Ø 30 a sospensione è pensato per creare una luce d'accento sofisticata racchiusa in soli 30 mm di diametro, perfetta per illuminare con stile ogni spazio. Con la sua versatilità, si adatta magnificamente a diverse situazioni, aggiungendo un tocco di contemporaneità e raffinatezza.

With its slim, long design, characterized by a refined cylindrical shape, the suspension iPipedi Ø 30 is designed to create a sophisticated accent light enclosed in just 30 mm in diameter, perfect for lighting up any space with style. With its versatility, it adapts beautifully to different situations, adding a touch of contemporaneity and sophistication



Ø30

IPIPEDI R30S SOSPENSIONE | SUSPENSION

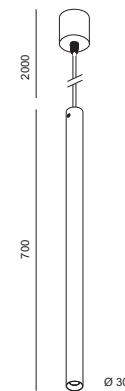

LED				lm product/beam 3000K		
W	mA	∅	H	S16°	F30°	CODE
1,5	150	30	700	252	136	PP001.9 ●●● /##
8	700	30	700	695	720	

ACCESSORI OPTIONAL / OPTIONAL ACCESSORIES

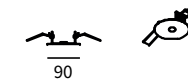

PIATTELLO PER INSTALLAZIONE A CARTONGESSO |
PLATE FOR INSTALLATION IN PLASTERBOARD



∅	CODE
90	PP00P/##

● KELVIN

- 27 2700K
- 30 3000K
- 35 3500K
- 40 4000K

● FASCIO/BEAM

- S Spot
- F Flood

Per i gradi vedere in tabella -
For degree check the table

/## FINITURA/FINISHING

- /01 bianco/white
- /02 nero/black
- /42 nero e oro / black & gold
- /60 corten /corten

PREMIUM FINISHING AVAILABLE



iPipedi

Sospensione | Suspension

Ø55 - Ø90

Ø55

IPIPEDI R55S

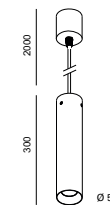

LED		Im product/beam 3000K		CODE		
W	Ø	H	Kg	F27°	W46°	
8	55	300	0,25	860	860	PP151.9
LED		Im product/beam 3000K		CODE		
W	Ø	H	Kg	F27°	W46°	
12	55	300	1,26	1289	1289	PP112.9
18	55	300	1,26	1579	1579	PP152.9
GU10 LED 230V		CODE				
W	Ø	H	Kg			
1x max 50	55	300	1,22	PP113 /##		

Ø90

I-PIPEDI R90S H300

Versione base con driver dimmerabile taglio di fase incluso | Trailing/leading edge dimmable included in Led base version.

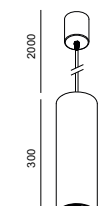

LED		Im product/beam 3000K		CODE		
W	Ø	H	Kg	F24°	W38°	
17	90	300	1827	1905		PP121.9
24,3	90	300	2356	2430		PP122.9
GU10 LED 230V		CODE				
W	Ø	H	Kg			
1x max 50	90	300		PP123 /##		

Accessori - accessories: L085#.A: Anello ø85 - Lens with ring ø85

IPIPEDI R90S H90

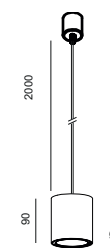

LED		Im product/beam 3000K		CODE		
W	Ø	H	Kg	F24°	W38°	
12	90	90	1,0	1289	-	PP155.9
17	90	90	1,4	1827	1905	PP156.9
24,3	90	90	1,4	2356	2430	PP157.9



KELVIN

- 27 2700K
- 30 3000K
- 35 3500K
- 40 4000K

FASCIO/BEAM

- F Flood
- W Wide

DIMMABLE (OPTIONAL)

- D Dali
- DF Dimm taglio di fase | dimm trailing /leading

/## FINITURA/FINISHING (PREMIUM AVAILABLE)

- /01 bianco/white
- /02 nero/black
- /60 corten /corten
- /99 grafite/graphite

Per i gradi vedere in tabella - For degree check the table

ACCESSORI / ACCESSORIES



LENTI CON ANELLO / LENSES WITH RING		Ø	Kg	CODE	/##
LENTE SATINATA / SATINED LENS		55	0,01	L055S.A	
		85	0,01	L085S.A	
LENTE ELLISSOIALE / ELIPSOID LENS		55	0,01	L055E.A	/01
		85	0,01	L085E.A	/02
LENTE ASIMMETRICA / ASYMMETRIC LENS		55	0,01	L055A.A	
		85	0,01	L085A.A	
FILTRO NIDO D'APE / HONEY COMB LOUVER		55	0,01	L055R.A	
		85	0,01	L085R.A	

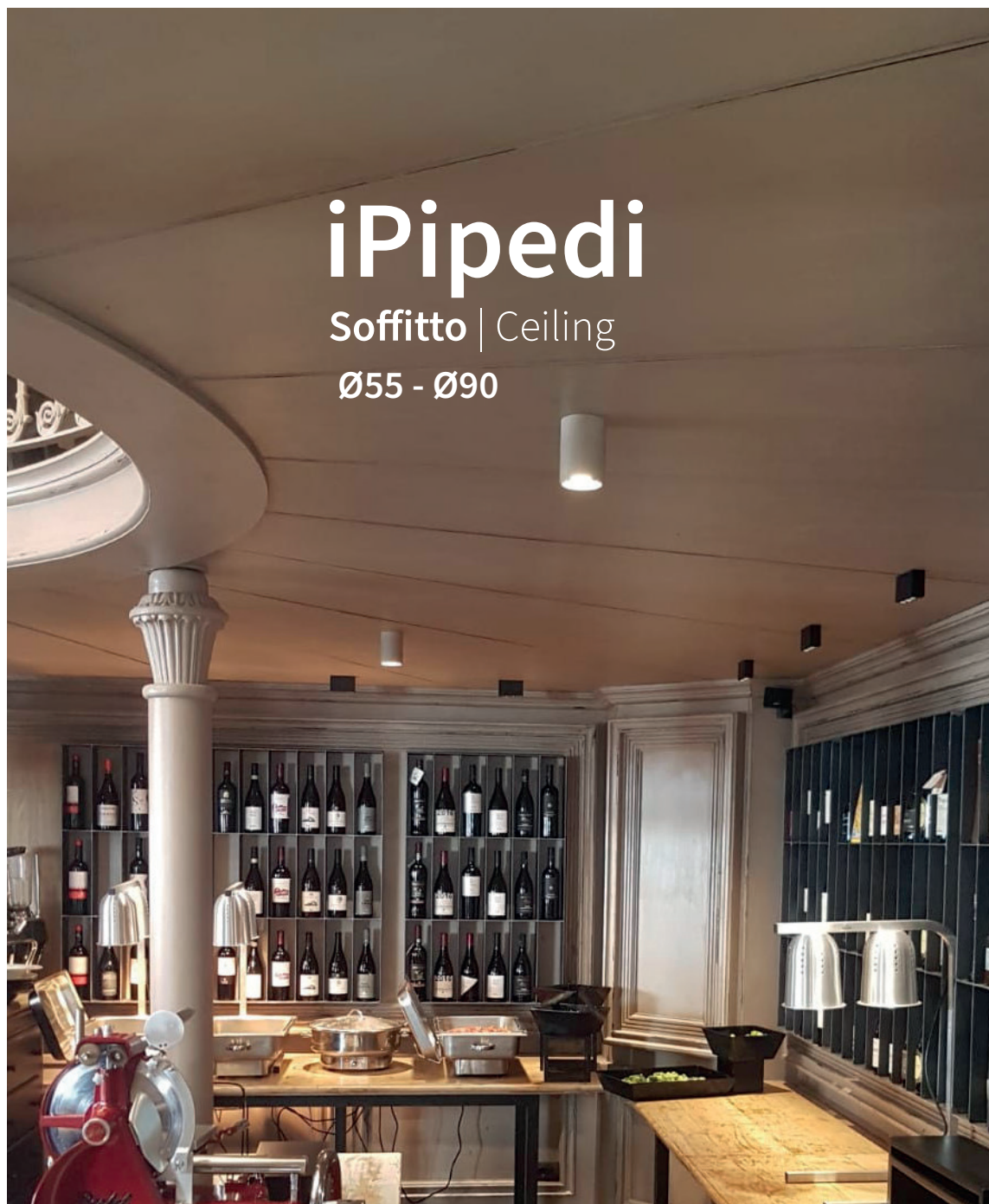

iPipedi

Soffitto | Ceiling

Ø55 - Ø90

Ø55

I-PIPEDI R55 H300

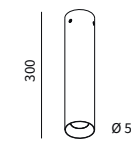

LED		Im product/beam 3000K		CODE		
W	Ø	H	Kg	F27°	W46°	
8	55	300	1,07	860	860	PP161.9 ●●●/##
LED		Im product/beam 3000K		CODE		
W	Ø	H	Kg	F27°	W46°	
12	55	300	1,07	1285	1289	PP013.9 ●●●/##
18	55	300	1,07	1575	1579	PP014.9 ●●●/##
GU10 LED 230V		CODE		UK CA CE		
W	Ø	H	Kg	PP013 /##		
1x max 50	55	300	1,04			

Ø90

I-PIPEDI R90 H90

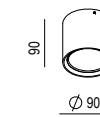
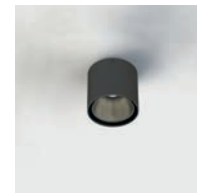

LED		Im product/beam 3000K		CODE		
W	Ø	H	Kg	F24°	W38°	
12	90	90	1,0	1289	-	PP165.9 ●●●/##
17	90	90	1,4	1827	1905	PP166.9 ●●●/##
24,3	90	90	1,4	2356	2430	PP167.9 ●●●/##

I-PIPEDI R90 H300

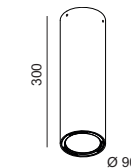

LED		Im product/beam 3000K		CODE		
W	Ø	H	Kg	F24°	W38°	
17	90	300		1827	1905	PP021.9 ●●●/##
24,3	90	300		2356	2430	PP022.9 ●●●/##
GU10 LED 230V		CODE		UK CA CE		
W	Ø	H	Kg	PP023 /##		
1x max 50	90	300				

Accessori - accessories: L085#.A: Anello ø85 - Lens with ring ø85

WALL - CEILING
SUSPENSION - FLOOR

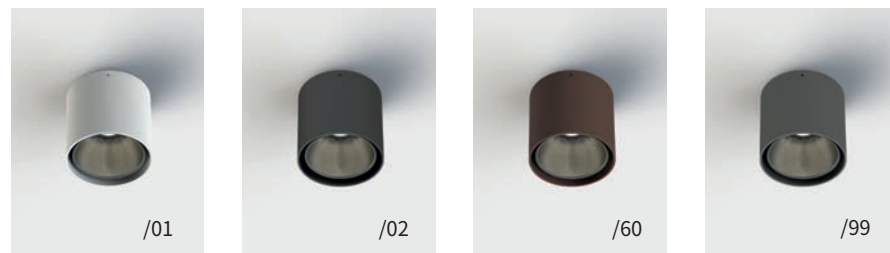

- **KELVIN**
 - 27 2700K
 - 30 3000K
 - 35 3500K
 - 40 4000K
- **FASCIO/BEAM**
 - F** Flood
 - W** Wide
- Per i gradi vedere in tabella - For degree check the table
- **DIMMABLE (OPTIONAL)**
 - **D** Dali
 - **DF** Dimm taglio di fase | dimm trailing /leading
- **FINITURA/FINISHING (PREMIUM AVAILABLE)**
 - **/01** bianco/white
 - **/02** nero/black
 - **/60** corten / corten
 - **/99** grafite/graphite

iPipedi

Parete | wall
Ø90

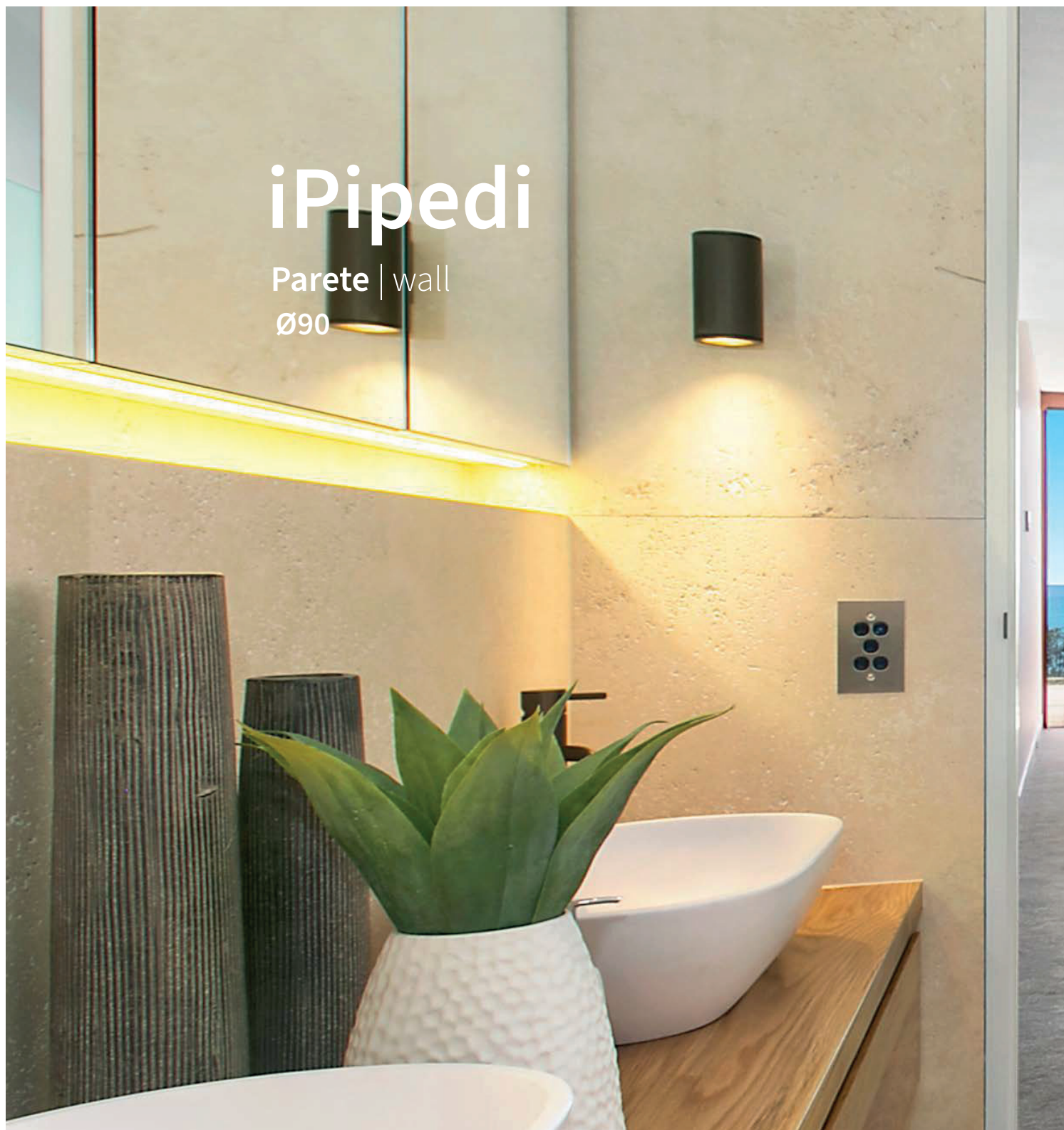

PARETE MONO EMISSIONE | SINGLE EMISSION WALL

Versione base con driver dimmerabile taglio di fase incluso | Trailing/leading edge dimmable included in Led base version.

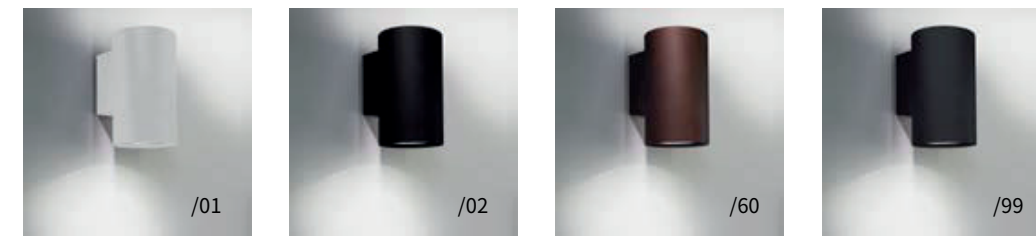

I-PIPEDI R90A H204

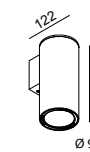

LED	W	Ø	H	lm product/beam 3000K	CODE
W	17	90	204	F24° W38° 1827 1905	PP221.9 ●●●/##

Accessori - Accessories: L085#.A: Anello ø85 + lente - Lens with rings ø85

PARETE BI EMISSIONE | DOUBLE EMISSION WALL

Versione base con driver dimmerabile taglio di fase incluso | Trailing/leading edge dimmable included in Led base version.

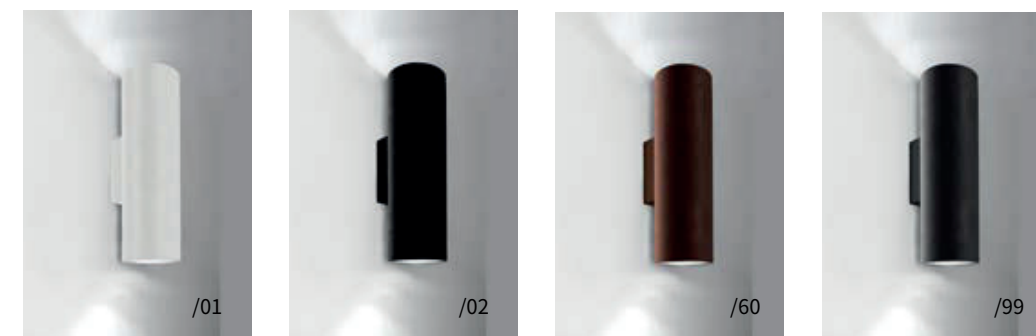

I-PIPEDI R90A2 H350

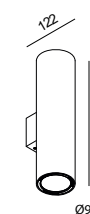

LED	W	Ø	H	lm product/beam 3000K	CODE
2x17	2x17	90	350	F24° W38° 3654 3810	PP321.9 ●●●/##

Accessori - Accessories: L085#.A: Anello ø85 + lente - Lens with rings ø85

WALL - CEILING
SUSPENSION - FLOOR

- KELVIN
- 27 2700K
- 30 3000K
- 35 3500K
- 40 4000K

- FASCIO/BEAM
- F Flood
- W Wide

Per i gradi vedere in tabella -
For degree check the table

DIMMABLE (OPTIONAL)

- D Dali

COMPOSIZIONE CODICE: xxx.x ●● /##

HOW TO CREATE THE CODE: F1000.827S/01

CODE
F1000.8 | ●● | /## finishing
base code kelvin beam

- /## FINITURA/FINISHING (PREMIUM AVAILABLE)
- /01 bianco/white
- /02 nero/black
- /60 corten /corten
- /99 grafite/graphite



IBRIDA



IBRIDA TERRA | FLOOR



/## FINITURA | FINISHING

- /01 bianco | white
- /02 nero | black
- /49 bronzo | bronze

/## FINITURA PREMIUM | PREMIUM FINISHING

- /81 oro rosa | rose gold
- /82 bronzo anticato | antique bronze
- /83 ottone brunito spazzolato/brushed burnished brass

LUCE INDIRETTA | INDIRECT LIGHT

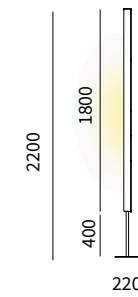

LED W	H	lm product/beam 3000K	CODE
17 indirect	2200	1590	IB000.9 ●●● /##

LUCE SPOT DIRETTA | DIRECT SPOT LIGHT

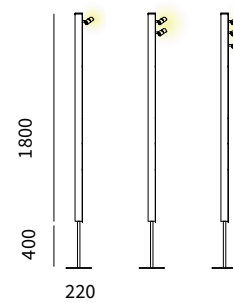

LED W	H	lm product/beam 3000K			CODE
		S19°	F28°	Z18°x38°	
8	2200	665	695	508	IB001.9 ●●● /##
16	2200	1330	1390	1016	IB002.9 ●●● /##
24	2200	1995	2085	1524	IB003.9 ●●● /##

Accessori - accessories: IB100: Modulo comandi + Command module

LUCE DIRETTA E INDIRETTA | DIRECT AND INDIRECT LIGHT

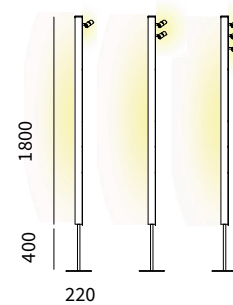

LED W	H	lm product/beam 3000K			CODE
		S19°	F28°	Z18°x38°	
17 indirect	2200	1590			IB011.9 ●●● /##
+ 1 spot 8 direct	2200	665	695	508	
17 indirect	2200	1590			
+ 2 spots 16 direct	2200	1330	1390	1016	IB012.9 ●●● /##
17 indirect	2200	1590			
+ 3 spots 24 direct	2200	1995	2085	1524	

Accessori - accessories: IB100: Modulo comandi + Command module

ACCESSORI / ACCESSORIES



MODULO COMANDI | COMMAND MODULE accensione/dimmerazione | switch on/off & dimmable

CODE
IB100 /##

VERSIONI DISPONIBILI/AVAILABLE VERSION

- **KELVIN**
 - 27 2700K
 - 30 3000K
 - 35 3500K
 - 40 4000K
- **FASCIO/BEAM**
 - S Spot
 - F Flood
 - Z Asymmetric
- **DIMMABLE (OPTIONAL)**
 - D Dali

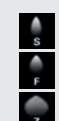

Per i gradi vedere in tabella - For degree check the table

COMPOSIZIONE CODICE: xxx.x ●●● /##
HOW TO CREATE THE CODE: **F1000.827SD/01**





IBRIDA PARETE | WALL

LUCE INDIRETTA |
INDIRECT LIGHT

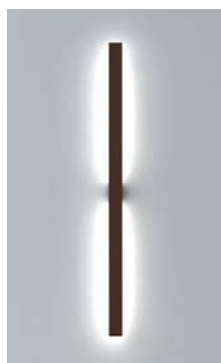

LUCE INDIRETTA | INDIRECT LIGHT

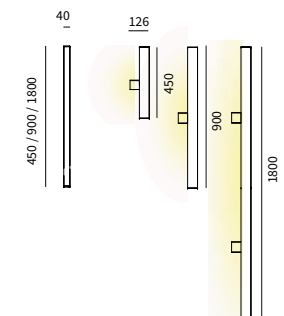

LED W	Lmm	Wmm	Hmm	lm product/beam 3000K	CODE
4,5	40	126	450	386	IB020.9 ●●●/##
9	40	126	900	835	IB021.9 ●●●/##
17	40	126	1800	1590	IB022.9 ●●●/##

LUCE SPOT DIRETTA |
DIRECT SPOT LIGHT



LUCE SPOT DIRETTA | DIRECT SPOT LIGHT

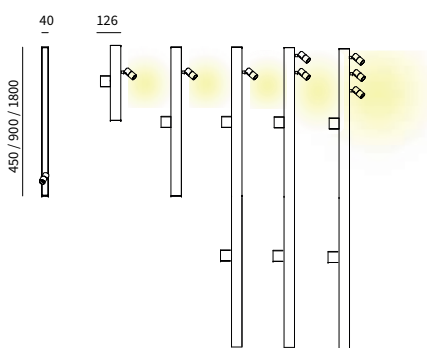

LED W	Lmm	Pmm	Hmm	lm product/beam 3000K	S19°	F28°	Z18°x38°	CODE
1 x 8	40	126	450	665	695	508		IB023.9 ●●●●/##
1 x 8	40	126	900	665	695	508		IB024.9 ●●●●/##
1 x 8	40	126	1800	665	695	508		IB025.9 ●●●●/##
2 x 8	40	126	1800	1330	1390	1016		IB026.9 ●●●●/##
3 x 8	40	126	1800	1995	2085	1524		IB027.9 ●●●●/##

Accessori - accessories: IB100: Modulo comandi + Command module

IBRIDA

Ibrida è una collezione di prodotti da parete o da terra che permette grande personalizzazione. Esiste proposta in moduli finiti, ma è tramite il sistema componibile che raggiunge la sua massima espressione. Caratterizzato da un profilo di alluminio che ospita una linea led che può essere installata sia diretta che indiretta, completo di diffusore in policarbonato opalino. Possibilità di aggiungere sino a 3 proiettori Focus per una luce diretta e puntuale. IP20

Hybrid is a wall or floor lamp collection that allows great customization. It exists in default modules, but it is through the modular system that reaches its maximum expression. Characterized by an aluminum profile that houses a led line both direct and indirect, complete with opal polycarbonate diffuser. Possibility to add spotlights Focus for a direct and punctual light. IP20



LUCE DIRETTA E INDIRETTA |
DIRECT AND INDIRECT LIGHT

LUCE DIRETTA E INDIRETTA |
DIRECT AND INDIRECT LIGHT

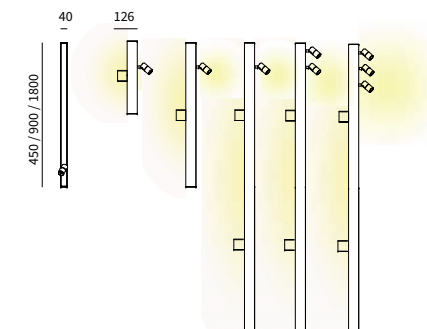

LED W	ø	H	lm product/beam 3000K	S19°	F28°	Z18°x38°	CODE
4,5 indirect			386				IB028.9 ●●●●/##
+ 1 spot x 8 direct	36	450	665	695	508		
9 indirect			835				
1 spot x 8 direct	36	900	665	695	508		IB029.9 ●●●●/##
17 indirect			1590				
+ 1 spot x 8 direct	36	1800	665	695	508		IB031.9 ●●●●/##
17 indirect			1590				
+ 2 spots 16 direct	36	1800	1330	1390	1016		IB032.9 ●●●●/##
17 indirect			1590				
+ 3 spots x 24 direct	36	1800	1995	2085	1524		IB033.9 ●●●●/##

Accessori - accessories: IB100: Modulo comandi + Command module

ACCESSORI / ACCESSORIES



MODULO COMANDI | COMMAND MODULE **accensione/dimmerazione** | switch on/off & dimmable

CODE
IB100 /##



/## FINITURA | FINISHING

- /01 bianco | white
- /02 nero | black
- /49 bronzo | bronze

/## FINITURA PREMIUM | PREMIUM FINISHING

- /81 oro rosa | rose gold
- /82 bronzo anticato | antique bronze
- /83 ottone brunito spazzolato/brushed burnished brass

VERSIONI DISPONIBILI/AVAILABLE VERSION

- **KELVIN**
- 27 2700K
- 30 3000K
- 35 3500K
- 40 4000K

- **FASCIO/BEAM**
- S** Spot
- F** Flood
- Z** Asymmetric

- **DIMMABLE (OPTIONAL)**
- D** Dali

COMPOSIZIONE CODICE: xxx.X ●●●/##
HOW TO CREATE THE CODE: **F1000.827SD/01**

CODE
F1000.8 ●●●/## — finishing
base code kelvin beam dimmable

Per i gradi vedere in tabella - For degree check the table

IBRIDA

SISTEMA | SYSTEM



WALL - CEILING
SUSPENSION - FLOOR



IBRIDA SYSTEMA | SYSTEM

PROFILO VUOTO COMPLETO DI ATTACCO A MURO / EMPTY PROFILE COMPLETE WITH WALL MOUNTS



Lmm	Kg	CODE
450	0,95	IB000.450 /##
900	2,00	IB000.900 /##
1800	2,60	IB000.1800 /##

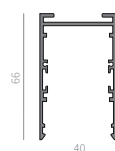

COPPIA DI TESTATE PER PROFILO / COUPLE OF CLOSURE HEADS



CODE
LT2403/##

REGELETTE

FILE SISTEMA REGLETTE LED 24W/M / 24W/M LED BATTEN



Alimentatore incluso | Driver included

LED 24W/m	Lmm	with opal diffuser	with microprismatic diffuser	CODE
12,8	560	721	964	R18FM0.8**
19,2	840	1082	1446	R18FM1.8
25,6	1120	1442	1928	R18FM2.8
32	1400	1803	2410	R18FM3.8
38,4	1680	2163	2892	R18FM4.8
44,8	1985	2524	3374	R18FM5.8
51,2	2240	2884	3856	R18FM6.8

* Note: Disponibile per le seguenti misure: 560, 1120, 1680, 2240mm. Gli apparecchi con temperatura di colore variabile (Tunable White) vengono forniti comprensivi di alimentatore DALI. Available for the following sizes: 560, 1120, 1680, 2240mm. The devices with variable color temperature (Tunable White) are supplied with integrated DALI power supply.
** Attenzione: non abbinare le reglette dimmerabili con codici R18FM0.8#D alle altre reglette di misura superiore perché potrebbero avere un comportamento differente durante la dimmerazione. | ** Attention: do not combine dimmable modules with codes R18FM0.8#D with other larger modules because they might have different dimming results.

FILE SISTEMA REGLETTE LED 32W/M / 32W/M LED BATTEN



Alimentatore incluso | Driver included

LED 32W/m	Lmm	with opal diffuser	with microprismatic diffuser	CODE
18	560	1119	1309	R18FH0.9
27	840	1679	1964	R18FH1.9
36	1120	2238	2618	R18FH2.9
45	1400	2798	3273	R18FH3.9
54	1680	3357	3927	R18FH4.9
63	1960	3917	4582	R18FH5.9
72	2240	4476	5236	R18FH6.9
81	2520	5036	5891	R18FH7.9
90	2800	5595	6545	R18FH8.9

○ 2700K non disponibile | 2700K not available

LINEA DI LUCE

LINEA DI LUCE DA 5 METRI/ LED LINE 5 METERS ROLL



Strip led ad alta efficienza con biadesivo e supporto di larghezza 8-12 mm su bobina da 5 metri, da alimentare con driver stabilizzati in tensione da 24Vdc. Classe di isolamento III. | High efficiency strip led with biadhesive and support of 8-12 mm wide on 5 meters roll. To be fed with 24Vdc voltage-stabilized driver. Insulation class III.

W/m	V	Led/m	lm/m	lm/W	CRI	IP	Lmm	CODE
4,8	24	120	620	129	90	20	5000	ST05.0.5
9,6	24	160	1220	127	90	20	5000	ST10.0.5
22	24	240	2700	123	90	20	5000	ST22.0.5
16,8	24	COB	1400	84	90	20	5000	ST22.TW.5

W/m	V	Led/m	lm/m	lm/W	CRI	IP	Lmm	CODE
9,6	24	160	1073	111	90	67	5000	ST10.0.5IP
16,8	24	200	1822	108	90	67	5000	ST18.0.5IP



W/m	V	Led/m	lm/m	type	cut	IP	Lmm	CODE
19,2	24	COB	640	RGBW 2700K	33,3	20	5000	ST19.2.RGBW.5
19,2	24	COB	655	RGBW 3000K	33,3	20	5000	ST20.RGBW.5
19,2	24	COB	540	RGBW 2700K	33,3	67	5000	ST19.RGBW.5IP
25+22,5	24	270	4100	RGB + White 3500K	55,4	20	5000	ST19.RGBW.5

DISSIPATORE DIRETTO PER STRIP LED/ DIRECT EMISSION HEATSINK FOR STRIP LED MOLLA SINGOLA PER DISSIPATORE/ SINGLE SPRING



molle incluse/ included springs	Lmm	CODE
n.2	1000	LTC1.1000/27
n.3	2000	LTC1.2000/27
n.3	3000	LTC1.3000/27
----	----	LTC1.misura/27



CODE
LTC1.ML

1 ogni metro / 1 every meter

In caso di tagli ordinare altre molle / Should you need to cut on-site, please order more springs

/## FINITURA | FINISHING

- /01 bianco | white
- /02 nero | black
- /49 bronzo | bronze

/## FINITURA PREMIUM | PREMIUM FINISHING

- /81 oro rosa | rose gold
- /82 bronzo antico | antique bronze
- /83 ottone brunito spazzolato/brushed burnished brass

DRIVERS VEDI | SEE P. 452

MODULI PROIETTORI / PROJECTORS MODULES



LED W	mA	lm product/beam 3000K			CODE
		S19°	F28°	Z18°x38°	
1x 8	700	665	695	508	IB041.9 ●●● /##
2 X 8	700	1330	1390	1016	IB042.9 ●●● /##
3 X 8	700	1995	2085	1524	IB043.9 ●●● /##

MODULO COMANDI | COMMAND MODULE accensione/dimmerazione | switch on/off & dimmable

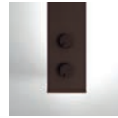

CODE
IB100 /##

DIFFUSORE IN POLICARBONATO OPALINO PER LUCE DIRETTA / OPAL DIRECT WHITE POLYCARBONATE DIFFUSER



Lmm	Kg	CODE
1000	0,16	LT239P.1000
2000	0,33	LT239P.2000
3000	0,50	LT239P.3000
-----		LT239P.misura

PIASTRA DI CHIUSURA IN ESTRUSO DI ALLUMINIO / EXTRUDED ALUMINIUM CLOSING COVER



Molle incluse/springs included	Lmm	CODE
n. 2	1000	F16.1000/##
n. 3	2000	F16.2000/##
n. 4	3000	F16.3000/##
-----		F16.misura/##

MOLLA PER PIASTRA DI CHIUSURA / SPRING FOR CLOSING COVER



CODE
F1.MLC

Una ogni 70 cm da ordinare solo in caso di tagli della piastra di chiusura | One every 70 cm. To be ordered in case of cut of the closing cover.

DIFFUSORE IN POLICARBONATO OPALINO INDIRETTO / OPAL INDIRECT WHITE POLYCARBONATE DIFFUSER



Lmm	Kg	CODE
1000	0,16	LT240P.1000
2000	0,33	LT240P.2000
3000	0,50	LT240P.3000
-----		LT240P.misura

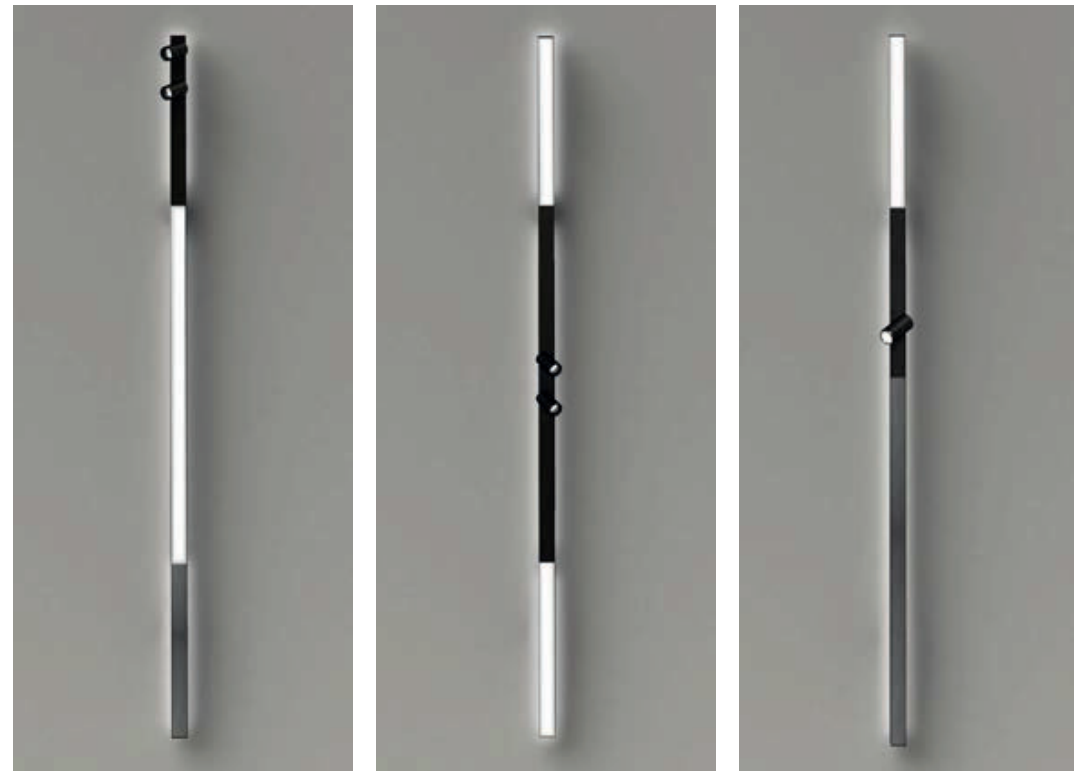

IBRIDA SISTEMA | SISTEM

WALL - CEILING
SUSPENSION - FLOOR

/## FINITURA | FINISHING

- /01 bianco | white
- /02 nero | black
- /49 bronzo | bronze

/## FINITURA PREMIUM | PREMIUM FINISHING

- /81 oro rosa | rose gold
- /82 bronzo antico | antique bronze
- /83 ottone brunito spazzolato/brushed burnished brass

/## FINITURA PIASTRA DI CHIUSURA | COVER FINISHING

- /01 bianco | white
- /02 nero | black
- /12 grigio | grey
- /49 bronzo | bronze

VERSIONI DISPONIBILI/AVAILABLE VERSION

- KELVIN
 - 27 2700K
 - 30 3000K
 - 35 3500K
 - 40 4000K
- FASCIO/BEAM
 - S Spot
 - F Flood
 - Z Asymmetric

Per i gradi vedere in tabella - For degree check the table

COMPOSIZIONE CODICE: xxx.x ●● /##

HOW TO CREATE THE CODE: F1000.827S /01



700 DRIVERS VEDI | SEE P. 452

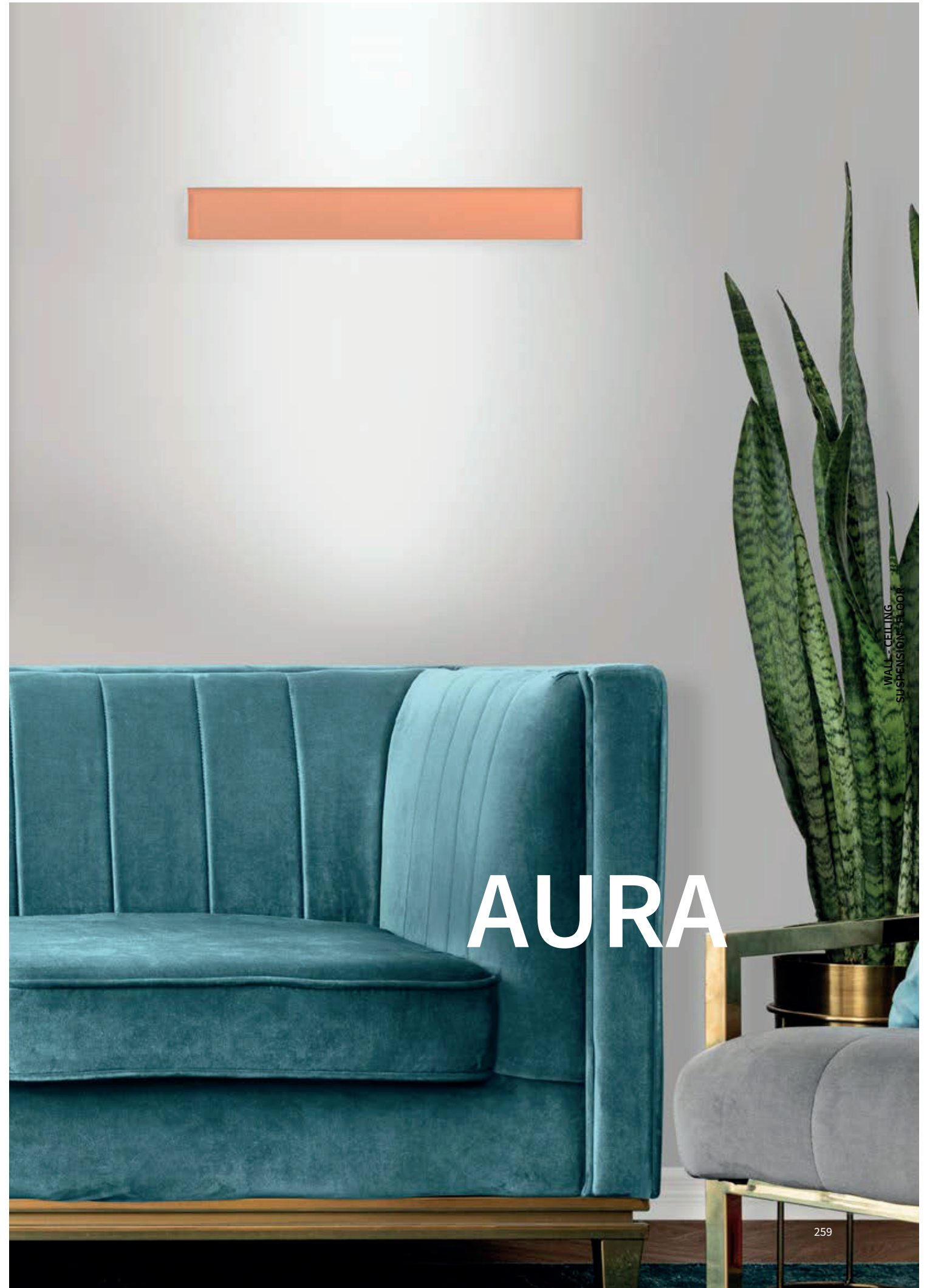
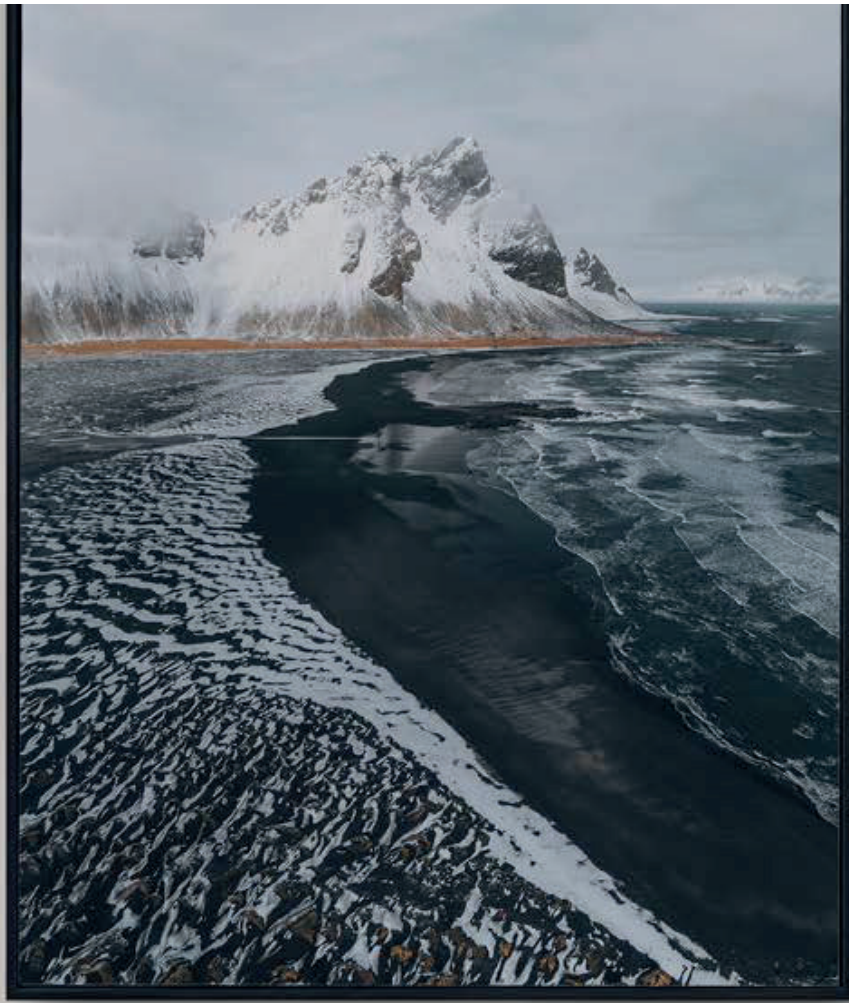

WALL - CEILING
SUSPENSION - FLOOR

AURA

AURA IN



Raffinata eleganza che coniuga funzionalità e discrezione Aura la nuova lampada da parete biemissione, dalle linee minimaliste, completa di luce lineare led. Apparecchio disponibile in due misure, 350 mm e 520 mm, in versione di colore bianco, nero e corten. Possibilità di essere personalizzato con la cover accessoria, disponibile nei colori bianco, nero, oro champagne, corten o grafite. Classe di protezione IP40. Disponibile anche in versione da esterno (Aura out).

Refined elegance that combines functionality and discretion Aura the new wall lamp biemissione, minimalist lines, complete with linear LED light. Luminaire available in two sizes, 350 mm and 520 mm, in white, black and corten. Possibility to be customized with the accessory cover, available in white, black, champagne gold, corten or graphite. Protection class IP40. Also available in outdoor version (Aura out).

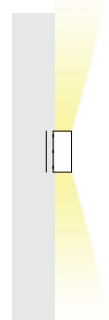

UK CONFORMITY ASSESSMENT E EUROPEAN CERTIFICATION / UK CONFORMITY ASSESMENT AND EUROPEAN CERTIFICATION



PRODOTTI COSTRUITI CON MATERIALE RICICLABILE / PRODUCTS MADE OF RECYCLABLE MATERIAL



GARANZIA DI 5 ANNI / 5-YEAR WARRANTY

KELVIN		
27		2700°K
30		3000°K
35		3500°K
40		4000°K

FINITURE STANDARD / STANDARD FINISHINGS		
/01		BIANCO/WHITE
/02		NERO/BLACK
/44C		ORO CHAMPAGNE/ GOLD
/60		CORTEN/CORTEN
/99		GRAFITE/GRAPHITE

FINITURE PREMIUM / PREMIUM FINISHINGS		
/81		ORO ROSA/ROSE GOLD
/82		BRONZO ANTICATO/ ANTIQUE BRONZE
/83		OTTONE BRUNITO SPAZZOLATO/ BRUSHED BURNISHED BRASS

AURA IN BIEMISSIONE

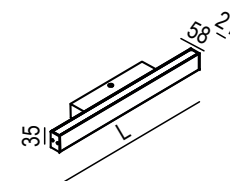

LED 24V	Lmm	lm product/beam 3000K	CODE
W 11	350	1203	AU00.9 ●● /##
LED	Lmm	lm product/beam 3000K	CODE
W 16	520	1800	AU01.9 ●● /##

ACCESSORI OPZIONALI / OPTIONAL ACCESSORIES

PANNELLO DI COPERTURA | COVER

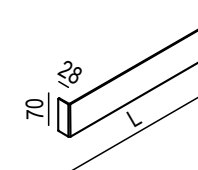
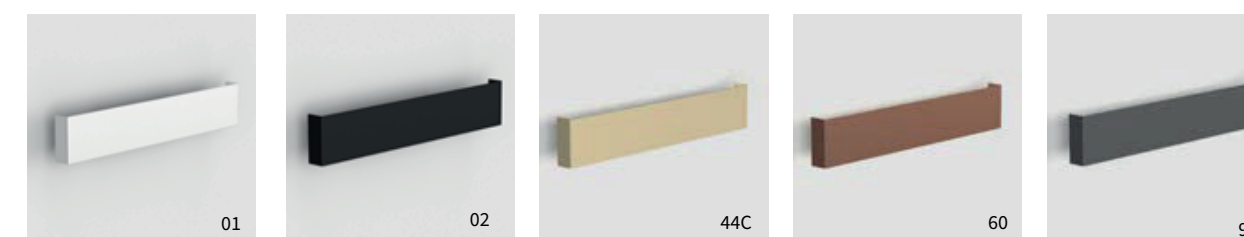

Lmm	CODE
393	AU00.C /##
Lmm	CODE
540	AU01.C /##

WALL - CEILING
SUSPENSION - FLOOR

● KELVIN	● DIMMABLE (OPTIONAL)
27 2700K	D Dali
30 3000K	
35 3500K	
40 4000K	

COMPOSIZIONE CODICE: xxx.X ●● /##
 HOW TO CREATE THE CODE: **F1000.8 27 D /01**

CODE
F1000.8 ● ● /## — finishing
 | | |
 base code kelvin dimmable

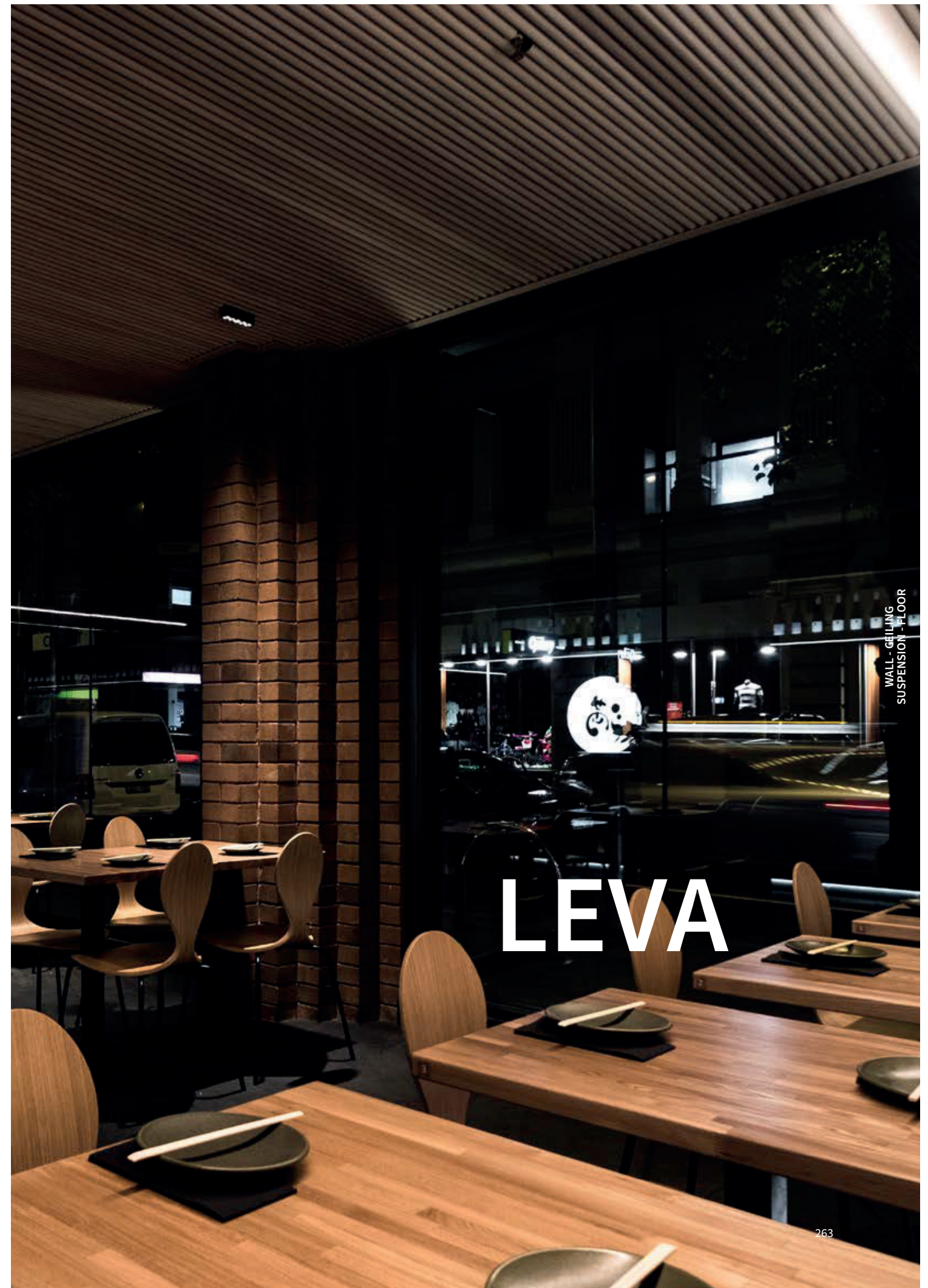

LEVA

LINEARI | LINEAR VERSION

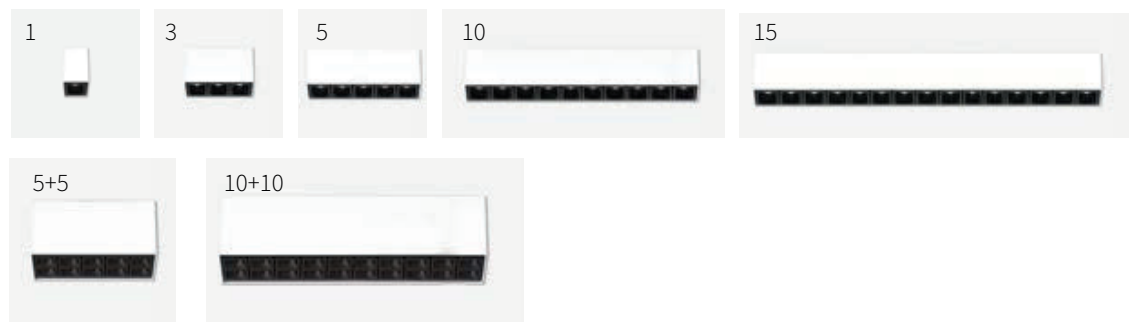

Collezione di apparecchi da incasso, fissi ed orientabili, con sorgenti LED Chip On Board integrate installabili a soffitto o parete. Corpo apparecchio in estruso di alluminio verniciato. Gruppi ottici antiabbagliamento completi di led chip on board (CRI>90) e lenti. Installabili anche nel container Minifile e File2 mediante apposite staffe. Ottiche spot, flood, wideflood ed ellittiche UGR<16. Alimentatori elettronici remoti on/off inclusi tranne che per i modelli ad una e tre luci. Grado di protezione IP20/IP43.

Collection of recessed luminaires, fixed and adjustable, with integrated Chip On Board LED sources. Ceiling or wall mounted. Luminaire body in painted extruded aluminum. Anti-glare optical groups complete with LED chip on board (CRI> 90) and lenses. They can also be installed in the Minifile and File2 containers using the special brackets as accessory. Spot, flood, wideflood and elliptical optics UGR <16. On/off remote electronic drivers included except for one and three light models. IP20/IP43.



UK CONFORMITY ASSESSMENT E EUROPEAN CERTIFICATION / UK CONFORMITY ASSESSTMENT AND EUROPEAN CERTIFICATION



PRODOTTI COSTRUITI CON MATERIALE RICICLABILE / PRODUCTS MADE OF RECYCLABLE MATERIAL



GARANZIA DI 5 ANNI / 5-YEAR WARRANTY

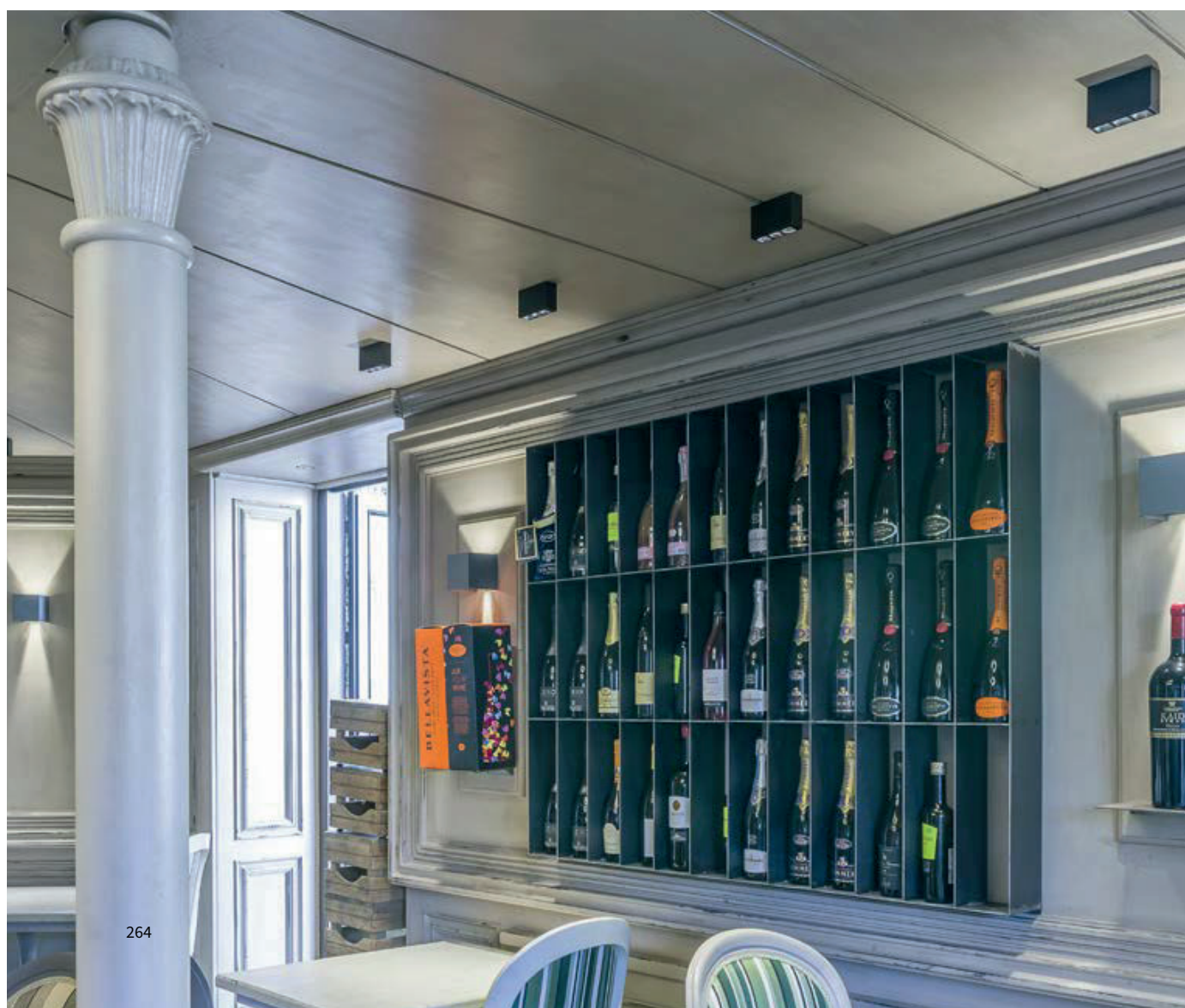

KELVIN

27		2700°K
30		3000°K
35		3500°K
40		4000°K

FASCIO/BEAM

	SPOT 20°
	FLOOD 32°
	WIDE 50°
	ASYMMETRIC 41°X18°

FINITURE STANDARD /STANDARD FINISHINGS

/01		TELAIO BIANCO OTTICA NERA/ WHITE FRAME BLACK OPTIC
/02		TELAIO NERO OTTICA NERA/ BLACK FRAME BLACK OPTIC
/41		TELAIO BIANCO OTTICA BIANCA/ WHITE FRAME WHITE OPTIC
/42		TELAIO NERO OTTICA ORO/ BLACK FRAME GOLD OPTIC

TW



Tunable White 2700 – 5000°K
La tecnologia Tunable White consente di controllare la temperatura di colore delle sorgenti luminose permettendo di scegliere quella più adatta tra luce bianca calda e fredda. / Tunable White technology allows you to control the color temperature of light sources allowing you to choose the most suitable between warm and cold white light.

FINITURE PREMIUM /PREMIUM FINISHINGS

81-ORO ROSA/ PINK GOLD	82-BRONZO ANTICATO/ ANTIQUE BRONZE	83-OTTONE BRUNITO SPAZZOLATO/BRUSHED BURNISHED BRASS

CURVE FOTOMETRICHE/PHOTOMETRIC DATA

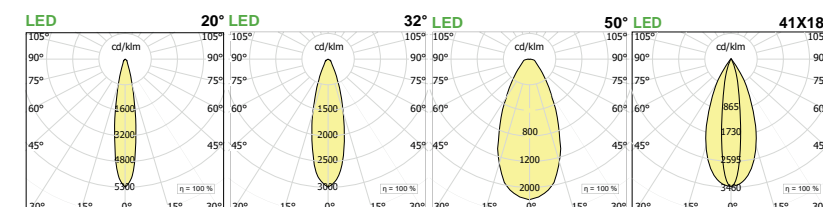



VERSIONI ALIMENTATORI ESCLUSI-POWER SUPPLIER NOT INCLUDED

LEVA SOFFITTO/PARETE 1 WALL/CEILING



LED		Dim.				H	Kg	lm prod./beam 3000K				CODE	
W	mA	20°	32°	50°	41°x18°			20°	32°	50°	41°x18°		
2,2	700	32x40	62	0.16	200	186	166	175	LV021.9				●●●/##

Da completare con alimentatore da installare remoto in scatola di derivazione. Per installazione in Container Minifile ordinare n.1 LTM210 staffa per fissaggio modulo luminoso all'interno della cassaforma. | To be completed with power supply to be installed in a remote junction box. To install in Container Minifile order n.1 LTM210 single bracket to fix the lighting module within the wallbox.

LEVA SOFFITTO/PARETE 3 WALL/CEILING



LED		Dim.				H	Kg	lm prod./beam 3000K				CODE	
W	mA	20°	32°	50°	41°x18°			20°	32°	50°	41°x18°		
6,6	700	32x100	62	0.26	601	558	496	526	LV026.9				●●●/##

Da completare con alimentatore da installare remoto in scatola di derivazione. Per installazione in Container Minifile ordinare n.2 LTM210 staffa per fissaggio modulo luminoso all'interno della cassaforma. | To be completed with power supply to be installed in a remote junction box. To install in Container Minifile order n.2 LTM210 single bracket to fix the lighting module within the wallbox.

VERSIONI ALIMENTATORI INCLUSI-INTEGRATED POWER SUPPLIES (ON/OFF)

LEVA SOFFITTO/PARETE 5 WALL/CEILING

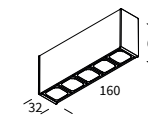

LED		Dim.				H	Kg	lm prod./beam 3000K				CODE	
W	mA	20°	32°	50°	41°x18°			20°	32°	50°	41°x18°		
11		32x160	62	0.34	1002	931	828	877	LV027.9				●●●/##

Per installazione in Container Minifile ordinare n.2 LTM210 staffa per fissaggio modulo luminoso all'interno della cassaforma. To install in Container Minifile order n.2 LTM210 single bracket to fix the lighting module within the wallbox.

LEVA SOFFITTO/PARETE 10 WALL/CEILING

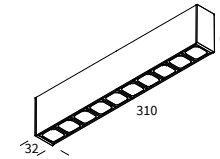

LED		Dim.				H	Kg	lm product/beam 3000K				CODE	
W	mA	20°	32°	50°	41°x18°			20°	32°	50°	41°x18°		
22		32x310	62	0.66	2004	1862	1656	1754	LV028.9				●●●/##

Per installazione in Container Minifile ordinare n.2 LTM210 staffa per fissaggio modulo luminoso all'interno della cassaforma. To install in Container Minifile order n.2 LTM210 single bracket to fix the lighting module within the wallbox.

LEVA SOFFITTO/PARETE 15 WALL/CEILING

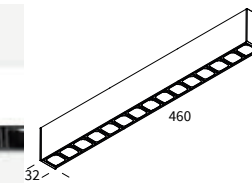

LED		Dim.				H	Kg	lm product/beam 3000K				CODE	
W	mA	20°	32°	50°	41°x18°			20°	32°	50°	41°x18°		
33		32x460	62	0.91	3006	2793	2484	2631	LV029.9				●●●/##

Per installazione in Container Minifile ordinare n.2 LTM210 staffa per fissaggio modulo luminoso all'interno della cassaforma. | To install in Container Minifile order n.2 LTM210 single bracket to fix the lighting module within the wallbox.

LEVA SOFFITTO/PARETE 5+5 WALL/CEILING

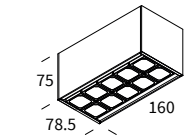

LED		Dim.				H	Kg	lm prod./beam 3000K				CODE	
W	mA	20°	32°	50°				20°	32°	50°			
22		78.5x160	75	0.88	2000	1862	1656		LV083.9				●●●/##

Per installazione in Container File 2 ordinare n.2 LT2891 staffa per fissaggio modulo luminoso all'interno della cassaforma. To install in Container File 2 order n.2 LT2891 single bracket to fix the lighting module within the wallbox.

LEVA SOFFITTO/PARETE 10+10 WALL/CEILING

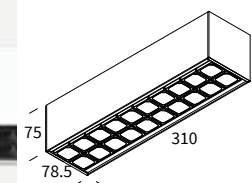

LED		Dim.				H	Kg	lm prod./beam 3000K				CODE	
W	mA	20°	32°	50°				20°	32°	50°			
44		78.5x310	75	1,2	4000	3724	3312		LV084.9				●●●/##

Per installazione in Container File 2 ordinare n.2 LT2891 staffa per fissaggio modulo luminoso all'interno della cassaforma. To install in Container File 2 order n.2 LT2891 single bracket to fix the lighting module within the wallbox.

VERSIONI DISPONIBILI/AVAILABLE VERSION

● KELVIN	● FASCIO/BEAM	○ FASCIO/BEAM
27 2700K	S Spot	S Spot
30 3000K	F Flood	F Flood
35 3500K	W Wide	W Wide
40 4000K	Z Asymmetric	
TW Tunable white	● DIMMABLE (OPTIONAL)	

Per i gradi vedere in tabella - For degree check the table

D Dali

/## FINITURA/FINISHING

☐	/01 telaio bianco, ottica nera white frame, black optic
☐	/02 telaio nero, ottica nera black frame, black optic
☐	/41 telaio bianco, ottica bianca white frame, white optic
☐	/42 telaio nero, ottica oro black frame, gold optic



FILE 2

COMPLEMENTI

WALL - CEILING
SUSPENSION - FLOOR

FILE 2 COMPLEMENTI

Apparecchi a soffitto per illuminazione diretta, completi di sorgenti LED professionali o per lampade GU10 LED. Corpo quadrato o rettangolare in lamiera di acciaio verniciata. Completi di staffa per fissaggio a soffitto. Sugeriti in abbinamento a moduli finiti e profili File2 oppure all'interno del Containers File2.

Ceiling fixtures for direct lighting, complete with professional LED sources or for GU10 LED lamps. Square or rectangular body in painted steel. Complete with bracket for ceiling fixing. Recommended in combination with finished modules and File2 profiles or inside the File2 Containers.



UK CONFORMITY ASSESSMENT E EUROPEAN CERTIFICATION / UK CONFORMITY ASSESSTMENT AND EUROPEAN CERTIFICATION



PRODOTTI COSTRUITI CON MATERIALE RICICLABILE / PRODUCTS MADE OF RECYCLABLE MATERIAL



GARANZIA DI 5 ANNI / 5-YEAR WARRANTY



VERSIONI CON SORGENTE LED GU10 DISPONIBILI / GU10 LIGHT SOURCE VERSION AVAILABLE

KELVIN		
27		2700°K
30		3000°K
35		3500°K
40		4000°K

FASCIO/BEAM		
F		FLOOD
W		WIDE

FINITURE STANDARD / STANDARD FINISHINGS

/01		BIANCO/WHITE
/02		NERO/BLACK
/49		BRONZO/BRONZE

FINITURE PREMIUM / PREMIUM FINISHINGS

/81		ORO ROSA/ROSE GOLD
/82		BRONZO ANTICATO/ANTIQUE BRONZE
/83		OTTONE BRUNITO SPAZZOLATO/BRUSHED BURNISHED BRASS

FILE2 COMPLEMENTI 1

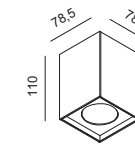

FILE2 COMPLEMENTI 2

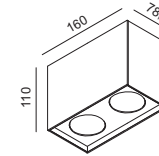

LED W	Dim.	H	lm product/beam 3000K F27° W46°	CODE
8	78x78	110	860 860	LT2680.9 ●●/##
12	78x78	110	1285 1285	LT2681.9 ●●/##
GU10 LED 230V W	Dim.	H	CODE	
50	78x78	110	LT2660 /##	

LED W	Dim.	H	lm product/beam 3000K F24° W36°	CODE
16	78x160	110	660 900	LT2661.9 ●●/##
GU10 LED 230V W	Dim.	H	CODE	
100	78x160	110	LT2661 /##	



VERSIONI DISPONIBILI/AVAILABLE VERSION

● KELVIN	● FASCIO/BEAM
27 2700K	F Flood 24°
30 3000K	W Wide 36°
35 3500K	
40 4000K	

/## FINITURA/FINISHING

	/01 bianco white
	/02 nero black
	/49 bronzo/bronze

COMPOSIZIONE CODICE: xxx.x ●●/##
HOW TO CREATE THE CODE: F1000.827S/01

CODE				
F1000.8	●	●	/##	— finishing
base code	kelvin	beam		

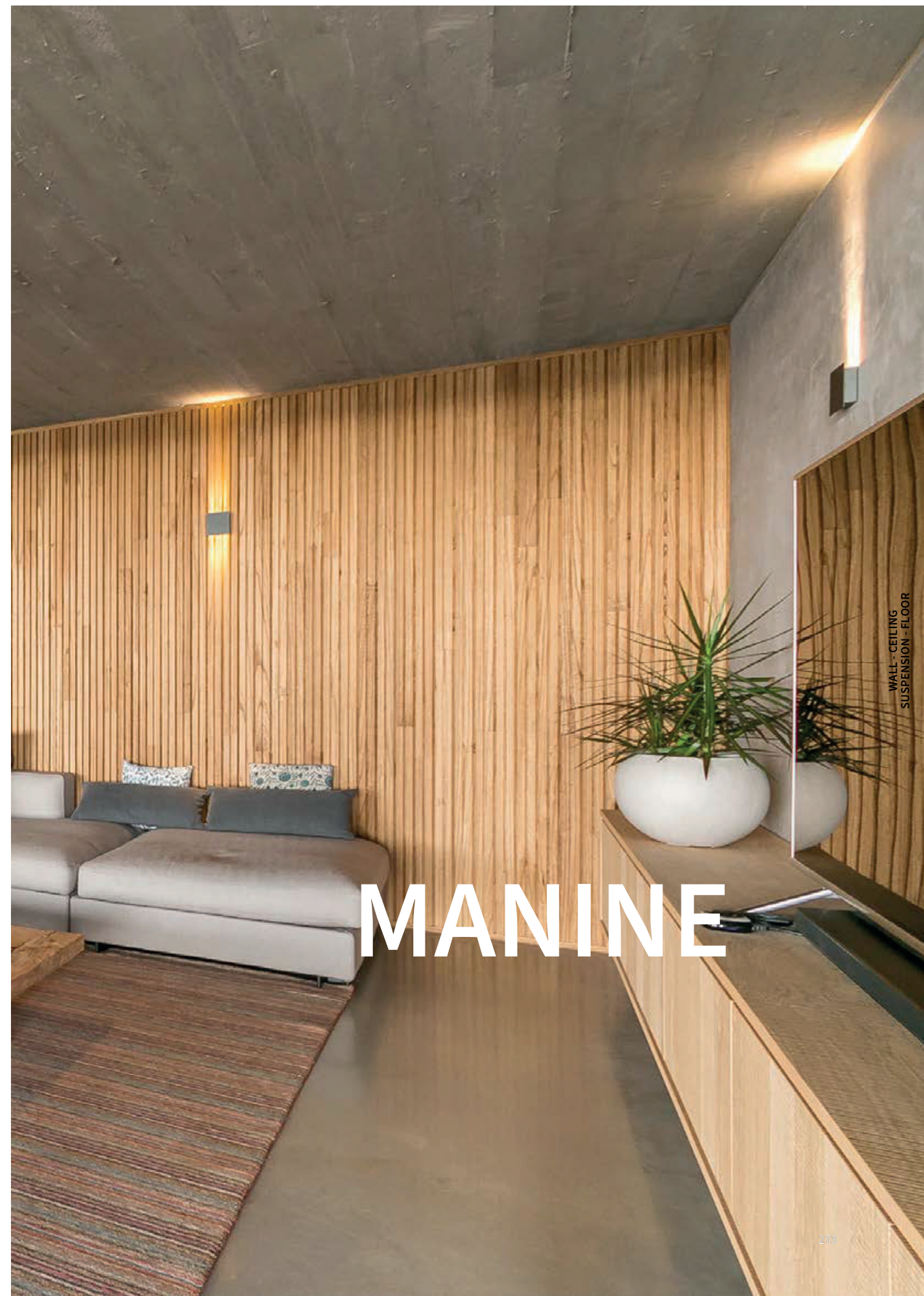

WALL - CEILING
SUSPENSION - FLOOR

MANINE

MANINE



Apparecchi a parete mono o biemissione per illuminazione d'accento e di pareti ed angoli. Gruppo ottico completo di sorgenti LED professionali, con alimentazione integrata. Disponibili in versione ad angolo interno 90°, ad angolo esterno 270° oppure piatta. Corpo in metallo finitura verniciata. Grado di protezione IP40.

Single or double emission wall mounted luminaires for wall enhancing and corner lighting. Optical unit complete with professional LED sources, with integrated power supply. Available in 90° internal angle, 270° external angle or flat version. Painted finish metal body. IP40.

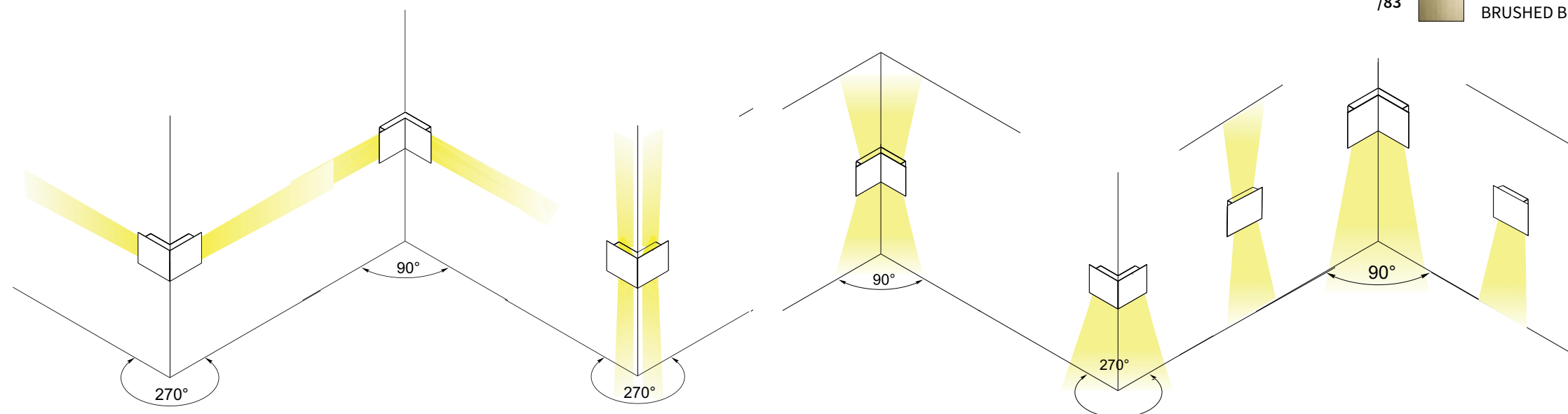

UK CONFORMITY ASSESSMENT E EUROPEAN CERTIFICATION / UK CONFORMITY ASSESSTMENT AND EUROPEAN CERTIFICATION



PRODOTTI COSTRUITI CON MATERIALE RICICLABILE / PRODUCTS MADE OF RECYCLABLE MATERIAL



GARANZIA DI 5 ANNI / 5-YEAR WARRANTY



FASCIO STRETTO / NARROW BEAM



FASCIO LARGO / WIDE BEAM

KELVIN

27		2700°K
30		3000°K
35		3500°K
40		4000°K

FASCIO/BEAM

	SPOT
	DIFFUSED

FINITURE STANDARD /STANDARD FINISHINGS

/01		BIANCO/WHITE
/02		NERO/BLACK
/60		CORTEN/CORTEN

FINITURE PREMIUM /PREMIUM FINISHINGS

/81		ORO ROSA/ROSE GOLD
/82		BRONZO ANTICATO/ ANTIQUÉ BRONZE
/83		OTTONE BRUNITO SPAZZOLATO/ BRUSHED BURNISHED BRASS

SPOT

MANINE 90 ANGOLO INTERNO | INTERNAL ANGLE

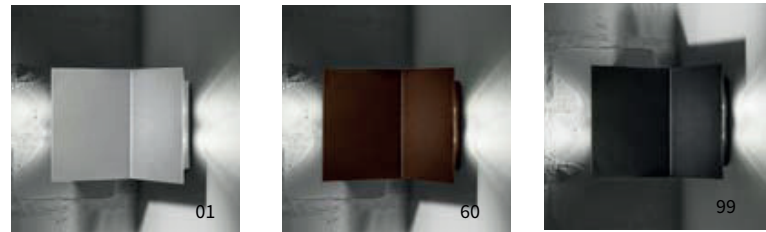
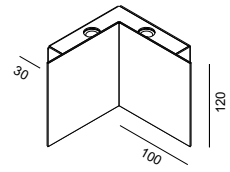

BIEMISSIONE ORIZZONTALE - HORIZONTAL DOUBLE EMISSION

LED	W	Kg	lm product/beam/3000K	CODE
2x3	0,82	368	S14°	LT7100.8 ● S/##

BIEMISSIONE VERTICALE - VERTICAL DOUBLE EMISSION

LED	W	Kg	lm product/beam/3000K	CODE
2x3	0,82	368	S14°	LT7104.8 ● S/##

MONOEMISSIONE VERTICALE - VERTICAL SINGLE EMISSION

LED	W	Kg	lm product/beam/3000K	CODE
3	0,78	184	S14°	LT7102.8 ● S/##

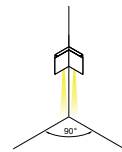
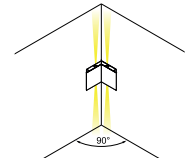
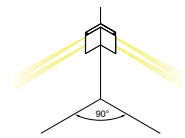

MANINE 270 ANGOLO ESTERNO | EXTERNAL ANGLE

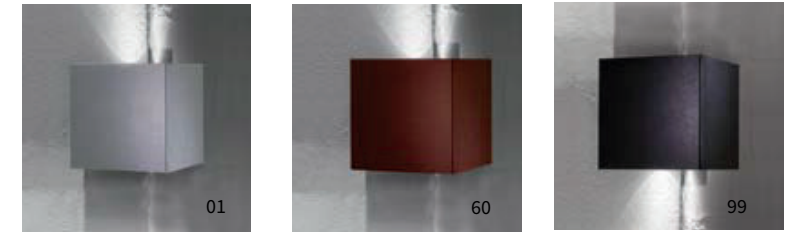
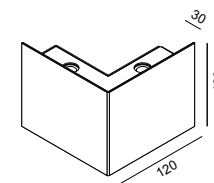

BIEMISSIONE ORIZZONTALE - HORIZONTAL DOUBLE EMISSION

LED	W	Kg	lm product/beam/3000K	CODE
2x3	0,82	368	S14°	LT7000.8 ● S/##

BIEMISSIONE VERTICALE - VERTICAL DOUBLE EMISSION

LED	W	Kg	lm product/beam/3000K	CODE
2x3	0,82	368	S14°	LT7004.8 ● S/##

MONOEMISSIONE VERTICALE - VERTICAL SINGLE EMISSION

LED	W	Kg	lm product/beam/3000K	CODE
3	0,78	184	S14°	LT7002.8 ● S/##

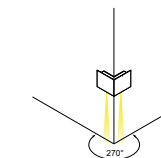
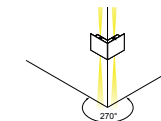
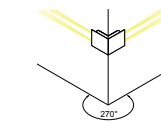

MANINE PARETE | WALL

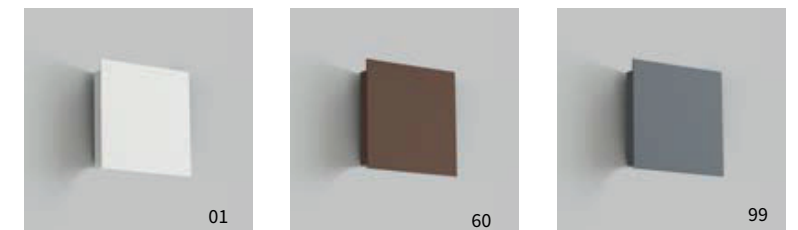
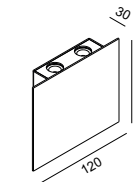

SINGLE EMISSION

LED	W	Kg	lm product/beam/3000K	CODE
3	0,52	184	S14°	LT7200.8 ● S/##

Posizionabile anche in orizzontale. | possible to be installed horizontally

DOUBLE EMISSION

LED	W	Kg	lm product/beam/3000K	CODE
2x3	0,56	368	S14°	LT7300.8 ● S/##

VERSIONI DISPONIBILI/AVAILABLE VERSION

- **KELVIN**
- 27 2700K
- 30 3000K
- 35 3500K
- 40 4000K
- **FASCIO/BEAM**
- S Spot 14°

/## FINITURA/FINISHING

- 01 bianco / white
- 60 corten / corten
- 99 grafe / graphite

COMPOSIZIONE CODICE: xxx.x●●/##
HOW TO CREATE THE CODE: F1000.827S/01

CODE
F1000.8 ● ● /## — finishing
base code kelvin beam

CURVE FOTOMETRICHE/ PHOTOMETRIC DATA

SPOT VERSION

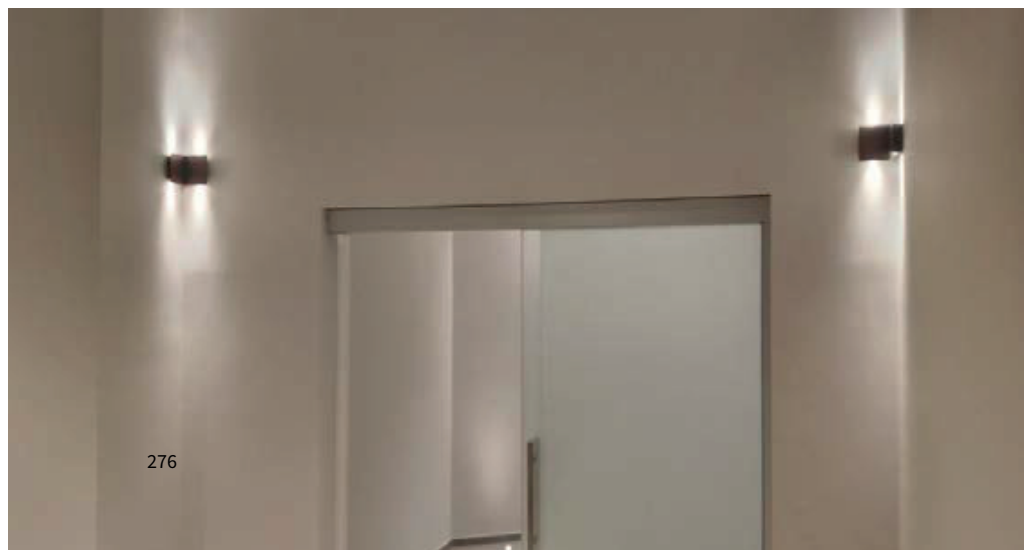
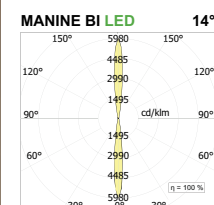
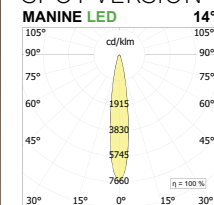

DIFFUSED

MANINE 90 ANGOLO INTERNO | INTERNAL ANGLE

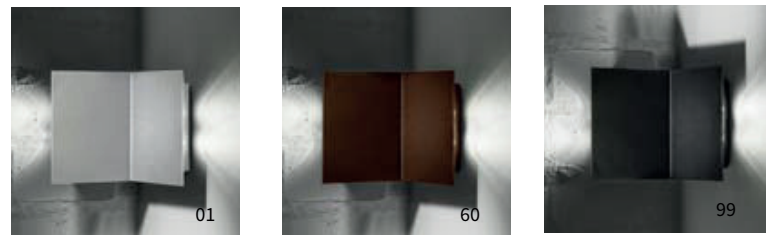
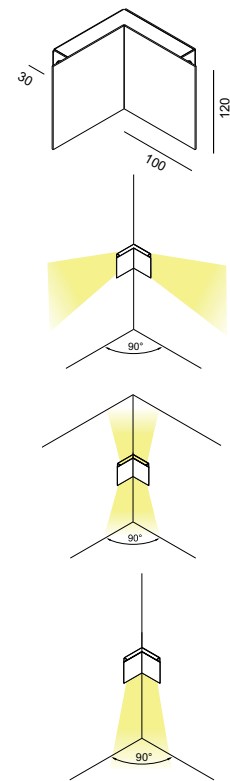

BIEMISSIONE ORIZZONTALE HORIZONTAL DOUBLE EMISSION

LED	W	Kg	lm product/beam/3000K	CODE
2x13	0,82	1380	30x100°	MN003.9 ● /##

BIEMISSIONE VERTICALE VERTICAL DOUBLE EMISSION

LED	W	Kg	lm product/beam/3000K	CODE
2x13	0,82	1380	30x100°	MN004.9 ● /##

MONOEMISSIONE VERTICALE VERTICAL SINGLE EMISSION

LED	W	Kg	lm product/beam/3000K	CODE
13	0,78	690	30x100°	MN005.9 ● /##

MANINE PARETE | WALL

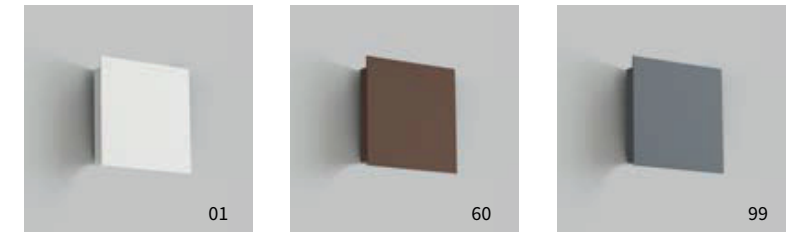
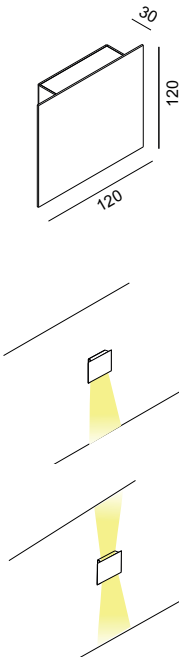

SINGLE EMISSION

LED	W	Kg	lm product/beam/3000K	CODE
13	0,52	690	30x100°	MN006.9 ● /##

Posizionabile anche in orizzontale. | possible to be installed horizontally

DOUBLE EMISSION

LED	W	Kg	lm product/beam/3000K	CODE
2x13	0,56	1380	30x100°	MN007.9 ● /##

MANINE 270 ANGOLO ESTERNO | EXTERNAL ANGLE

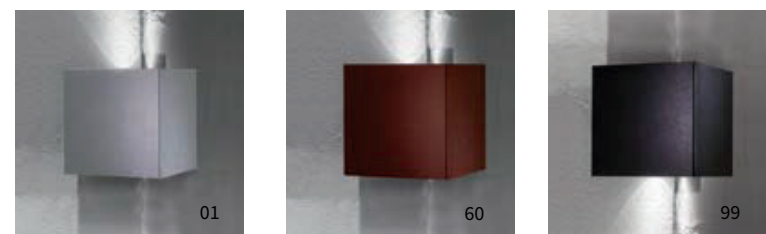
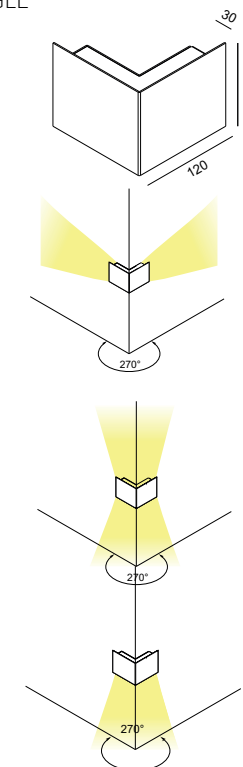

BIEMISSIONE ORIZZONTALE HORIZONTAL DOUBLE EMISSION

LED	W	Kg	lm product/beam/3000K	CODE
2x13	0,82	1380	30x100°	MN000.9 ● /##

BIEMISSIONE VERTICALE VERTICAL DOUBLE EMISSION

LED	W	Kg	lm product/beam/3000K	CODE
2x13	0,82	1380	30x100°	MN001.9 ● /##

MONOEMISSIONE VERTICALE VERTICAL SINGLE EMISSION

LED	W	Kg	lm product/beam/3000K	CODE
13	0,78	690	30x100°	MN002.9 ● /##



CURVE FOTOMETRICHE/ PHOTOMETRIC DATA DIFFUSED VERSION

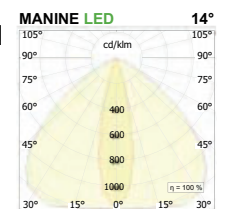

VERSIONI DISPONIBILI/AVAILABLE VERSION

- KELVIN
- 27 2700K
- 30 3000K
- 35 3500K
- 40 4000K

/## FINITURA/FINISHING

- 01 bianco | white
- 60 corten | corten
- 99 grafite | graphite

COMPOSIZIONE CODICE: xxx.X ● /##

HOW TO CREATE THE CODE: F1000.8 27 /01

CODE
F1000.8 ● /## — finishing
 base code kelvin

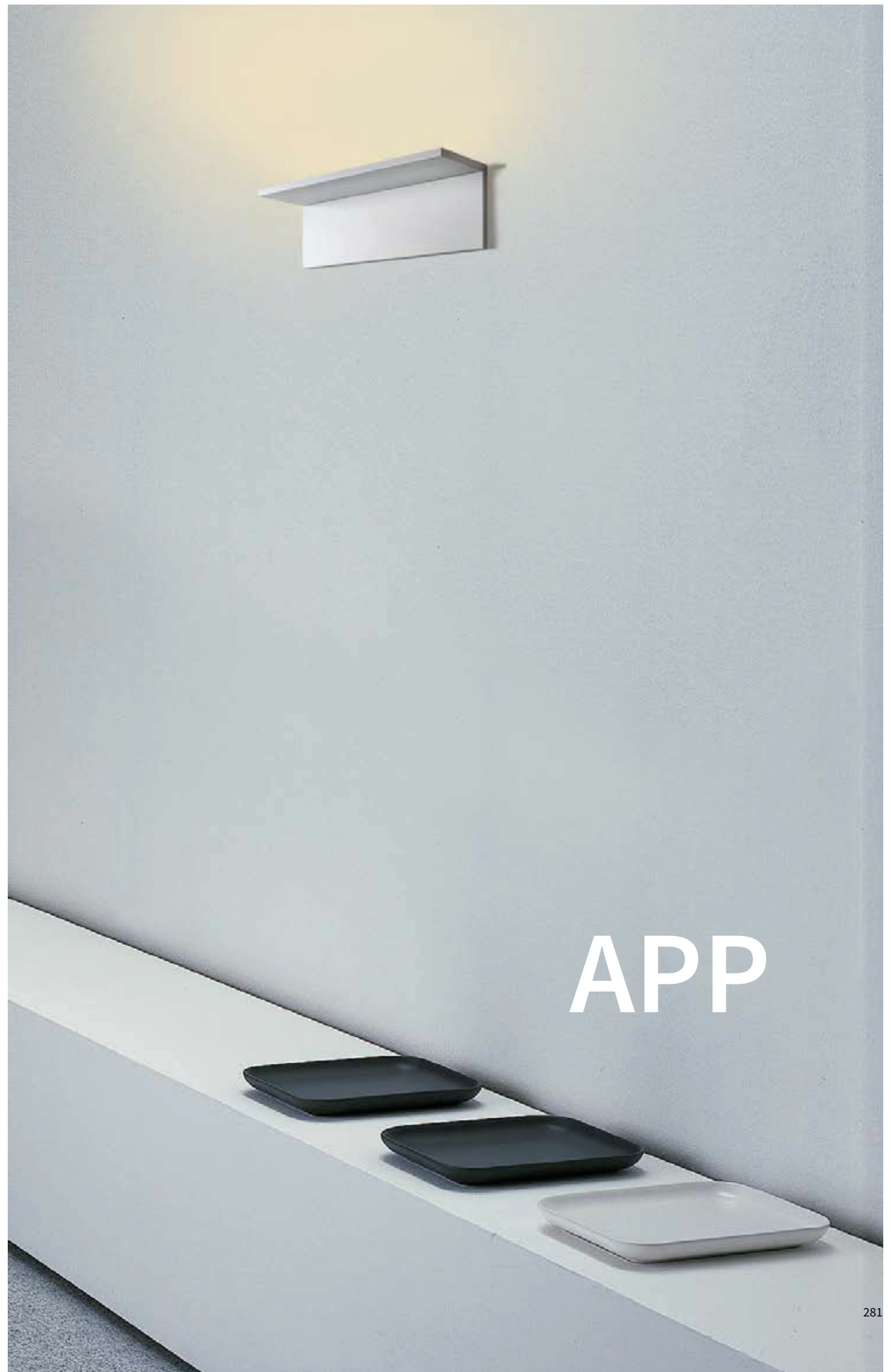

APP

APP

Applique architeturale a sorgente LED lineare. Caratterizzata da dimensioni ultraminimali, installata diventa parte integrante dell'architettura. App-line, una piccola mensola con emissione luminosa indiretta. App-eal, una "L", con emissione luminosa indiretta. Corpo in alluminio pieno lavorato, finitura verniciata. Gruppo ottico completo di schermo di protezione satinato. Grado di protezione IP40.

Architectural wall light with linear LED light source. Characterized by ultraminimal dimensions, installed it becomes an integral part of the architecture. App-line, a small shelf with indirect light emission. App-eal, an "L" with indirect light emission. Full machined aluminum body, painted finish. Optical unit complete with satin protection screen. IP40.



UK CONFORMITY ASSESSMENT E EUROPEAN CERTIFICATION / UK CONFORMITY ASSESMENT AND EUROPEAN CERTIFICATION



PRODOTTI COSTRUITI CON MATERIALE RICICLABILE / PRODUCTS MADE OF RECYCLABLE MATERIAL



GARANZIA DI 5 ANNI / 5-YEAR WARRANTY

FINITURE/FINISHINGS



01-BIANCO/WHITE



02- NERO/BLACK



49- BRONZO/BRONZE

FINITURE PREMIUM /PREMIUM FINISHINGS



81-ORO ROSA/
PINK GOLD



82-BRONZO
ANTICATO/
ANTIQUÉ
BRONZE



83-OTTONE BRUNITO
SPAZZOLATO/BRUSHED
BURNISHED BRASS

CURVE FOTOMETRICHE/PHOTOMETRIC DATA

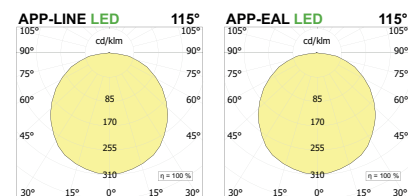

VERSIONI DISPONIBILI/AVAILABLE VERSION

- KELVIN
- 27 2700K
- 30 3000K
- 35 3500K
- 40 4000K

FASCIO/BEAM

115°

- /01 bianco | white
- /02 nero | black
- /49 bronzo | bronze

COMPOSIZIONE CODICE: xxx.x ● /##

HOW TO CREATE THE CODE: F1000.827/01

CODE
F1000.8 ● /## — finishing
base code kelvin

400 DRIVERS VEDI | SEE P. 452

APP-LINE 1

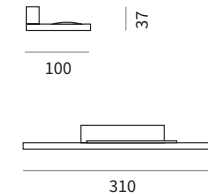

VERSIONE 230V

LED	Dim.	H	Kg	k	lm product/beam 3000K	CODE
12	100x310	37	1	3000	940	APS01/##
12	100x310	37	1	4000	960	APS02/##

Alimentatore dimmerabile a taglio di fase incluso per dimmer dedicati tipo Vimar EvoEikon od equivalenti. Phase cut driver, to be used with Vimar EvoEikon or equivalent dimmers, included

VERSIONE 400 mA

LED	Dim.	H	Kg	k	lm product/beam 3000K	CODE
10	100x310	37	1	1300		APS03.9 ● /##

Alimentatore non incluso, possibilità di abbinare driver On- off, Dali touch & Dimm, Dali 1-10V. Driver not included, it can be used with On- off, Dali touch & Dimm, Dali 1-10V dimmers.

APP-LINE 2

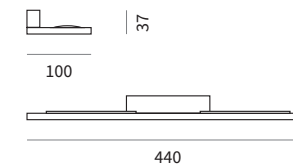

VERSIONE 230V

LED	Dim.	H	Kg	K	lm product/beam 3000K	CODE
23	100x440	37	1,30	3000	1880	APSB1/##
23	100x440	37	1,30	4000	1920	APSB2/##

Alimentatore dimmerabile a taglio di fase incluso per dimmer dedicati tipo Vimar EvoEikon od equivalenti. Phase cut driver, to be used with Vimar EvoEikon or equivalent dimmers, included

VERSIONE 400 mA

LED	Dim.	H	Kg	k	lm product/beam 3000K	CODE
19	100x440	37	1,30	2600		APSB3.9 ● /##

Alimentatore non incluso, possibilità di abbinare driver On- off, Dali touch & Dimm, Dali 1-10V. Driver not included, it can be used with On- off, Dali touch & Dimm, Dali 1-10V dimmers.

APP-EAL 1

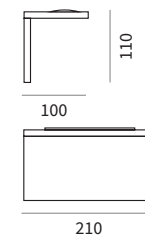

VERSIONE 230V

LED	Dim.	H	Kg	K	lm product/beam 3000K	CODE
12	100x210	110	1,2	3000	940	APE01/##
12	100x210	110	1,2	4000	960	APE02/##

Alimentatore dimmerabile a taglio di fase incluso per dimmer dedicati tipo Vimar EvoEikon od equivalenti. Phase cut driver, to be used with Vimar EvoEikon or equivalent dimmers, included

VERSIONE 400 mA

LED	Dim.	H	Kg	k	lm product/beam 3000K	CODE
10	100x210	110	1,2	1300		APE03.9 ● /##

Alimentatore non incluso, possibilità di abbinare driver On- off, Dali touch & Dimm, Dali 1-10V. Driver not included, it can be used with On- off, Dali touch & Dimm, Dali 1-10V dimmers.

APP-EAL 2

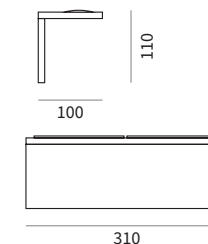

VERSIONE 230V

LED	Dim.	H	Kg	K	lm product/beam 3000K	CODE
23	100x310	110	1,5	3000	1880	APEB1/##
23	100x310	110	1,5	4000	1920	APEB2/##

Alimentatore dimmerabile a taglio di fase incluso per dimmer dedicati tipo Vimar EvoEikon od equivalenti. Phase cut driver, to be used with Vimar EvoEikon or equivalent dimmers, included

VERSIONE 400 mA

LED	Dim.	H	Kg	k	lm product/beam 3000K	CODE
19	100x310	110	1,5	2600		APEB3.9 ● /##

Alimentatore non incluso, possibilità di abbinare driver On- off, Dali touch & Dimm, Dali 1-10V. Driver not included, it can be used with On- off, Dali touch & Dimm, Dali 1-10V dimmers.

INDOOR - Mini Track system & projectors



MICROFILE P.298



LEVA P.300 NEW



LEVA QUADRA P.302

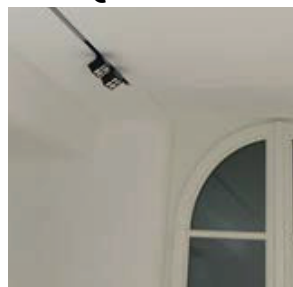

IRIDE P.303



FOCUS P.304



IPIPEDI P.306 NEW



GRID P.315 NEW

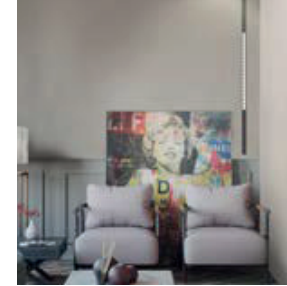

MINIGRID P.316 NEW

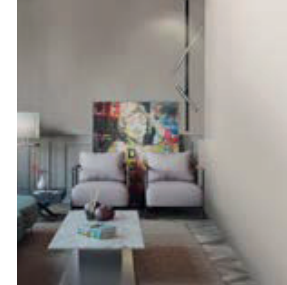

CUBOTTI PAGINA 318 NEW

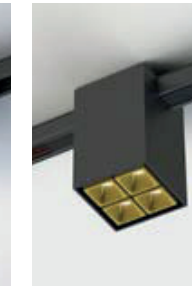
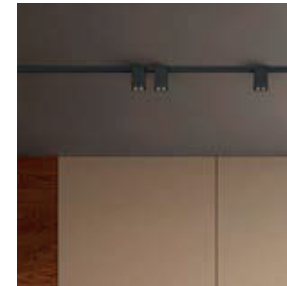

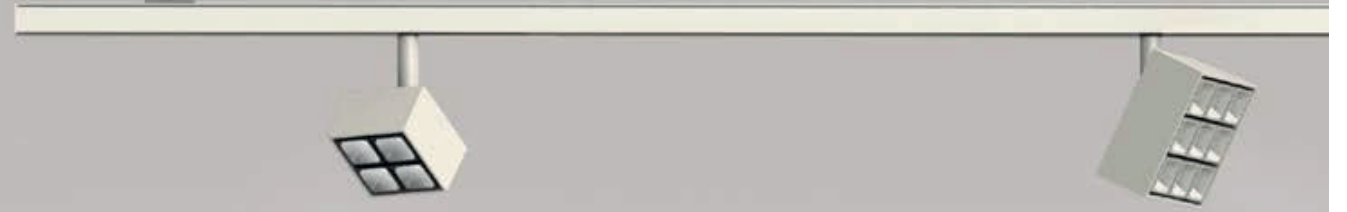

MINI TRACK

& PROJECTORS

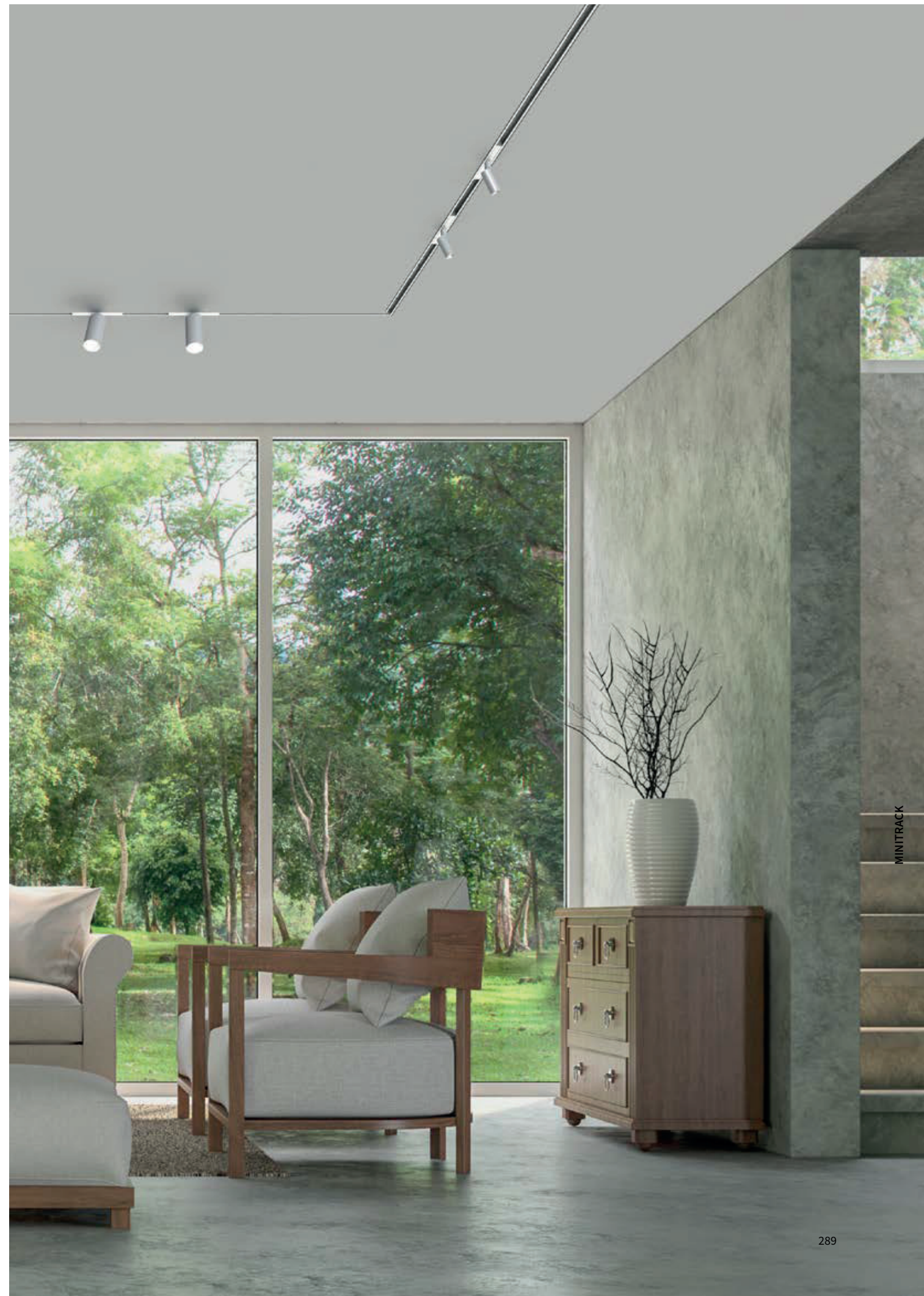
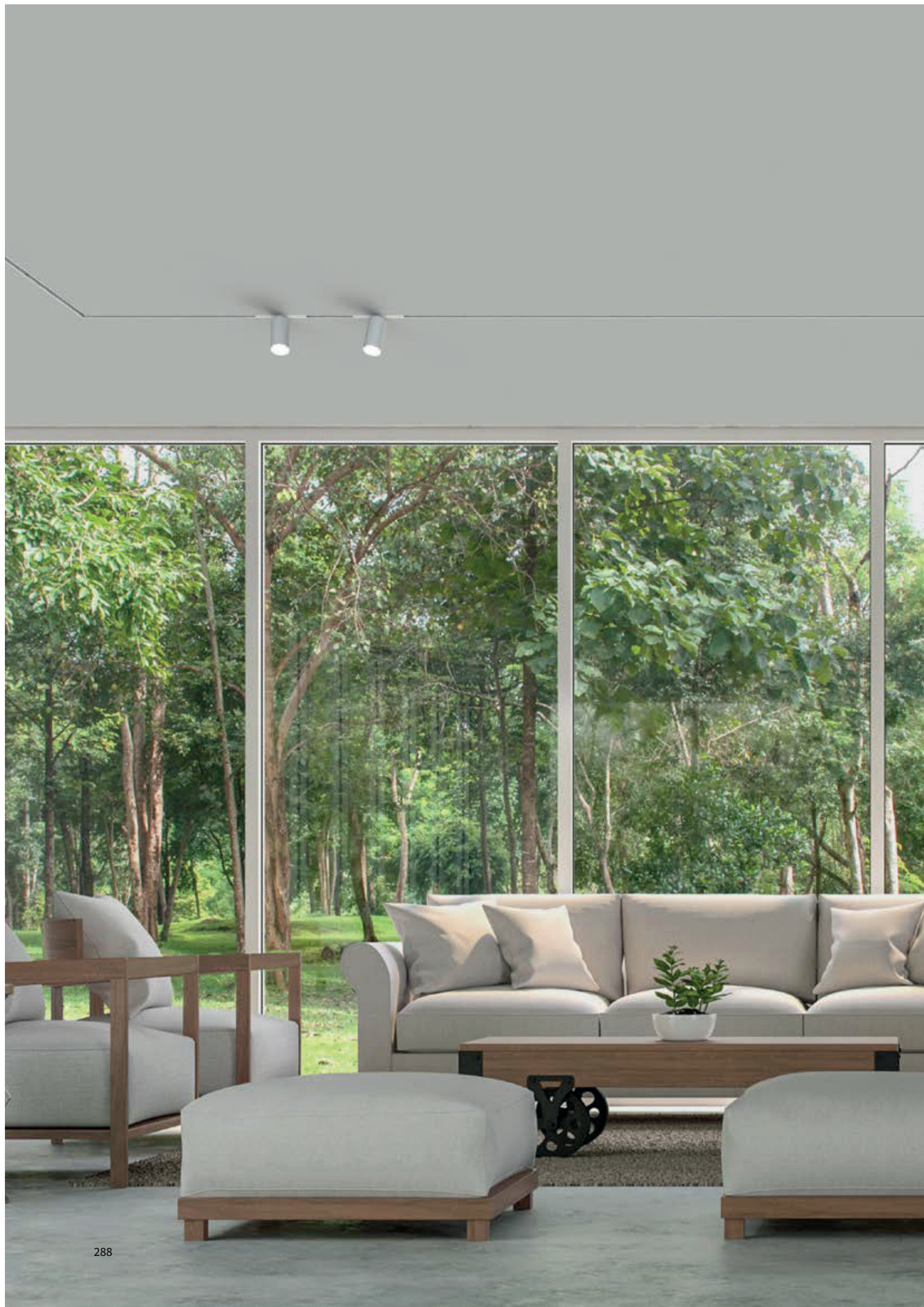

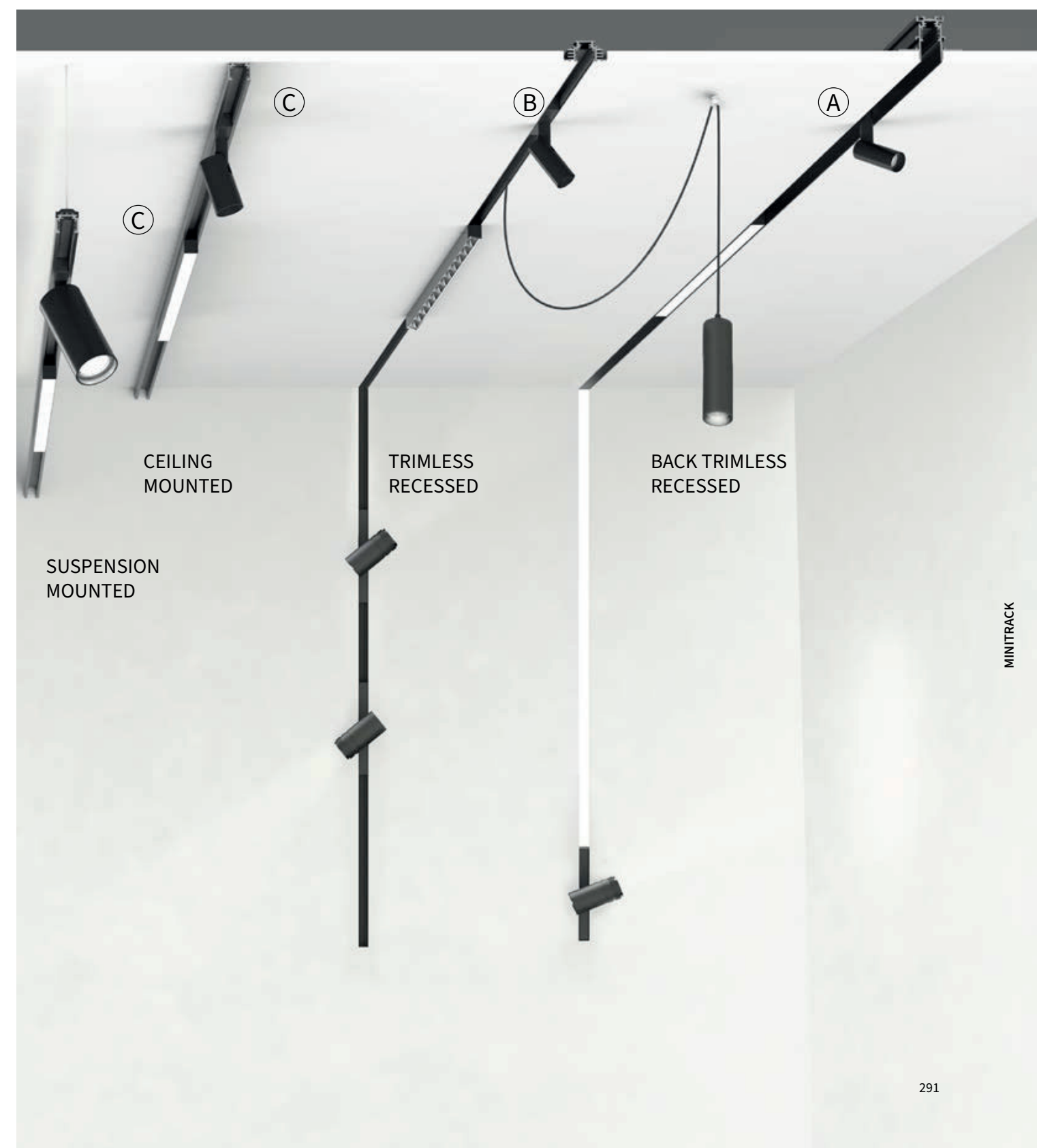
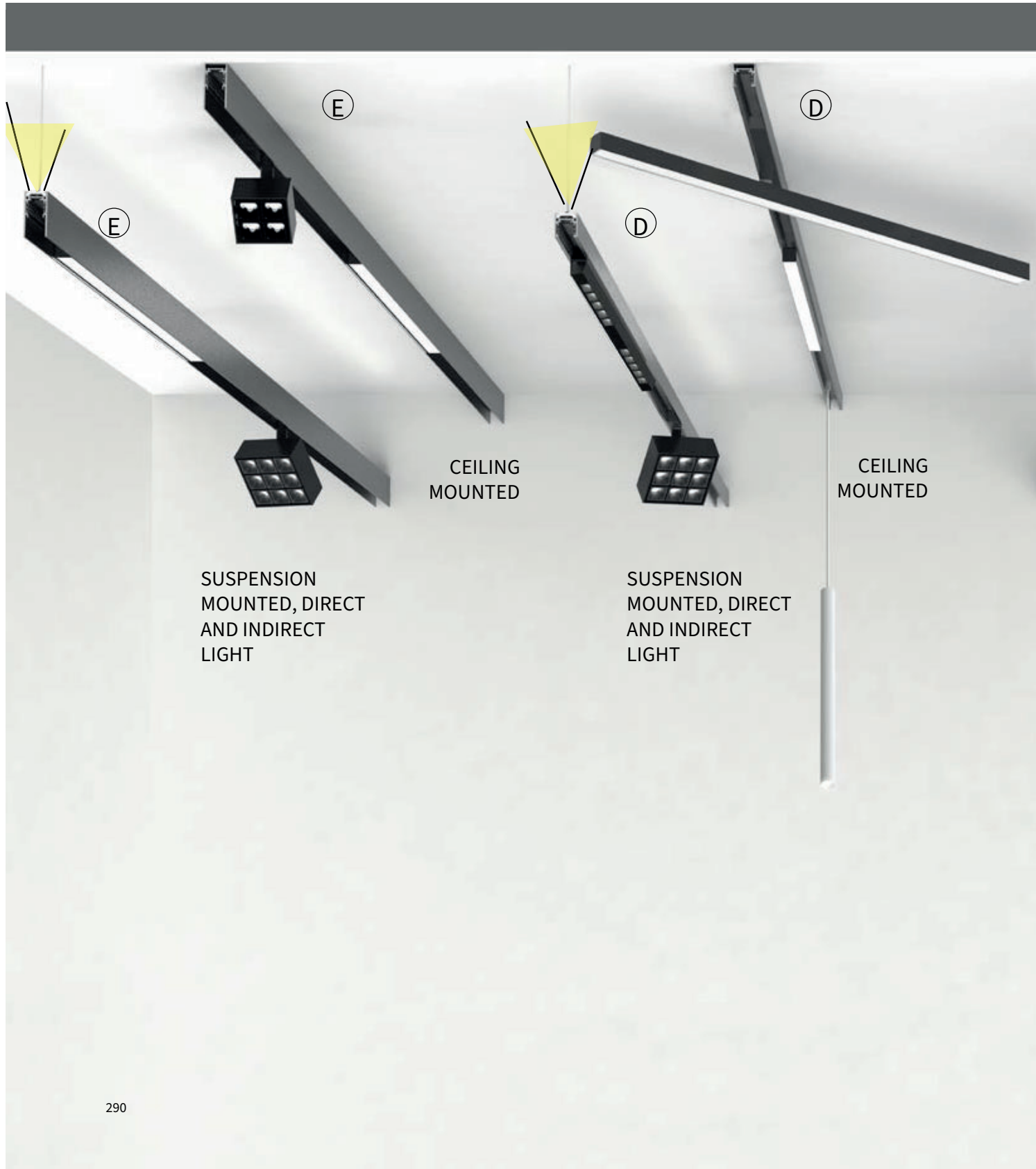
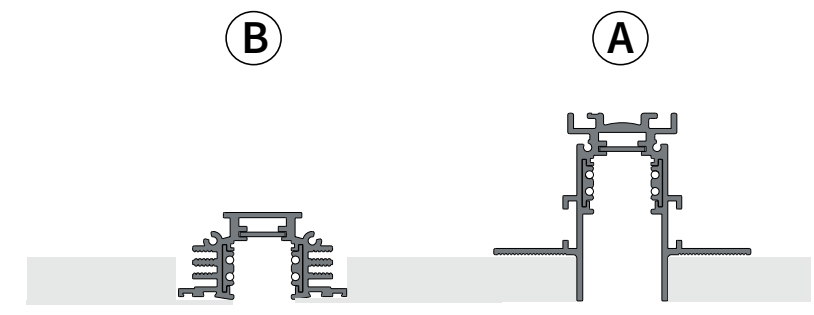
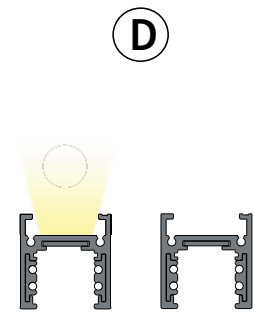
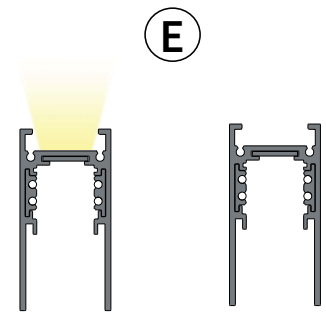

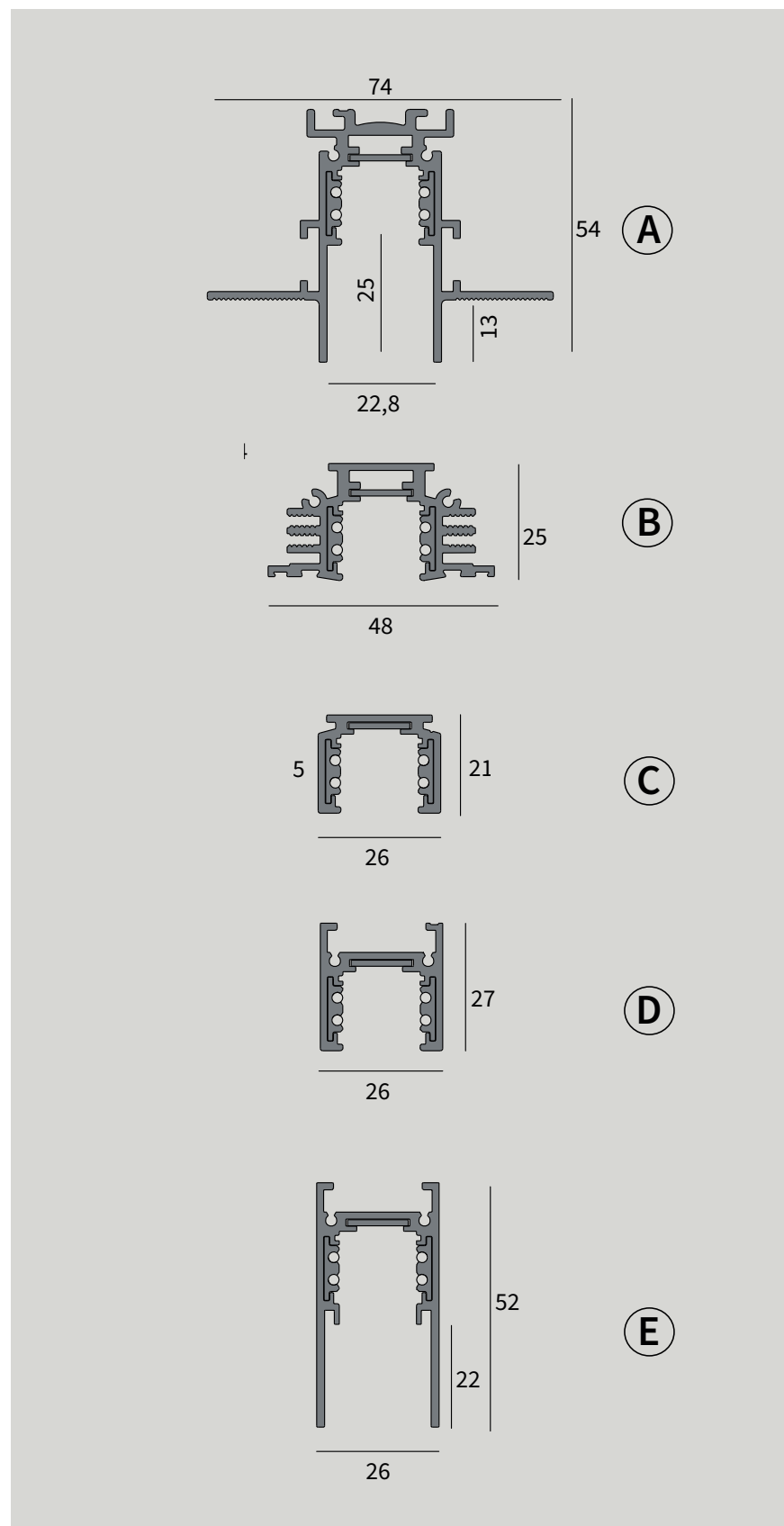

MINITRACK

Il binario Mini Track è un binario elettrificato in Classe III-SELV con due circuiti: uno per una alimentazione a bassa tensione 24/48V e l'altra per il DATA BUS (DALI o 1-10V). La tensione di alimentazione può essere a 24V o 48V a seconda dei modelli di corpi illuminanti prescelti e la corrente di alimentazione non deve essere superiore ai 15A. Nelle versioni a soffitto o a sospensione sono disponibili le finiture bianca e nera mentre nelle versioni da incasso solamente quella nera. I corpi illuminanti proposti possono essere utilizzati su binari elettrificati a 24V o 48V, tranne gli articoli della famiglia microfile che necessitano esclusivamente il 24V. I faretto dimmerabili DALI sono equipaggiati con converter non polarizzati che permettono l'innesco in qualsiasi verso, e tecnologia Hot Plug per l'inserimento in sicurezza con binario in tensione.

The Mini Track track is an electrified Class III-SELV track with two circuits: one for a low voltage 24/48V power supply and the other for the DATA BUS (DALI or 1-10V). The power supply voltage can be 24V or 48V, not exceeding 15A, depending on the models of lighting fixtures chosen. White and black finishes are available in the ceiling and suspended versions, while only the black finishing for the recessed option. The lighting fixtures can be used on both 24V or 48V electrified tracks, except the microfile family that requires only 24V. DALI dimmable spotlights are equipped with non-polarized converters that allow to be installed in any direction, and Hot Plug technology for safe insertion with live track.



UK CONFORMITY ASSESSMENT E EUROPEAN CERTIFICATION / UK CONFORMITY ASSESSMENT AND EUROPEAN CERTIFICATION



PRODOTTI COSTRUITI CON MATERIALE RICICLABILE / PRODUCTS MADE OF RECYCLABLE MATERIAL



GARANZIA DI 5 ANNI / 5-YEAR WARRANTY



SU RICHIESTA GESTIONE BLUETOOTH UPON REQUEST BLUETOOTH MANAGEMENT





VERSIONI DISPONIBILI/AVAILABLE VERSION

FINITURA/FINISHING

 /01 bianco | white

 /02 nero | black

COMPOSIZIONE CODICE: xxx.x /##
 HOW TO CREATE THE CODE: **F1000/01**

CODE
F1000 /## — finishing
 |
 base code

MINI TRACK 24/48V INCASSO RASATO ARRETRATO 24/48V BACK RECESSED TRACK MODULE



Dim. mm	Lmm	CODE
	1000	LT9301/##
74x54	2000	LT9302/##
	3000	LT9303/##

Da completare con gli accessori | To complete with accessories*

MINI TRACK 24/48V INCASSO RASATO 24/48V RECESSED TRACK MODULE



Dim. mm	Lmm	CODE
	1000	LT9201/##
48x25	2000	LT9202/##
	3000	LT9203/##

Da completare con gli accessori | To complete with accessories*

MINI TRACK 24/48V SOFFITTO 24/48V TRACK MODULE



Dim. mm	Lmm	CODE
	1000	LT9101/##
28x21	2000	LT9102/##
	3000	LT9103/##

Da completare con gli accessori | To complete with accessories*

MINI TRACK 24/48V BIEMISSIONE 24/48V BIEMISSION TRACK MODULE



Dim. mm	Lmm	CODE
	1000	LT9401/##
26x27	2000	LT9402/##
	3000	LT9403/##

Da completare con gli accessori | To complete with accessories*

MINI TRACK 24/48V BIEMISSIONE ARRETRATA 24/48V BACK BIEMISSION TRACK MODULE



Dim. mm	Lmm	CODE
	1000	LT9501/##
26x52	2000	LT9502/##
	3000	LT9503/##

Da completare con gli accessori | To complete with accessories*

*È vietato utilizzare alimentatori, driver, sistemi Bus Dati e componenti non omologati SELV e/o che abbiano una U-OUT maggiore di 60 V dc - Lucifero's raccomanda l'utilizzo di un ripetitore optoisolato DALI compatibile. The use of NON SELV or U-OUT > 60V dc power supplies, drivers and components is strictly forbidden. - Lucifero's recommends the usage of an opto-insulated repeater DALI compatible.

TAPPO DI CHIUSURA PER PROFILO LT91## SOFFITTO/SOSPENSIONE BLIND END FOR CODE LT91## WALL/CEILING MOUNTING



profilo/profile	CODE
(C)	LT9110/##

1 pz
 Ordinare almeno 2 pezzi | To order minimum 2 pcs

TAPPO DI CHIUSURA PER PROFILO LT92## INCASSO RASATO RECESSED TRACKS BLIND END FOR CODE LT92## TRIMLESS RECESSED MOUNTING



profilo/profile	CODE
(B)	LT9210/02

1 pz
 Ordinare almeno 2 pezzi | To order minimum 2 pcs

TAPPO DI CHIUSURA PER PROFILO LT93## E LT95## ARRETRATO BACK RECESSED TRACK BLIND END



profilo/profile	CODE
(A) (E)	LT9310/02

1 pz
 Ordinare almeno 2 pezzi | To order minimum 2 pcs

TAPPO DI CHIUSURA PER PROFILO LT94## BIEMISSIONE BIEMISSION TRACK BLIND END



profilo/profile	CODE
(D)	LT9410/##

1 pz
 Ordinare almeno 2 pezzi | To order minimum 2 pcs

TESTATA NON POLARIZZATA NON-POLARIZED HEAD

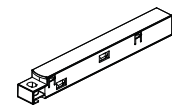

24V 48V CE
CODE
LT9120/##

GIUNTO LINEARE NON POLARIZZATO NOT POLARIZED CONNECTOR FOR TRACK SYSTEM

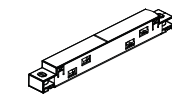

24V 48V CE
CODE
LT9123/##

GIUNTO ANGOLARE NON POLARIZZATO NOT POLARIZED ANGLE CONNECTOR FOR TRACK SYSTEM



24V 48V CE
CODE
LT9126/##
Richiede taglio profilo a 45° | Necessary cut 45° in the profile

COPIA DI STAFFE DI FISSAGGIO BINARIO INCASSO RASATO COUPLE OF FLUSH MOUNTING BRACKET FOR RECESSED TRACK

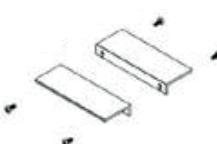

profilo/profile
A B
CODE
LT9211
**Una ogni (vedi immagini sotto con indicazione del carico) | One every (see the image below with the indication of load)

GIUNTO MECCANICO DI UNIONE BINARIO INCASSO E INCASSO ARRETRATO REINFORCEMENT BRACKET FOR DIRECT RECESSED AND RECESSED FLUSH MOUNTING

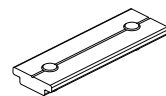

profilo/profile
A B
CODE
LT9212/02

GIUNTO 90 SOLO PER LT94** E LT95** 90° JOINT ONLY FOR LT94** AND LT95**



profilo/profile
D E
CODE
LT9346/02
Richiede taglio profilo a 45° | Necessary cut 45° in the profile

ALIMENTATORE PER BINARIO POWER SUPPLY FOR MINI TRACK

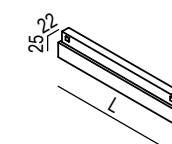

	W	Lmm	CODE
48VDC	100	247	LT92.100
48VDC	200	317	LT92.200

GIUNTO MECCANICO DI UNIONE PER BINARIO SOSPENSIONE REINFORCEMENT BRACKET FOR SUSPENSION

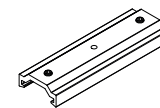

profilo/profile
A
CODE
LT9112

STAFFA DI FISSAGGIO BIEMISSIONE FLUSH MOUNTING BRACKET FOR BIEMISSION TRACK

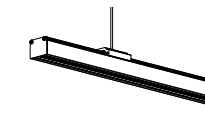
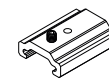

profilo/profile
D E
CODE
LT9411
**Per la quantità da ordinare vedi immagine sotto con indicazione del carico | For the quantity see the image below with the indication of load

STAFFA PER SOSPENSIONE SUSPENSION HANGER

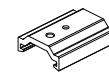

profilo/profile
C D E
CODE
LT9111/##
**Per la quantità da ordinare vedi immagine sotto con indicazione del carico | For the quantity see the image below with the indication of load

SOSPENSIONE CON CAVO DI ACCIAIO STEEL SUSPENSION CABLE- JUNTA DE SUSPENSION CON ALIMENTADOR

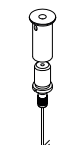

profilo/profile	Lmm	CODE
C D E	2000	LT9036.1
C D E	4000	LT9036.1.4

**Per la quantità da ordinare vedi immagine sotto con indicazione del carico | For the quantity see the image below with the indication of load

DIFFUSORE INDIRETTO IN POLICARBONATO OPALINO / INDIRECT OPAL WHITE POLYCARBONATE DIFFUSER



Lmm	Kg	CODE
1000	0.16	LT94P.1000
2000	0.33	LT94P.2000
3000	0.50	LT94P.3000

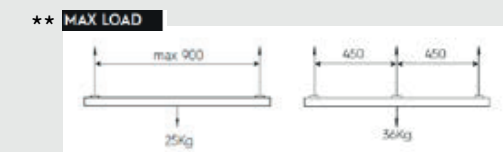

DRIVER DA ABBINARE REMOTO REMOTE POWER SUPPLY

CODE	On/Off	Dali	Push & Dimm	1-10V	I	Vin	Vout range	W	LXPxH (mm)	Ø (mm)	IP
48V AE100.48V	●				0	90-264V	48V	100	200,5x69,5x39	80	20
AE50.48V	●				0	220-240V	48	50	225x60x36	70	20

VERSIONI DISPONIBILI/AVAILABLE VERSION

FINITURA/FINISHING

- /01 bianco | white
- /02 nero | black

COMPOSIZIONE CODICE: xxx.x /##
HOW TO CREATE THE CODE: F1000/01

CODE
F1000 /## — finishing
|
base code

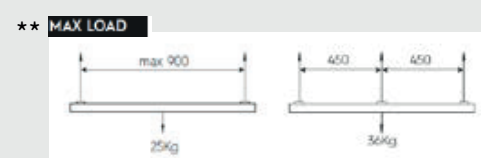



MICROFILE

MINI TRACK

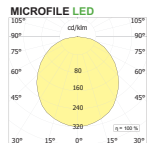
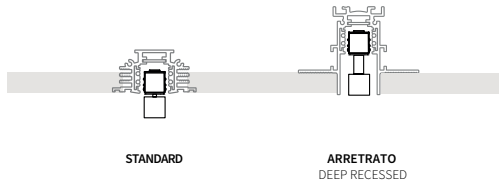

VERSIONI DISPONIBILI/AVAILABLE VERSION

- KELVIN**
- 27 2700K
- 30 3000K
- 35 3500K
- 40 4000K
- TW Tunable White Dali
- KELVIN**
- 27 2700K
- 30 3000K
- 35 3500K
- 40 4000K
- DIMMABLE (OPTIONAL)**
- D Dali

- FINITURA/FINISHING**
- /01 bianco | white
- /02 nero | black

Per la versione Dali scegliere un alimentatore ON OFF da posizionare remoto. For Dali version combine a ON OFF power supply to place remotely

Su richiesta gestione Bluetooth Upon request Bluetooth management

COMPOSIZIONE CODICE: xxx.X ●●/##
 HOW TO CREATE THE CODE: **F1000.8270/01**
 CODE
F1000.8 | ● | ● | ## | — finishing
 base code kelvin dimmable

MICROFILE MINI TRACK / MICROFILE MINI TRACK

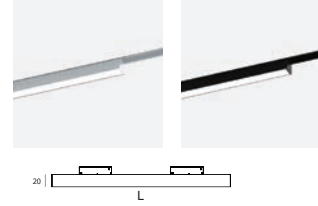

W	Lmm	lm prod 3000K	CODE
19,8	925	980	MF101.8 ●●/##
26,4	1220	1290	MF102.8 ●●/##
33	1515	1600	MF103.8 ●●/##

W	Lmm	lm prod 3000K	CODE
19,8	950	1280	MF111.8 ●●●/##
26,4	1262	1700	MF112.8 ●●●/##
33	1515	2040	MF113.8 ●●●/##

Binario (LT91, LT92, LT94) da ordinare separatamente | Track system (LT91, LT92, LT94) to be ordered separately.
 TYPE **A C D**

MICROFILE TRACK ARRETRATO MICROFILE DEEP RECESSED TRACK

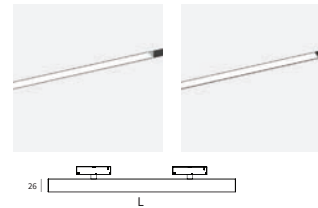

W	Lmm	lm prod 3000K	CODE
19,8	925	980	MF201.8 ●●/##
26,4	1220	1290	MF202.8 ●●/##
33	1515	1600	MF203.8 ●●/##

W	Lmm	lm prod 3000K	CODE
19,8	950	1280	MF211.8 ●●●/##
26,4	1262	1700	MF212.8 ●●●/##
33	1515	2040	MF213.8 ●●●/##

Binario (LT93, LT95) da ordinare separatamente | Track system (LT93, LT95) to be ordered separately.
 TYPE **B E**

MICROFILE MINI TRACK SHANGHAI

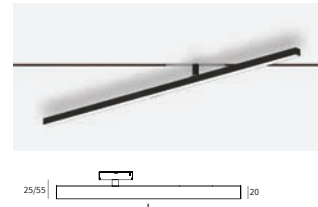

lineardi luce-LED line

W	Lmm	H	lm product 3000K	CODE
19,8	925	55+ADAPTER	980	MF303.8 ●●/##
26,4	1220	55+ADAPTER	1290	MF304.8 ●●/##

lineardi luce-LED line

W	Lmm	H	lm product 3000K	CODE
19,8	925	55+ADAPTER	1280	MF313.8 ●●●/##
26,4	1220	55+ADAPTER	1700	MF314.8 ●●●/##

Binario (LT91, LT92, LT94) da ordinare separatamente | Track system (LT91, LT92, LT94) to be ordered separately.
 MF303.8 e MF304.8 idonei anche per incasso arretrato - Suitable for deep recessed version also.
 TYPE **A C D**



LEVA

MINI TRACK

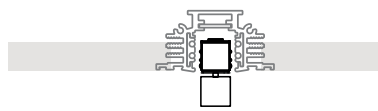
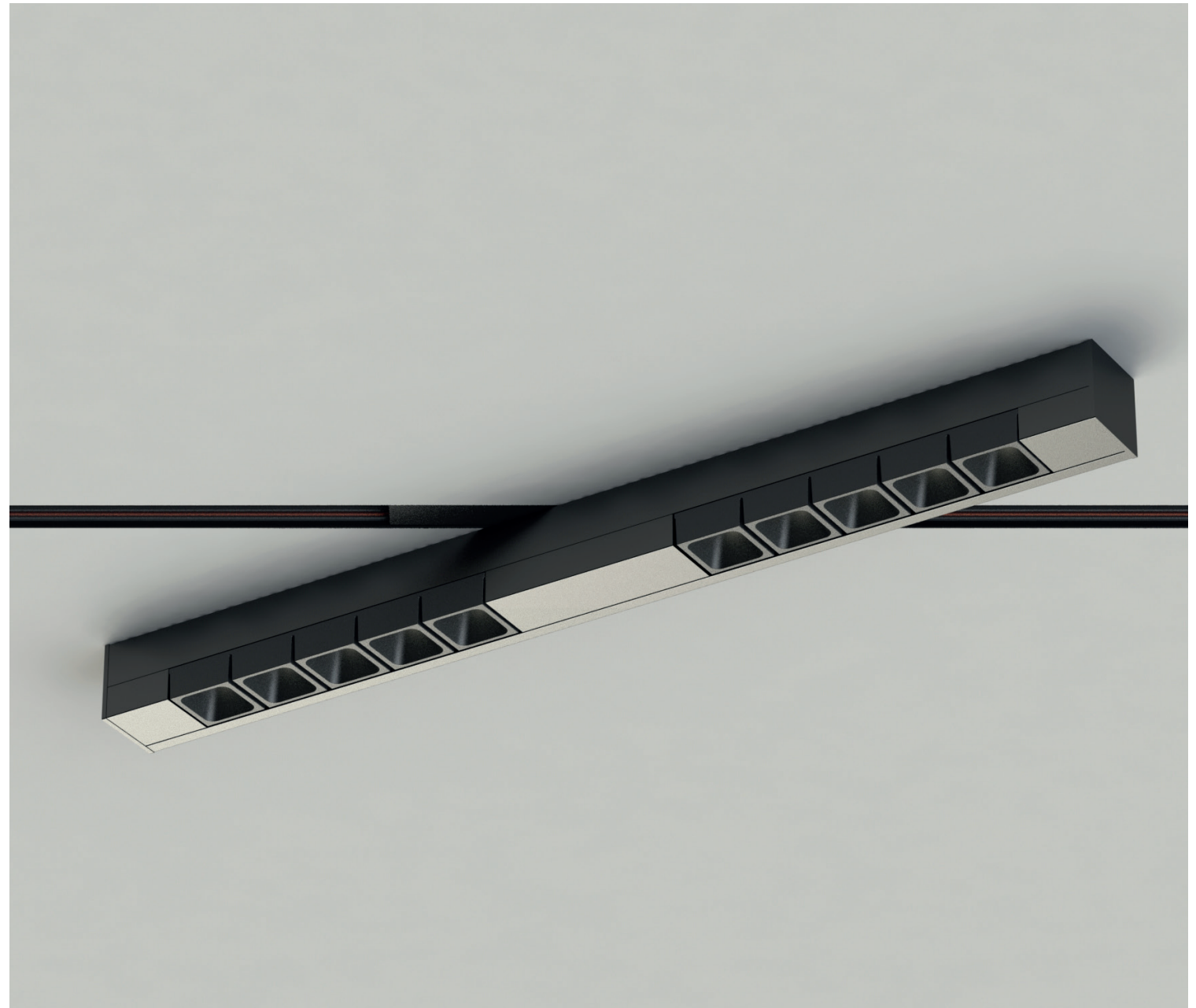

STANDARD

VERSIONI DISPONIBILI/AVAILABLE VERSION

- **KELVIN**
- 27 2700K
- 30 3000K
- 35 3500K
- 40 4000K
- TW Tunable White Dali

- **FASCIO/BEAM**
- Spot
- Flood
- Wide
- Asymmetric

- **DIMMABLE (OPTIONAL)**
- D Dali Touch & Dimm

Per la versione Dali scegliere un alimentatore ON OFF da posizionare remoto.
For Dali version combine a ON OFF power supply to place remotely

- ## **FINITURA/FINISHING**
- /01 telaio bianco, ottica nera | white frame, black optic
- /02 telaio nero, ottica nera | black frame, black optic
- /41 telaio bianco, ottica bianca | white frame, white optic
- /42 telaio nero, ottica oro | black frame, gold optic

DRIVERS VEDI | SEE "ALIMENTATORI" A PAGINA 452

LEVA 10 MINI TRACK

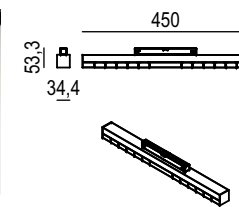

LED	Dim.	H	Kg	Im product/beam 3000K	CODE
22	32x310	62	0.66	20° 32° 50° 41°x18°	2004 1862 1656 1754 LV220.9 ●●/##

Binario (LT91, LT92, LT94) da ordinare separatamente | Track system (LT91, LT92, LT94) to be ordered separately.
TYPE A C D



LEVA QUADRA MINI TRACK

- **KELVIN**
- 27 2700K
- 30 3000K
- 35 3500K
- 40 4000K
- TW Tunable White

- **FASCIO/BEAM**
- S Spot
- F Flood
- W Wide

● **DIMMABLE (OPTIONAL)**

- D Dali Touch & Dimm
- I

Per la versione Dali scegliere un alimentatore ON OFF da posizionare remoto.
For Dali version combine a ON OFF power supply to place remotely

/## **FINITURA/FINISHING**

- /01 telaio bianco, ottica nera | white frame, black optic
- /02 telaio nero, ottica nera | black frame, black optic
- /41 telaio bianco, ottica bianca | white frame, white optic
- /42 telaio nero, ottica oro | black frame, gold optic

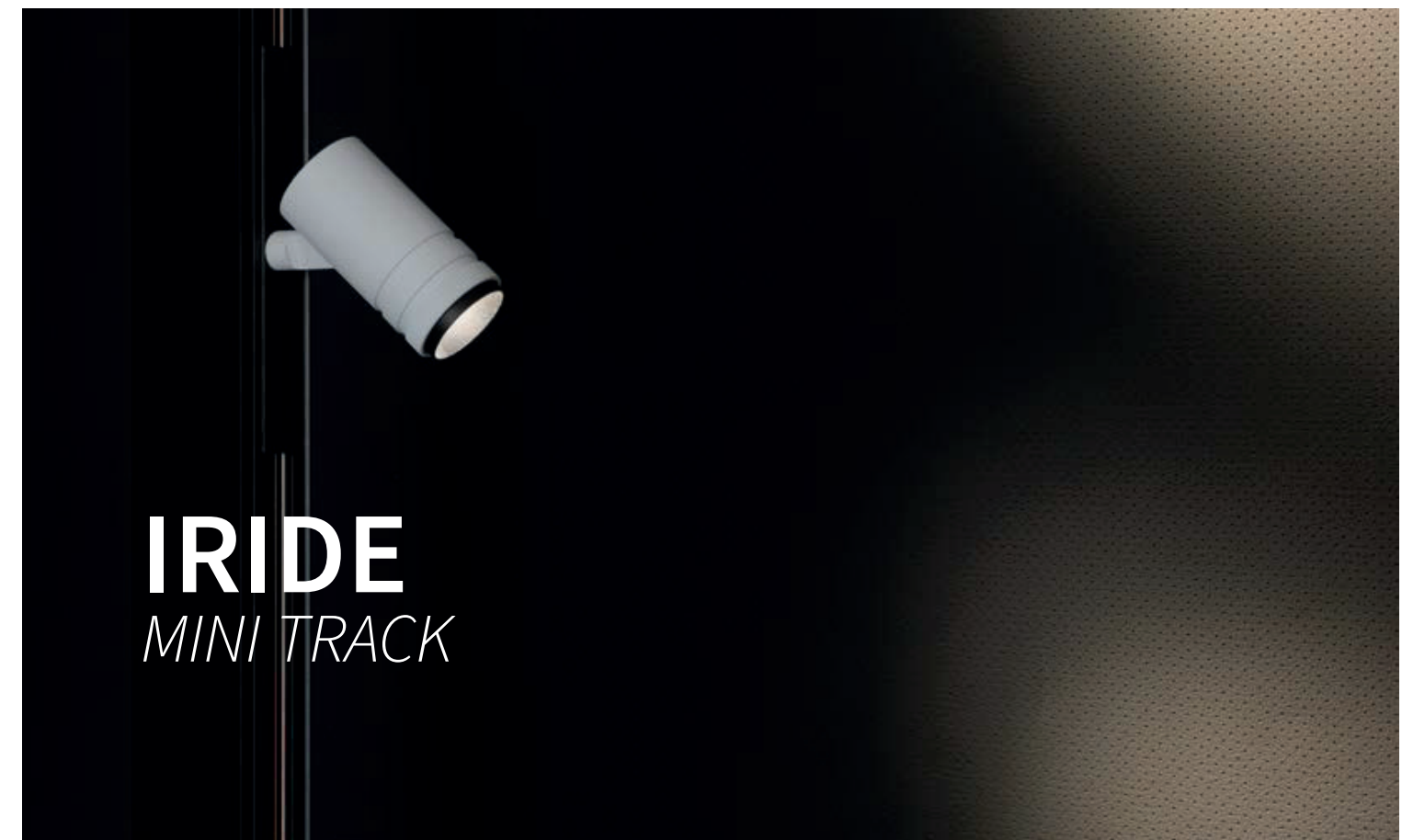

IRIDE MINI TRACK

LEVA QUADRA Q4 MINI TRACK

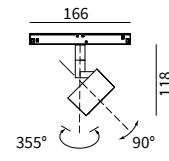
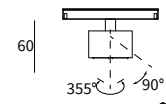

STANDARD

W	Dim.	H	Kg	S20°	F32°	W50°	CODE
8,8	68x68	60+adapter	0,60	800	745	662	LV321.9 ●●●/##

ARRETRATO DEEP RECESSED TRACK

W	Dim.	H	Kg	S20°	F32°	W50°	CODE
8,8	68x68	118+adapter	0,60	800	745	662	LV321A.9 ●●●/##

LEVA QUADRA Q9 MINI TRACK

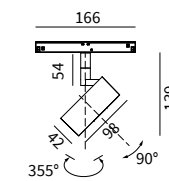
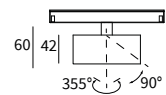

STANDARD

W	Dim.	H	Kg	S20°	F32°	W50°	CODE
19,8	98x98	60+adapter	0,90	1800	1676	1490	LV325.9 ●●●/##

ARRETRATO DEEP RECESSED TRACK

W	Dim.	H	Kg	S20°	F32°	W50°	CODE
19,8	98x98	139+adapter	0,90	1800	1676	1490	LV325A.9 ●●●/##

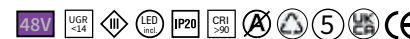
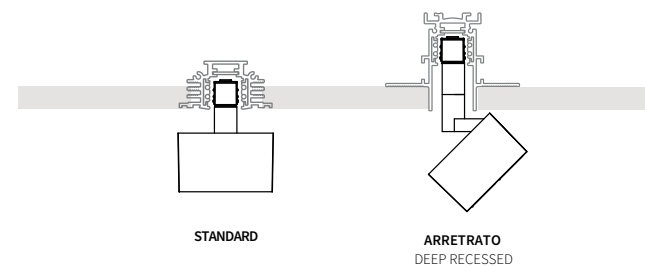

IRIDE MINI TRACK 43L

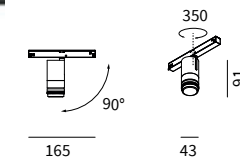

W	Ø	H	Im product/beam 3000K	CODE
6,7	43	742	742	IR08.9 ●●●/##

ACCESSORI / ACCESSORIES



LENTE OPZIONALE / OPTIONAL LENS	Ø	Kg	CODE
FILTRO NIDO D'APE/HONEY COMB LOUVER	43	0,01	L043R



- **KELVIN**
- 27 2700K
- 30 3000K
- 35 3500K
- 40 4000K

- **FASCIO/BEAM**
- W Wide 39°

● **DIMMABLE (OPTIONAL)**

- D Dali Touch & Dimm

Per la versione Dali scegliere un alimentatore ON OFF da posizionare remoto.
For Dali version combine a ON OFF power supply to place remotely

/## **FINITURA/FINISHING**

- /01 bianco | white
- /02 nero | black
- /21 bianco, anello cromo | white, chrome ring
- /25 nero, anello cromo | black, chrome ring
- /28 bianco, anello nero | white, black ring

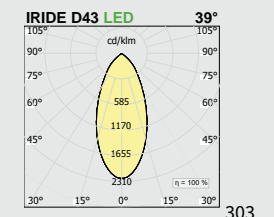



FOCUS MINI TRACK

VERSIONI DISPONIBILI/ AVAILABLE VERSION

● KELVIN

- 27 2700K
- 30 3000K
- 35 3500K
- 40 4000K

● FASCIO/BEAM

- S Spot
- F Flood
- Z Asymmetric

○ FASCIO/BEAM

- F Flood
- W Wide

Per i gradi vedi in tabella. For degree check the table.

● DIMMABLE (OPTIONAL)

- D Dali Touch & Dimm

Per la versione Dali scegliere un alimentatore ON OFF da posizionare remoto.
For Dali version combine a ON OFF power supply to place remotely

/ ## FINITURA/FINISHING

- /01 bianco | white
- /02 nero | black
- /03 cromo | chrome

48V DRIVERS VEDI | SEE "ALIMENTATORI" A PAGINA 45

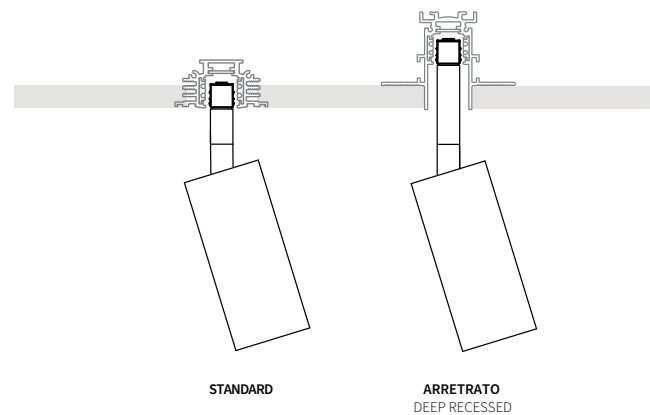

ACCESSORI / ACCESSORIES

LENTI / LENSES		Kg	Ø	CODE	Ø	CODE	Ø	CODE	Col.
	LENTE SATINATA / SATINED LENS	0,01	26	L026S.A/	36	L036S.A/	55	L055S.A/	01-02
	LENTE ELISSOIDALE / ELIPSOID LENS	0,01	26	L026E.A/	36	L036E.A/	55	L055E.A/	01-02
	LENTE ASIMMETRICA / ASYMMETRIC LENS	0,01	26	L026A.A/	36	L036A.A/	55	L055A.A/	01-02
	FILTRO NIDO DAPE / HONEY COMB LOUVER	0,01	26	L026R.A/	36	L036R.A/	55	L055R.A/	01-02

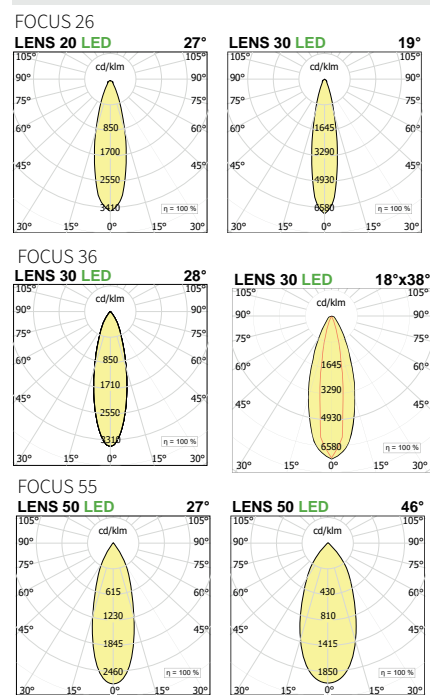

FOCUS T26 MINI TRACK 24/48V



FOCUS T36 MINI TRACK 24/48V



FOCUS T55 MINI TRACK 24/48V



FOCUS 2T26 MINI TRACK 48V



FOCUS 2T36 MINI TRACK 48V



STANDARD

LED 48V	W	Ømm	Hmm	Lmm	F27°	Im product/beam 3000K	CODE
	5,7	26	85	166	571		FS501.9 ● F ● /##

● Disponibile solo fascio F | Available only F beam

ARRETRATO DEEP RECESSED TRACK

LED 48V	W	Ømm	Hmm	Lmm	F27°	Im product/beam 3000K	CODE
	5,7	26	110	166	571		FS501A.9 ● F ● /##

● Disponibile solo fascio F | Available only F beam

STANDARD

LED 48V	W	Ømm	Hmm	Lmm	S19°	F25°	Z18°x38°	CODE
	8	36	92	166	665	695	508	FS502.9 ● ● ● /##

ARRETRATO DEEP RECESSED TRACK

LED 48V	W	Ømm	Hmm	Lmm	S19°	F25°	Z18°x38°	CODE
	8	36	117	166	665	695	508	FS502A.9 ● ● ● /##

STANDARD

LED 48V	W	Ømm	Hmm	Lmm	F27°	W46°	Im product/beam 3000K	CODE
	12,7	55	138	166	1285	1289		FS504.9 ● ● ● /##
	18,5	55	138	166	1575	1579		FS503.9 ● ● ● /##

● Disponibili solo fascio F, W | Available only F, W beam

ARRETRATO DEEP RECESSED TRACK

LED 48V	W	Ømm	Hmm	Lmm	F27°	W46°	Im product/beam 3000K	CODE
	12,7	55	162	166	1285	1289		FS504A.9 ● ● ● /##
	18,5	55	162	166	1575	1579		FS503A.9 ● ● ● /##

● Disponibili solo fascio F, W | Available only F, W beam

Accessori - accessories: L055#.A: Anello Ø55 + lente - lens with ring Ø55



STANDARD

LED 48V	W	Ømm	Hmm	Lmm	F27°	Im product/beam 3000K	CODE
	2 x 6,2	26	85	166	1142		FS551.9 ● F ● /##

ARRETRATO DEEP RECESSED TRACK

LED 48V	W	Ømm	Hmm	Lmm	F27°	Im product/beam 3000K	CODE
	2 x 6,2	26	110	166	1142		FS551A.9 ● F ● /##

STANDARD

LED 48V	W	Ømm	Hmm	Lmm	S19°	F25°	Z18°x38°	Im product/beam 3000K	CODE
	2 x 8,7	36	92	166	1330	1390	1016		FS552.9 ● ● ● /##

ARRETRATO DEEP RECESSED TRACK

LED 48V	W	Ømm	Hmm	Lmm	S19°	F25°	Z18°x38°	Im product/beam 3000K	CODE
	2 x 8,7	36	117	166	1330	1390	1016		FS552A.9 ● ● ● /##



IPIPEDI MINI TRACK

ACCESSORI / ACCESSORIES

LENTI / LENSES Ø 55



	Ø	Kg	CODE	Col.
LENTE SATINATA / SATINED LENS	55	0,01	L055S.A/	01-02
LENTE ELLISSOIALE / ELIPSOID LENS	55	0,01	L055E.A/	01-02
LENTE ASIMMETRICA / ASYMMETRIC LENS	55	0,01	L055A.A/	01-02
FILTRO NIDO D'APE / HONEY COMB LOUVER	55	0,01	L055R.A/	01-02

VERSIONI DISPONIBILI / AVAILABLE VERSION

- KELVIN**
- 27 2700K
- 30 3000K
- 35 3500K
- 40 4000K

- FASCIO / BEAM**
- S** Spot
- F** Flood
- W** Wide

Per i gradi vedi in tabella.
For degree check the table.

48V DRIVERS VEDI | SEE P. 452

- DIMMABLE (OPTIONAL)**
- D** Dali Touch & Dimm

Per la versione Dali scegliere un alimentatore ON OFF da posizionare remoto.
For Dali version combine a ON OFF power supply to place remotely

- ## FINITURA / FINISHING**

- /01** bianco | white
- /02** nero | black
- /60** corten / corten

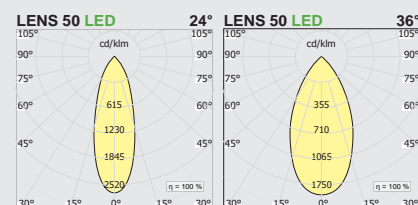

IPIPEDI 30/700H

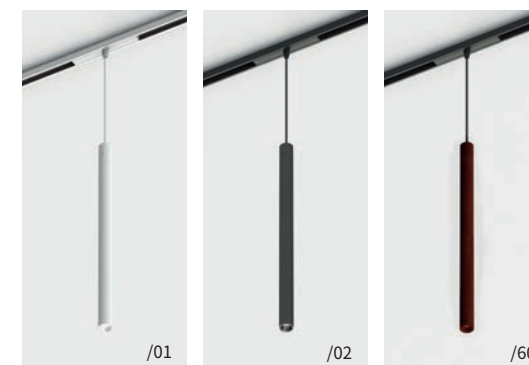
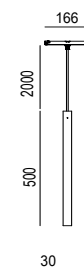

LED			lm product/beam 3000K		
W	Ø	H	S16°	F30°	CODE
8	30	700	695	720	PP002.9 ●●●/##

● Disponibili solo fascio **S, F** | Available only **S, F** beam

IPIPEDI 55/125H

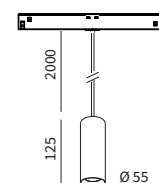

LED 48V			lm product/beam 3000K			
W	Ø	H	Kg	F24°	W36°	CODE
8	55	125 + 2000	1,30	860	860	PP005.9 ●●●/##
12	55	125 + 2000	1,30	1285	1285	PP119.9 ●●●/##
18	55	125 + 2000	1,30	1575	1575	PP120.9 ●●●/##

● Disponibili solo fascio **F, W** | Available only **F, W** beam

IPIPEDI 55/300H

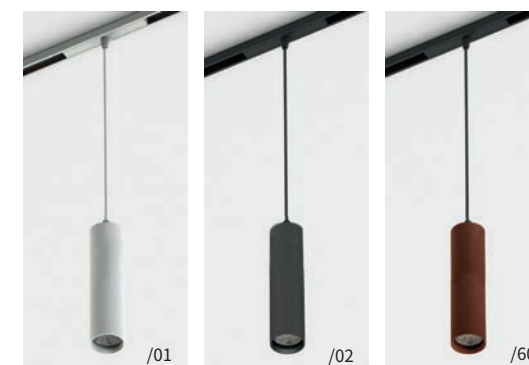
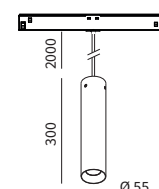

LED 48V			lm product/beam 3000K			
W	Ø	H	Kg	F24°	W36°	CODE
8	55	300	1,26	860	860	PP006.9 ●●●/##
12	55	300	1,26	1285	1289	PP116.9 ●●●/##
18	55	300	1,26	1575	1579	PP117.9 ●●●/##

● Disponibili solo fascio **F, W** | Available only **F, W** beam

iPipedi

Mini Track | Mini Track



Ø55 125h

versione con elemento per decentramento
version with ceiling fixing element

VARIANTE PER DECENTRAMENTO COMPLETO DI CAVO DI LUNGHEZZA DI 4000 mm PIÙ ELEMENTO DI FISSAGGIO A SOFFITTO
DECENTRALIZATION VERSION COMPLETE WITH CABLE LENGTH OF 4000 MM PLUS CEILING FIXING ELEMENT

IPIPEDI 55/125H
MINI TRACK 48V

LED 48V		Im product/beam 3000K		CODE		
W	Ø	H	Kg	F24°	W36°	
8	55	125 + 4000	1,30	860	860	PP005L.9 ●●●/##
		F27°	W46°			
12	55	125 + 4000	1,30	1285	1285	PP116L.9 ●●●/##
18	55	125 + 4000	1,30	1575	1575	PP117L.9 ●●●/##



Ø55 300h

IPIPEDI 55/300H
MINI TRACK 48V

LED 48V		Im product/beam 3000K		CODE		
W	Ø	H	Kg	F24°	W36°	
8	55	300 + 4000	1,30	860	860	PP006L.9 ●●●/##
		F27°	W46°			
12	55	300 + 4000	1,30	1285	1285	PP119L.9 ●●●/##
18	55	300 + 4000	1,30	1575	1575	PP120L.9 ●●●/##

Variante per decentramento completo di cavo di lunghezza di 4000 mm più elemento di fissaggio a soffitto
decentralization version complete with cable length of 4000 mm plus ceiling fixing element



ACCESSORI / ACCESSORIES



LENTI / LENSES Ø 55	Ø	Kg	CODE
LENTE SATINATA / SATINED LENS	55	0,01	L055S.A/ ##
LENTE ELLISSOIDALE / ELIPSOID LENS	55	0,01	L055E.A/ ##
LENTE ASIMMETRICA / ASYMMETRIC LENS	55	0,01	L055A.A/ ##
FILTRO NIDO D'APIE / HONEY COMB LOUVER	55	0,01	L055R.A/ ##

VERSIONI DISPONIBILI / AVAILABLE VERSION

- **KELVIN**
- 27 2700K
- 30 3000K
- 35 3500K
- 40 4000K

- **FASCIO/BEAM**
- F** Flood
- W** Wide

- **DIMMABLE (OPTIONAL)**
- D** Dali Touch & Dimm

Per la versione Dali scegliere un alimentatore ON OFF da posizionare remoto (per alimentare il binario).
For Dali version combine a ON OFF power supply to place remotely (for feed the track)

48V DRIVERS VEDI | SEE 452

FINITURE STANDARD / STANDARD FINISHINGS

- / 01 bianco | white
- / 02 nero | black
- / 60 corten | corten

FINITURE PREMIUM / PREMIUM FINISHINGS

- / 81 oro rosa / rose gold
- / 82 bronzo anticato / antique bronze
- / 83 ottone brunito spazzolato / brushed burnished brass

iPipedi

Mini Track | Mini Track
Ø90



IPIPEDI 90/90H
MINI TRACK 48V

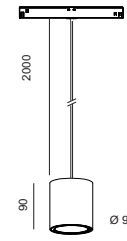

LED				lm product/beam 3000K		CODE
W	Ø	H	Kg	F24°	W38°	
12	90	90	1,0	1289	-	PP040.9 ●●●/##
17	90	90	1,4	1827	1905	PP041.9 ●●●/##
24,3	90	90	1,4	2356	2430	PP042.9 ●●●/##

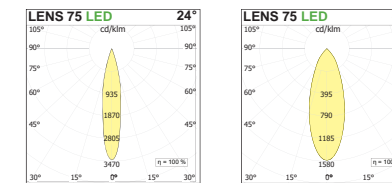

- **KELVIN**
- 27 2700K
- 30 3000K
- 35 3500K
- 40 4000K
- TW Tunable White Dali

- **FASCIO/BEAM**
- F Flood
- W Wide

- **DIMMABLE (OPTIONAL)**
- D Dali Touch & Dimm

Per la versione Dali scegliere un alimentatore ON OFF da posizionare remoto (per alimentare il binario).
For Dali version combine a ON OFF power supply to place remotely (for feed the track)

48V DRIVERS VEDI | SEE "ALIMENTATORI" A PAGINA 452

FINITURE STANDARD /STANDARD FINISHINGS
FINITURE PREMIUM /PREMIUM FINISHINGS

- /01 bianco/white
- /02 nero/black
- /60 corten

- FINITURE PREMIUM /PREMIUM FINISHINGS**
- /81 oro rosa/rose gold
- /82 bronzo antico/antique bronze
- /83 ottone brunito spazzolato/brushed burnished brass

MINITRACK

iPipedi

Mini Track | Mini Track
Ø55



I-PIPEDI 55C MINI TRACK



LED 48V				lm product/beam 3000K		
W	ø	H	Kg	F24°	W36°	CODE
8	55	110	1,30	860	860	PP007.9 ●●● /##
				F27°	W46°	
12	55	110	1,30	1285	1285	PP008.9 ●●● /##
18	55	110	1,30	1575	1575	PP009.9 ●●● /##

MINITRACK

● KELVIN

- 27 2700K
- 30 3000K
- 35 3500K
- 40 4000K
- TW Tunable White Dali

● FASCIO/BEAM

- F Flood
- W Wide

Per i gradi vedere in tabella -
For degree check the table

COMPOSIZIONE CODICE: xxx.x ●● /##

HOW TO CREATE THE CODE: F1000.827S /01

F1000.8 | ● | ● | /## finishing
base code | kelvin | beam

● DIMMABLE (OPTIONAL)

- D Dali Touch & Dimm

Per la versione Dali scegliere un alimentatore ON OFF da posizionare remoto (per alimentare il binario).
For Dali version combine a ON OFF power supply to place remotely (for feed the track)

/## FINITURA/FINISHING (PREMIUM AVAILABLE)

- /01 bianco/white
- /02 nero/black
- /60 corten

48V DRIVERS VEDI | SEE "ALIMENTATORI" A PAGINA 452

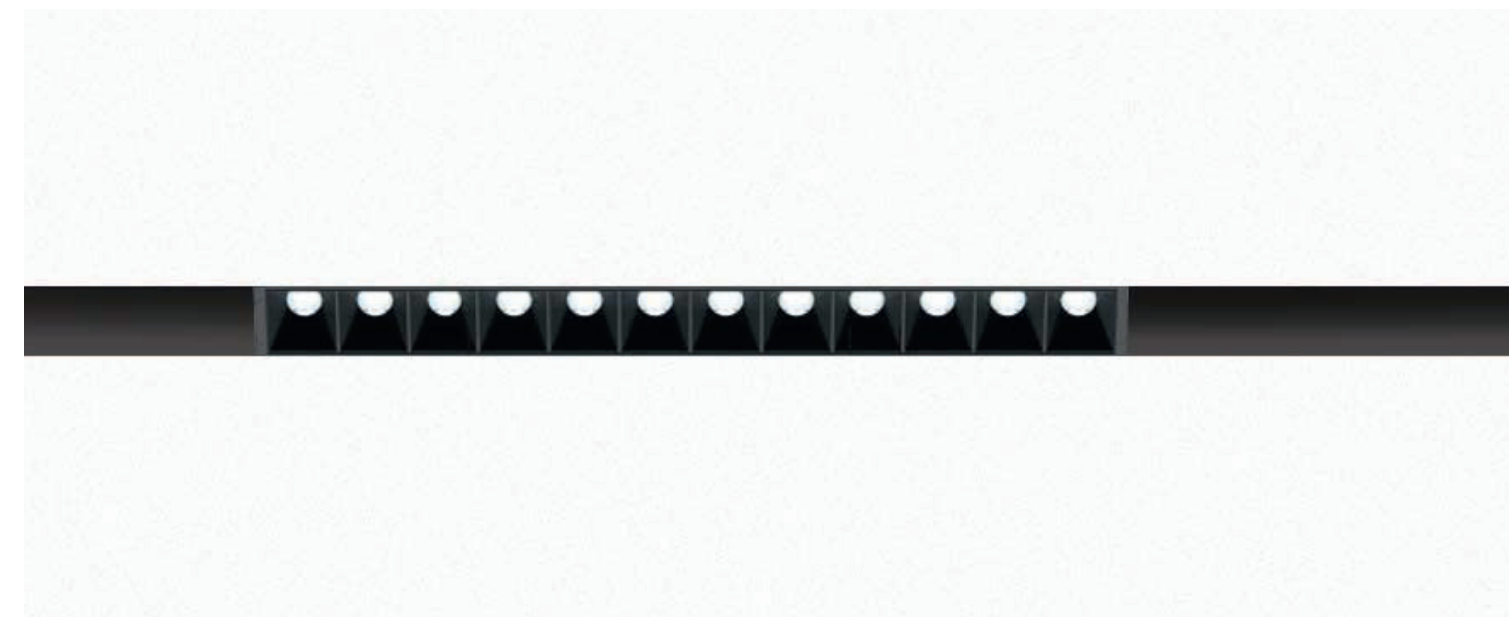

GRID

MINI TRACK

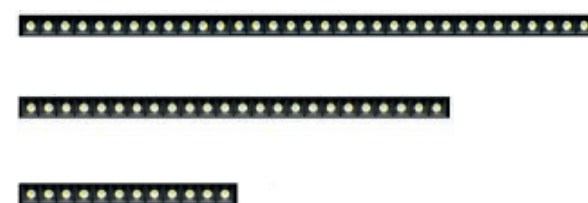

GRID MINI TRACK 48V

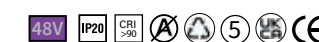

L	W	Lmm	DIM. mm	lm product 3000K		CODE
				24°	36°	
8	8	235	22 X 42 h	560	560	GRD01.9 ●●●/##
16	16	463	22 X 42 h	1100	1100	GRD02.9 ●●●/##
24	24	691	22 x 42 h	1650	1650	GRD03.9 ●●●/##

VERSIONI DISPONIBILI/AVAILABLE VERSION

- **KELVIN**
- 27 2700K
- 30 3000K

- **FASCIO/BEAM**
- F Flood 24°
- W Wide 36°

- **DIMMABLE (OPTIONAL)**
- D Dali Touch & Dimm

Per la versione Dali scegliere un alimentatore ON OFF da posizionare remoto (per alimentare il binario).
For Dali version combine a ON OFF power supply to place remotely (for feed the track)

/## FINITURA/FINISHING

- /01 bianco | white
- /02 nero | black

COMPOSIZIONE CODICE: xxx.x ●●●/##
HOW TO CREATE THE CODE: **F1000.827S/01**

CODE
F1000.8 ● ● ● /## — finishing
base code kelvin beam dimmable

48V DRIVERS VEDI | SEE P.452

MINIGRID

ORIENTABILE | ADJUSTABLE

MINI TRACK



VERSIONI DISPONIBILI/AVAILABLE VERSION

- **KELVIN**
- **FASCIO/BEAM**
- **DIMMABLE (OPTIONAL)**
- /## FINITURA/FINISHING**
- 27 2700K
- F Flood 24°
- D Dali Touch & Dimm
- /01 bianco | white
- /02 nero | black
- W Wide 36°

Per la versione Dali scegliere un alimentatore ON OFF da posizionare remoto (per alimentare il binario).
For Dali version combine a ON OFF power supply to place remotely (for feed the track)

COMPOSIZIONE CODICE: xxx.x ●●●/##
HOW TO CREATE THE CODE: **F1000.827SD/01**

CODE
F1000.8 ● ● ● /## — finishing
base code kelvin beam dimmable

48V DRIVERS VEDI | SEE P.452

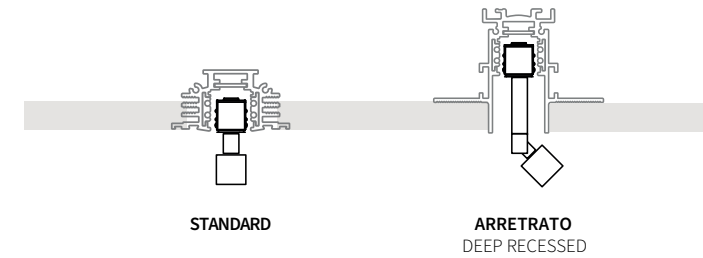

MINIGRID 235 MINI TRACK 48V

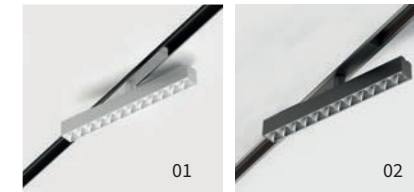

48V IP20 CRI >90

LED 75lm/W

W	Lmm	Hmm	lm product 3000K	CODE
STANDARD			24° 36°	
8	235	22 + adattatore	560	560

GRD11.9 ●●●/##

Binario non incluso / mini track not included

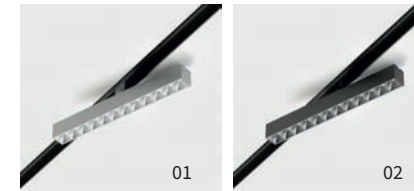

LED 75lm/W

W	Lmm	Hmm	lm product 3000K	CODE
ARRETRATO DEEP RECESSED TRACK				
8	235	47+ adattatore	560	560

GRD11A.9 ●●●/##

Binario non incluso / mini track not included

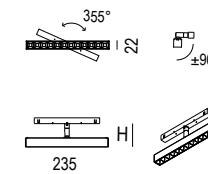

MINIGRID 461 MINI TRACK 48V

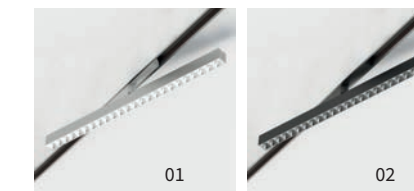

48V IP20 CRI >90

LED 75lm/W

W	Lmm	Hmm	lm product 3000K	CODE
STANDARD			24° 36°	
16	461	22 + adattatore	1100	1100

GRD12.9 ●●●/##

Binario non incluso / mini track not included

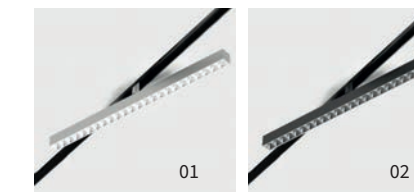

LED 75lm/W

W	Lmm	Hmm	lm product 3000K	CODE
ARRETRATO DEEP RECESSED TRACK				
16	461	47+ adattatore	1100	1100

GRD12A.9 ●●●/##

Binario non incluso / mini track not included

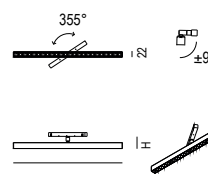

CUBOTTI

MINI TRACK

Collezione di apparecchi per un'illuminazione a binario 24V/48V. Apparecchi a luce diretta, disponibili in due versioni per sorgenti a tensione di rete LED con attacco GU10 o G9. Corpo a sezione quadrata in estruso di alluminio in finitura verniciata. Completati di staffa per fissaggio a soffitto o parete a seconda del modello. Grado di protezione IP20 e classe I.

Ceiling or wall mounted luminaires for direct or direct/indirect lighting, for LED mains voltage sources with GU10 or G9 socket. Square section body in extruded aluminum in painted finish. Complete with bracket for ceiling or wall mounting depending on the model. IP20 and class I.

KELVIN	
27	2700°K
30	3000°K
35	3500°K
40	4000°K
TW	Tunable White

FASCIO / BEAM	
S	SPOT
F	FLOOD
W	WIDE

FINITURE P / P FINISHINGS	
/01	BIANCO / WHITE
/02	NERA / BLACK

FINITURE FC / FC FINISHINGS	
/01	TELAIO BIANCO OTTICA NERA / WHITE FRAME BLACK OPTIC
/02	TELAIO NERO OTTICA NERA / BLACK FRAME BLACK OPTIC
/41	TELAIO BIANCO OTTICA BIANCA / WHITE FRAME WHITE OPTIC
/42	TELAIO NERO OTTICA ORO / BLACK FRAME GOLD OPTIC

FINITURE PREMIUM / PREMIUM FINISHINGS		
81-ORO ROSA / PINK GOLD	82-BRONZO ANTICATO / ANTIQUE BRONZE	83-OTTONE SATINATO / BRUSHED BRASS

CURVE FOTOMETRICHE/PHOTOMETRIC DATA

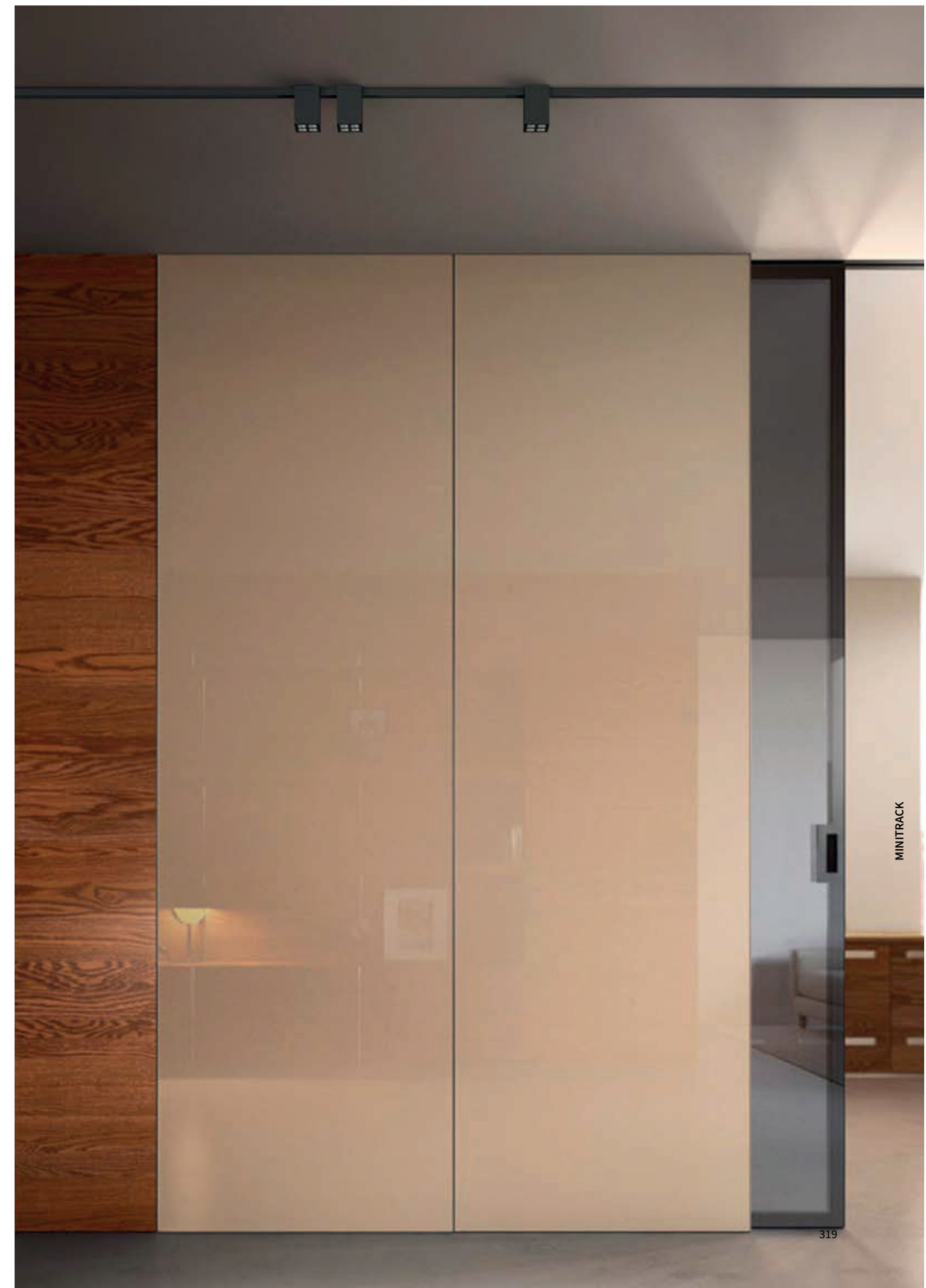
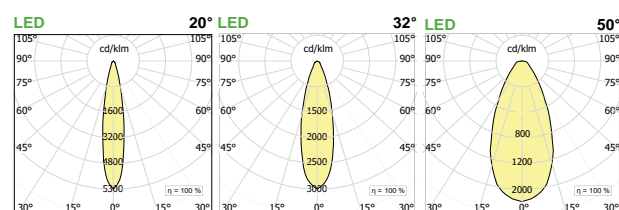

CUBOTTI

CUBOTTI F MINI TRACK INCASSO | RECESSED MINI TRACK

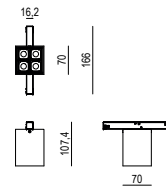
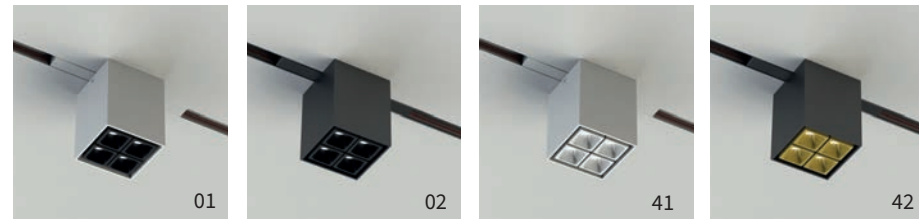

LED 24V e 48V			Im prod./beam 3000K				CODE
W	Dim.	H	Kg	S20°	F32°	W50°	
8,8	70x70	90+adapter	0,80	800	745	662	CB001.9 ●●●/##

Binario non incluso / mini track not included

CUBOTTI PF MINI TRACK INCASSO | RECESSED MINI TRACK

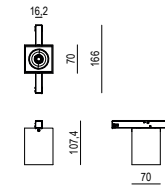
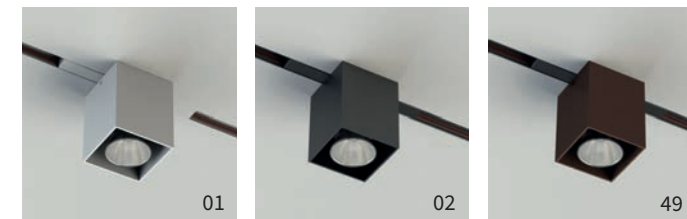

LED			Im prod./beam 3000K				CODE
W	mm	Hmm	Kg	F27°	W46°		
8	70x70	110	0,28	860	860		CB101.9 ●●●/##
12	70x70	110	0,28	1285	1285		CB103.9 ●●●/##

Binario non incluso / mini track not included

CUBOTTI C MINI TRACK SOFFITTO | CEILING MINI TRACK

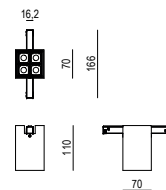
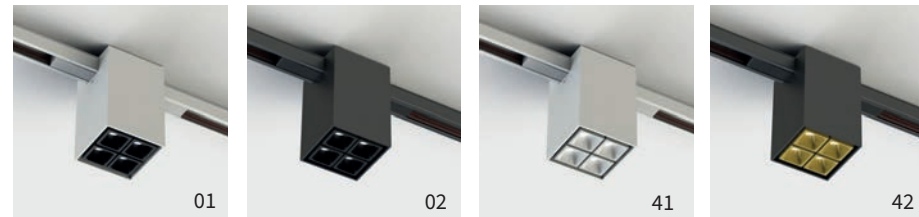

LED 24V e 48V			Im prod./beam 3000K				CODE
W	Dim.	H	Kg	S20°	F32°	W50°	
8,8	70x70	110	0,80	800	745	662	CB002.9 ●●●/##

Binario non incluso / mini track not included

CUBOTTI PC MINI TRACK SOFFITTO | CEILING MINI TRACK

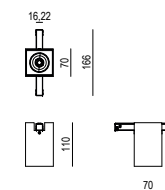
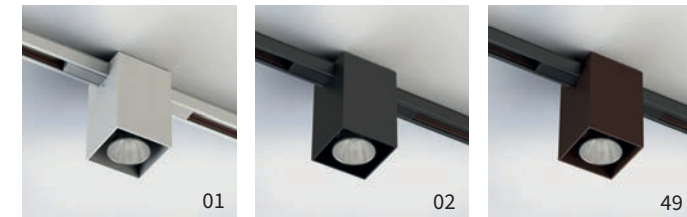

LED			Im prod./beam 3000K				CODE
W	mm	Hmm	Kg	F27°	W46°		
8	70x70	110	0,28	860	860		CB102.9 ●●●/##
12	70x70	110	0,28	1285	1285		CB104.9 ●●●/##

Binario non incluso / mini track not included

- KELVIN**
 - 27 2700K
 - 30 3000K
 - 35 3500K
 - 40 4000K
 - TW Tunable White
- FASCIO/BEAM**
 - S Spot 20°
 - F Flood 32°
 - W Wide 50°
- DIMMABLE (OPTIONAL)**
 - D Dali Touch & Dimm

Per la versione Dali scegliere un alimentatore ON OFF da posizionare remoto (per alimentare il binario).
For Dali version combine a ON OFF power supply to place remotely (for feed the track)

- FINITURA/FINISHING**
 - /01 telaio bianco, ottica nera | white frame, black optic
 - /02 telaio nero, ottica nera | black frame, black optic
 - /41 telaio bianco, ottica bianca | white frame, white optic
 - /42 telaio nero, ottica oro | black frame, gold optic

FINITURE PREMIUM DISPONIBILI / PREMIUM FINISHINGS ARE AVAILABLE

- KELVIN**
 - 27 2700K
 - 30 3000K
 - 35 3500K
 - 40 4000K
 - TW Tunable White Dali

- FASCIO/BEAM**
 - F Flood 27°
 - W Wide 46°

/ ## FINITURA/FINISHING

- /01 bianco/white
- /02 nero/black
- /49 bronzo / bronze

FINITURE PREMIUM /PREMIUM FINISHINGS

- /81 oro rosa/rose gold
- /82 bronzo anticato /antique bronze
- /83 ottone brunito spazzolato/ brushed burnished brass

48V DRIVERS VEDI | SEE "ALIMENTATORI" A PAGINA 452



LUCE INDIRETTA SU PROFILO "E" /
INDIRECT LIGHT ON "E" PROFILE

DIFFUSORE INDIRETTO IN POLICARBONATO OPALINO / INDIRECT OPAL WHITE POLYCARBONATE DIFFUSER

L.mm	Kg	CODE
1000	0.16	LT94P.1000
2000	0.33	LT94P.2000
3000	0.50	LT94P.3000

MINITRACK

ELEMENTI LUMINOSI/ LIGHT ELEMENTS

LINEA DI LUCE

LINEA DI LUCE DA 5 METRI/ LED LINE 5 METERS ROLL



Strip led ad alta efficienza con biadesivo e supporto di larghezza 8-12 mm su bobina da 5 metri, da alimentare con driver stabilizzati in tensione da 24Vdc. Classe di isolamento III. | High efficiency strip led with biadhesive and support of 8-12 mm wide on 5 meters roll. To be fed with 24Vdc voltage-stabilized driver. Insulation class III.

Linea di luce Led IP20 24V

W/m	V	Led/m	lm/m	lm/W	CRI	IP	Lmm	CODE	
4,8	24	120	620	129	90	20	5000	ST05.○.5	
9,6	24	160	1220	127	90	20	5000	ST10.○.5	
22	24	240	2700	123	90	20	5000	ST22.○.5	
16,8	24	COB	1400	2700-6500K	84	90	20	5000	ST22.TW.5

Linea di luce Led IP67 24V

W/m	V	Led/m	lm/m	lm/W	CRI	IP	Lmm	CODE
9,6	24	160	1073	111	90	67	5000	ST10.○.5IP
16,8	24	200	1822	108	90	67	5000	ST18.○.5IP

Linea di luce RGB- RGBW24V

W/m	V	Led/m	lm/m	type	cut	IP	Lmm	CODE
19,2	24	COB	640	RGBW 2700K	33,3	20	5000	ST19.2.RGBW.5
19,2	24	COB	655	RGBW 3000K	33,3	20	5000	ST20.RGBW.5
19,2	24	COB	540	RGBW 2700K	33,3	67	5000	ST19.RGBW.5IP
25+22,5	24	270	4100	RGB + White 3500K	55,4	20	5000	ST19.RGBW.5

CUTS

IP20

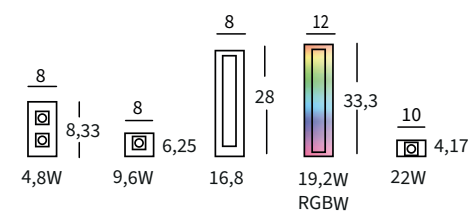

IP67

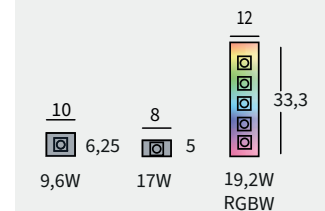

VERSIONI DISPONIBILI/AVAILABLE VERSION

○ KELVIN

- 27 2700K
- 30 3000K
- 35 3500K
- 40 4000K

COMPOSIZIONE CODICE: xxx.x ○ /##

HOW TO CREATE THE CODE: F1000.827/01

CODE

F1000.8 ○ /## — finishing

base code kelvin



DRIVERS VEDI | SEE P.452 24V

OUTDOOR

SKYLINE P.340 **NEW**



INCASSI | DOWNLIGHTER

NOTTE SYSTEM P.341 **NEW**

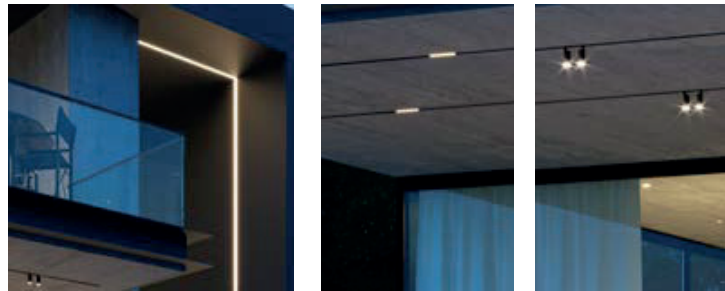

IGROUND P.379

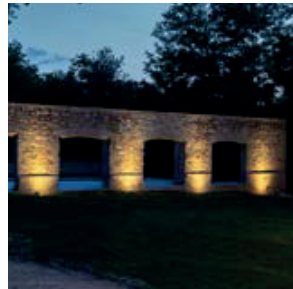

NYX P.385

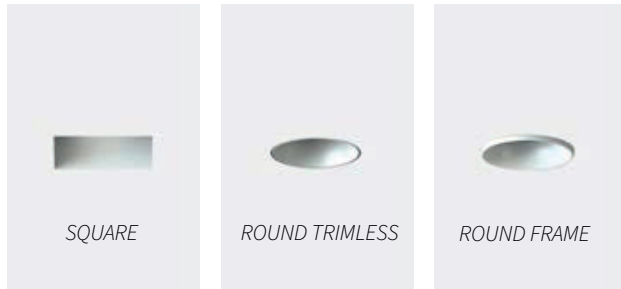
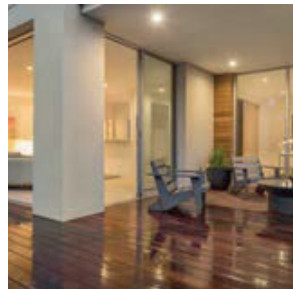

STEP P.395

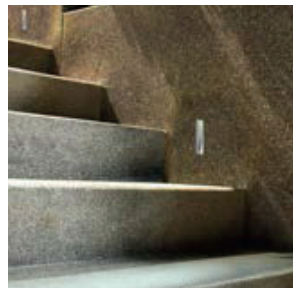

LEVA P.439

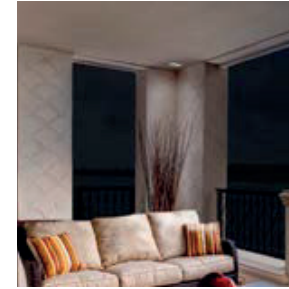

TERRA | FLOOR

FILE FLEX P.351

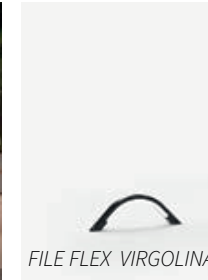

IFERROSI P.361

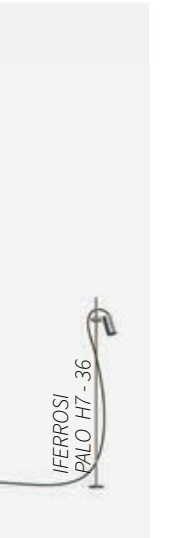
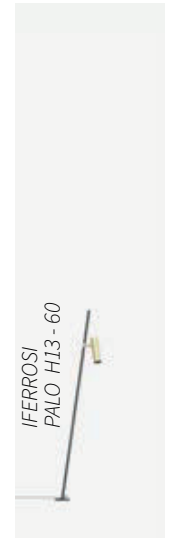

ICEMENTI COLLECTION P.405



NANOFIL P.399



OUTDOOR

PARETE - SOFFITTO | WALL - CEILING

IFERROSI P.361



SPOT 120 + CBL



SPOT 60 + CBL

IRIDE P.411



MANINE P.417



ANGOLO INTERNO



ANGOLO ESTERNO



PIATTE

ICEMENTI COLLECTION P.405

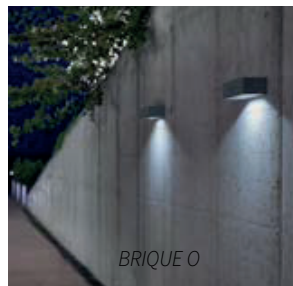

BRIQUE O



BRIQUE V

AURA OUT P.425 **NEW**

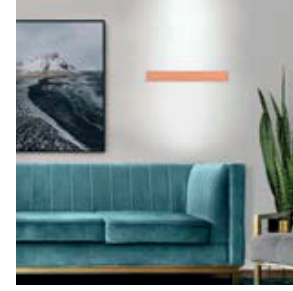

IPIEDI P.429

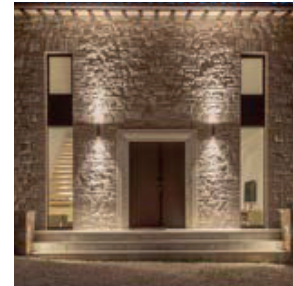

LEVA P.444

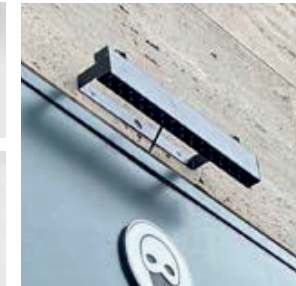

FILE 2 P.448



PARETE-TERRA | WALL-FLOOR

IFERROSI P.361 **NEW**

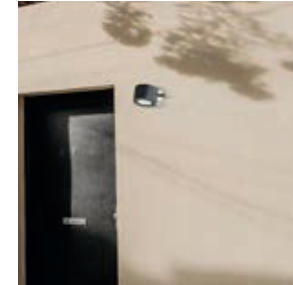

BUCOLICA P.343 **NEW**



ARBOREA P.348 **NEW**



PHAR P.422



SOSPENSIONE | SUSPENSION

IFERROSI P.361 **NEW**

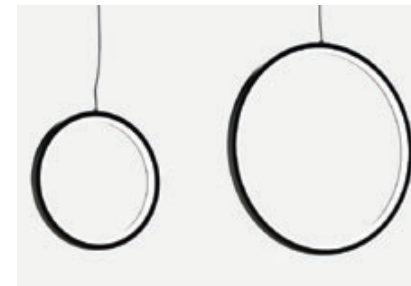

NYX

Trimless recessed system 40 mm
+ FOCUS and LEVA

STEP

Trimless recessed system
78 mm

NANOFILE

NOTTE SYSTEM

OUTDOOR COLLECTION

Notte System è un sistema modulare studiato per illuminare l'architettura. Pareti esterne sia verticali che orizzontali, a laterizio, calcestruzzo, cappotti, soffitti e controsoffitti. Il sistema dispone di due profili da 40 mm o 78 mm ai quali possono essere integrati diversi elementi luminosi: sorgente lineare LED, reglette led ed elementi Spot della linea Focus, le linee antiglare della collezione LEVA offrono la possibilità di un'illuminazione d'accento. Grado di protezione IP66.

Night System is a modular system designed to illuminate architecture. Exterior walls both vertical and horizontal, brick, concrete, coats, ceilings and countertops. The system has two profiles 40 mm or 78 mm to which different light elements can be connected: LED linear source, LED reglette and Focus line Spot elements, the anti-glare lines of the LEVA collection offer the possibility of accent lighting. Degree of protection IP66.

LATERIZIO/BRICKWALL

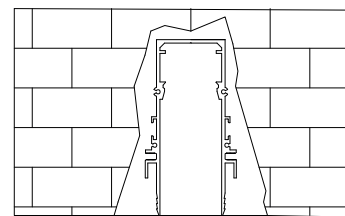

CALCESTRUZZO/CONCRETE

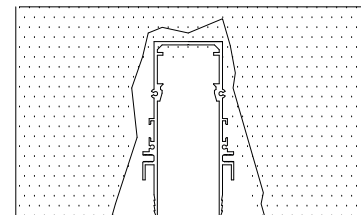

CAPPOTTO/COAT

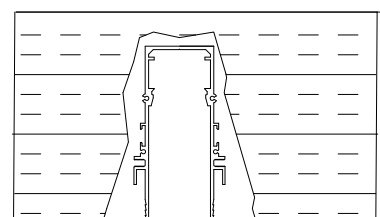

UK CONFORMITY ASSESSMENT E EUROPEAN CERTIFICATION / UK CONFORMITY ASSESSMENT AND EUROPEAN CERTIFICATION



PRODOTTI COSTRUITI CON MATERIALE RICICLABILE / PRODUCTS MADE OF RECYCLABLE MATERIAL



GARANZIA DI 5 ANNI / 5-YEAR WARRANTY

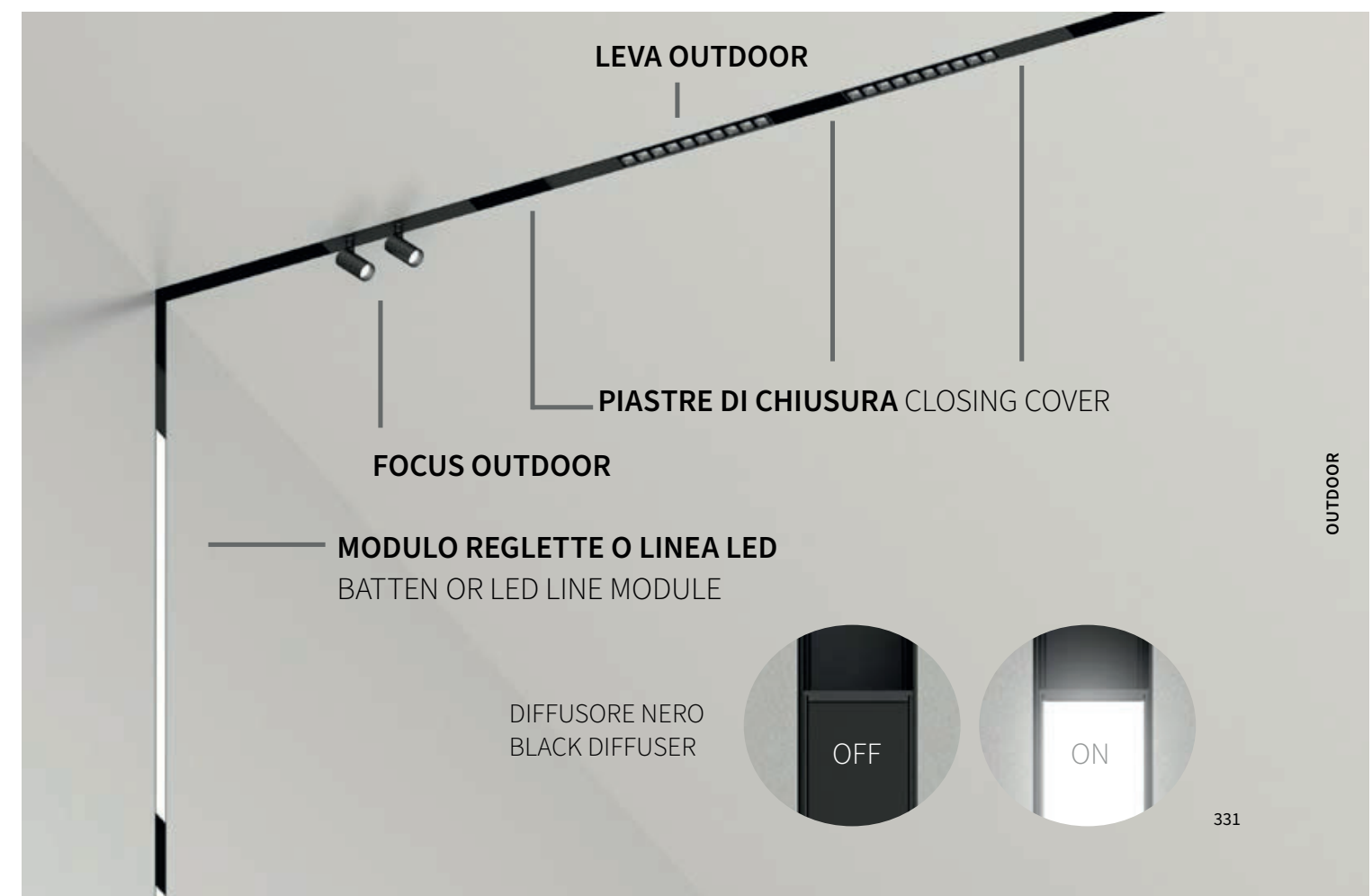

SISTEMA INCASSO RASATO 40 mm per laterizio, calcestruzzo e cappotto TRIMLESS RECESSED SYSTEM 40 mm for brickwall, concrete and coat

PROFILO VUOTO EMPTY PROFILE



Dim. H	Lmm	Kg	CODE	
57	98	1000	1.50	LTF1.1000/##
57	98	2000	3.10	LTF1.2000/##
57	98	3000	4.75	LTF1.3000/##
57	98			LTF1.misura/##

DIFFUSORE BIANCO OPALINO OPAL DIFFUSER



Lmm	Kg	CODE
1000	0.16	LT239P.1000
2000	0.33	LT239P.2000
3000	0.50	LT239P.3000
-----		LT239P.misura

DIFFUSORE BLACK BLACK DIFFUSER



Lmm	Kg	CODE
1000	0.16	LT239PN.1000
2000	0.33	LT239PN.2000
3000	0.50	LT239PN.3000
-----		LT239PN.misura

GIUNTI LINEARI COPPIA LINEAR CONNECTORS



Kg	CODE
0.05	LT2482

COPPIA GIUNTI ANGOLARI ANGLE CONNECTOR COUPLE



CODE
LTM211.90

COPPIA STAFFE COUPLE FIXING BRACKETS

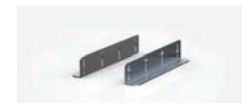

CODE
LTSC01

Coppia di staffe di fissaggio per cartongesso 1 ogni 1,5 mt. - | couple of fixing brackets in the false-ceiling 1 per 0,5 mt.



COPPIA DI TESTATE COUPLE OF CLOSURE HEADS

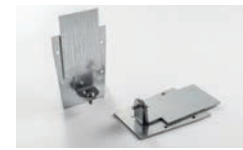

per cartongesso / for plasterboard
per laterizio / for brickwall

CODE
LT2480/##
LT2480.1

PIASTRA DI CHIUSURA CLOSING COVER



Molle incluse/ springs included	Lmm	CODE
n. 2	1000	F16.1000/##
n. 3	2000	F16.2000/##
n. 4	3000	F16.3000/##
-----		F16.misura/##

In caso di tagli ordinare altre molle/in case of cut order more springs

MOLLA PER PIASTRA SPRING FOR CLOSING COVER



Una ogni 70 cm da ordinare solo in caso di tagli della piastra di chiusura / One every 70 cm to order just in case of cut of the closing cover.

CODE
F1.MLC

FASCETTA REGGICAVO TIE CABLE LOCKING



CODE
LTSC03

Fascetta reggicavo - ordinare 1 ogni 0,5 mt (minimo 2pezzi) | Tie cable locking order 1 per 0,5 mt. (min.2pcs)

ELEMENTI LUMINOSI PER SISTEMA 40 mm LIGHTING FIXTURES FOR SYSTEM 40 mm

MODULO LEVA 3 / 3 LAMPS MODULE

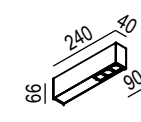

W	Kg	S20°	F32°	W50°	Z41°x18°	CODE
6,6	2	601	558	496	526	LV152IP.9 ●●●/##

Im product/beam 3000K

Ordinare la piastra a copertura dell'alimentatore | Order the plate to cover the power supply

MODULO LEVA 5 / 5 LAMPS MODULE

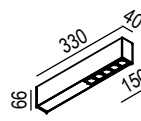

W	Kg	S20°	F32°	W50°	Z41°x18°	CODE
11	2,80	1002	931	828	877	LV153IP.9 ●●●/##

Im product/beam 3000K

Ordinare piastra a copertura dell'alimentatore | Order the plate to cover the power supply

MODULO LEVA 10 / 10 LAMS MODULE

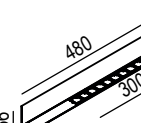

W	Kg	S20°	F32°	W50°	Z41°x18°	CODE
22	4,30	2004	1862	1656	1754	LV154IP.9 ●●●/##

Im product/beam 3000K

FOCUS 1 LUCE

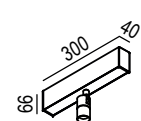

LED	W	ø	H	Lmm	Kg	S19°	F28°	Z18°x38°	CODE
8	36	85	300x38	0.47	665	695	508	FR040IP.9 ●●●/##	

Im product/beam 3000K

● Disponibili solo fascio S, F, Z | Available only S, F, Z beam

FOCUS 2 LUCI



LED	W	ø	H	Lmm	Kg	S19°	F28°	Z18°x38°	CODE
2x8	36	85	300x38	0.70	1330	1390	1016	FR041IP.9 ●●●/##	

Im product/beam 3000K

● Disponibili solo fascio S, F, Z | Available only S, F, Z beam

FILE SISTEMA REGLETTE LED 24W/M / 24W/M LED BATTEN



LED 24W/m	W	Lmm	with opal diffuser	CODE
12,8	740	721	NOR1.9** ●●●	
19,2	1030	1082	NOR2.9 ●●●	
25,6	1300	1442	NOR3.9 ●●●	
32	1630	1803	NOR4.9 ●●●	

Im product 3000K/diffuser

** Attenzione: non abbinare le reglette dimmerabili 560mm alle altre reglette di misura superiore perché potrebbero avere un comportamento differente durante la dimmerazione. | ** Attention: do not combine dimmable modules 560mm with other larger modules because they might have different dimming results.

Alimentatore incluso | Driver included

VERSIONI DISPONIBILI/AVAILABLE VERSION

○ KELVIN	● FASCIO/BEAM	● DIFFUSER	● DIMMABLE (OPTIONAL)	## FINITURA LEVA/LEVA FINISHING
27 2700K	S Spot	P bianco/white	D Dali	/01 paratia bianca, ottica nera/white plate, black optic
30 3000K	F Flood	N nero/black		/02 paratia nera, ottica nera/black plate, black optic
40 4000K	W Wide			/41 paratia bianca, ottica bianca/plate heads, white optic
	Z Asymmetric			/45 paratia moka, ottica oro/moka plate, gold optic
				## FINITURA FOCUS/ FOCUS FINISHING
				/01 bianco/white
				/02 nero/black
				/49 bronzo/bronze

Per i gradi vedere in tabella - For degree check the table



SISTEMA SOFFITTO/INCASSO/INCASSO RASATO 40 mm per controsoffitti e soffitti CEILING/ RECESSED /TRIMLESS RECESSED SYSTEM 40 mm for ceiling and false ceiling

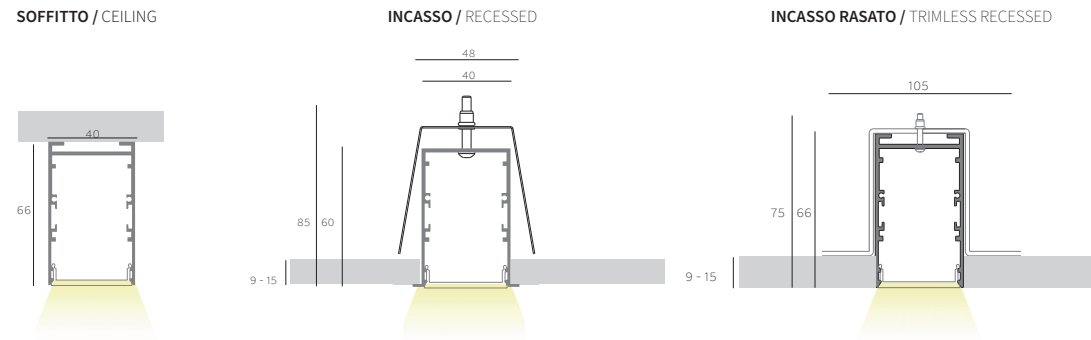

PROFILO VUOTO SOFFITTO / CEILING EMPTY PROFILE

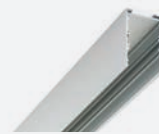

Kg	CODE	Col.
0,95	LT243.1000	/01
2,00	LT243.2000	/02
2,60	LT243.3000	/27
	LT243.misura	/49

COPPIA DI TESTATE / COUPLE OF CLOSURE HEADS



CODE
LT2403

COPPIA GIUNTI ANGOLARI / ANGLE CONNECTORS COUPLE



CODE
LTM211.90

COPPIA GIUNTI LINEARI / LINEAR CONNECTORS COUPLE



CODE
LT2406

COPPIA GIUNTI ANGOLARI PARETE-SOFFITTO / ANGLE CONNECTORS COUPLE WALL-CEILING



CODE
LTM211.90P

PROFILO VUOTO INCASSO / RECESSED EMPTY PROFILE



Lmm	Kg	CODE	Col.
1000	0,93	LT247.1000	/01
2000	1,86	LT247.2000	/02
3000	2,79	LT247.3000	/27
		LT247.misura	

COPPIA DI TESTATE / COUPLE OF CLOSURE HEADS



CODE Col.
LT2470 /01
/02
/27

GIUNTI LINEARI COPPIA / LINEAR JOINT COUPLE FOR WALLBOX



CODE
LT2482

MOLLA DI FISSAGGIO / FIXING SPRING



CODE
LT2426

Molla singola per fissare il profilo lineare al controsoffitto. Una ogni metro, minimo 2 | Single spring for fixing the linear profile on the false-ceiling. One every meter, 2 pieces minimum.

PROFILO VUOTO INCASSO RASATO / TRIMLESS RECESSED EMPTY PROFILE

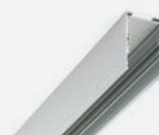

Lmm	Kg	CODE	Col.
1000	0,95	LT248.1000	/01
2000	2,00	LT248.2000	
3000	2,60	LT248.3000	
		LT248.misura	

COPPIA DI TESTATE / COUPLE OF CLOSURE HEADS



CODE
LTM248/01

STAFFA DI FISSAGGIO PROFILO / FIXING BRACKET FOR



CODE
LT248S

Staffa singola per fissare il profilo lineare al controsoffitto. Una ogni metro, minimo 2 | Single bracket for fixing the linear profile on the false-ceiling. One every meter, 2 pieces minimum.

GIUNTI LINEARI COPPIA / LINEAR JOINT COUPLE FOR WALLBOX



CODE
LT2482

ELEMENTI FINITI LUMINOSI PER PROFILO 40 mm LIGHTING FIXTURES FOR SYSTEM 40 mm

MODULO LEVA 3 / 3 LAMPS MODULE

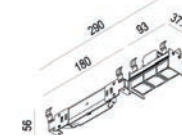

W	Kg	S20°	F32°	W50°	Z41°X18°	CODE
6,6	2	601	558	496	526	LV152P.9 ●●●/##

Ordinare la piastra a copertura dell'alimentatore | Order the plate to cover the power supply

MODULO LEVA 5 / 5 LAMPS MODULE

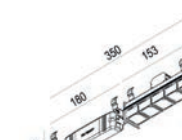

W	Kg	S20°	F32°	W50°	Z41°X18°	CODE
11	2,80	1002	931	828	877	LV153P.9 ●●●/##

Ordinare piastra a copertura dell'alimentatore | Order the plate to cover the power supply

MODULO LEVA 10 / 10 LAMS MODULE

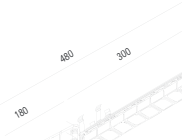

W	Kg	S20°	F32°	W50°	Z41°X18°	CODE
22	4,30	2004	1862	1656	1754	LV158P.9 ●●●/##

Ordinare piastra a copertura dell'alimentatore | Order the plate to cover the power supply

FOCUS 1 LUCE

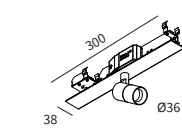

LED	W	ø	H	Lmm	Kg	S19°	F28°	Z18°x38°	CODE
	8	36	85	300x38	0,47	665	695	508	FR040P.9 ●●●/##

● Disponibili solo fascio S, F, Z | Available only S, F, Z beam

FOCUS 2 LUCI

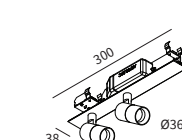

LED	W	ø	H	Lmm	Kg	S19°	F28°	Z18°x38°	CODE
	2x8	36	85	300x38	0,70	1330	1390	1016	FR041P.9 ●●●/##

● Disponibili solo fascio S, F, Z | Available only S, F, Z beam

VERSIONI DISPONIBILI / AVAILABLE VERSION

- KELVIN
 - 27 2700K
 - 30 3000K
 - 40 4000K
- FASCIO/BEAM
 - S Spot
 - F Flood
 - W Wide
 - Z Asymmetric
- DIMMABLE (OPTIONAL)
 - D Dali

Per i gradi vedere in tabella - For degree check the table

/## FINITURA PROFILI / FINISHING PROFILE

- /01 bianco/white
- /02 nero/black
- /27 alluminio anodizzato/ anodized aluminium
- /49 bronzo/bronze

COMPOSIZIONE CODICE: xxx.x●●●/##

HOW TO CREATE THE CODE: F1000.827S/01

CODE
F1000.8
| base code | kelvin | beam | dimmable | finishing

FINITURA / FINISHING

- /01 paratia bianca, ottica nera/white plate, black optic
- /02 paratia nera, ottica nera/black plate, black optic
- /41 paratia bianca, ottica bianca/plate heads, white optic
- /42 paratia nera, ottica oro/black plate, gold optic

OUTDOOR

FILE SISTEMA REGLETTE LED 24W/M / 24W/M LED BATTEN

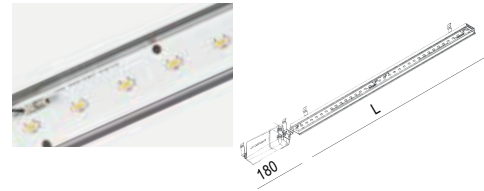

LED 24W/m			Im product:3000K/diffuser			CODE	
W	Lmm	with opal diffuser					
12,8	560+180	721				R18FM0IP.8**	●●
19,2	840+180	1082				R18FM1IP.8	●●
25,6	1120+180	1442				R18FM2IP.8	●●
32	1400+180	1803				R18FM3IP.8	●●

** Attenzione: non abbinare le reglette dimmerabili con 560 mm alle altre reglette di misura superiore perché potrebbero avere un comportamento differente durante la dimmerazione. | **Attention: do not combine dimmable modules with 560 mm with other larger modules because they might have different dimming results.

Alimentatore incluso | Driver included



LINEA DI LUCE DA 5 METRI/ LED LINE 5 METERS ROLL



IP67

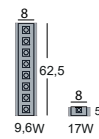

Linea di luce Led IP67 24V			Im/W			CRI IP		Lmm		CODE	
W/m	V	Led/m	Im/m								
9,6	24	160	1200	90	90	67	5000				ST10.0.5IP
17	24	200	2070	123	90	67	5000				ST18.0.5IP

Linea di luce RGB - RGBW 24V			Im/W			CUT		Lmm		CODE	
W/m	V	Led/m	Im/m	Beam	Type						
20W	24	120	540	RGB + White	2700K	100	5000				ST19.RGBW.5IP

Strip led ad alta efficienza con biadesivo e supporto di larghezza 8-12 mm su bobina da 5 metri, da alimentare con driver stabilizzati in tensione da 24Vdc. Classe di isolamento III. | High efficiency strip led with biadhesive and support of 8-12 mm wide on 5 meters roll. To be fed with 24Vdc voltage-stabilized driver. Insulation class III.



SISTEMA INCASSO RASATO 78 mm per laterizio, calcestruzzo e cappotti
TRIMLESS RECESSED SYSTEM 78 mm for brickwall, concrete and thermal coat

PROFILO VUOTO EMPTY PROFILE



Dim.	H	Lmm	CODE
95	107	1000	LTF2.1000/##
95	107	2000	LTF2.2000/##
95	107	3000	LTF2.3000/##
95	107		LTF2.misura*/##

COPPIA DI TESTATE COUPLE OF CLOSURE HEADS



		CODE	
da cartongesso for plasterboard		LT2890/##	
da laterizio/for brickwall		LT2890.1	

DIFFUSORE BIANCO OPALINO OPAL DIFFUSER

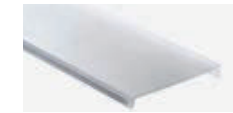

Lmm	CODE
1000	LT2506P.1000
2000	LT2506P.2000
3000	LT2506P.3000
	LT2506P.misura

PIASTRA DI CHIUSURA / CLOSING COVER



Molle include/ springs included		Lmm	CODE
n.2		1000	F26.1000/##
n.3		2000	F26.2000/##
n.4		3000	F26.3000/##
			F26.misura/##

GIUNTI LINEARI COPPIA LINEAR CONNECTORS



Kg	CODE
0.05	LT2482

MOLLA PER PIASTRA CHIUSURA / SPRING FOR CLOSING COVER



		CODE
		F2.MLC

Una ogni 70 cm da ordinare solo in caso di tagli della piastra di chiusura | One every 70 cm. To be ordered in case of cut of the closing cover.

COPPIA GIUNTI ANGOLARI ANGLE CONNECTOR COUPLE



		CODE
		LTM211.90

STAFFA SINGOLA FIXING SINGLE BRACKET



		CODE
		LT2891

COPPIA STAFFE DI FISSAGGIO COUPLE FIXING BRACKETS



		CODE
		LTSC01

staffa per fissaggio modulo luminoso all'interno della cassaforma. ordinare 1 al mt. (minimo 2 pezzi) | Single bracket to fix the lighting module within the wallbox, order 1 per mt. (min. 2 pcs)

Coppia di staffe di fissaggio per cartongesso 1 ogni 1,5 mt. - | couple of fixing brackets in the false-ceiling 1 per 0,5 mt.

FASCETTA REGGICAVO TIE CABLE LOCKING



		CODE
		LTSC04

Fascetta reggicavo - ordinare 1 ogni 0,5 mt (minimo 2pezzi) Tie cable locking - order 1 per 0,5 mt. (min.2pcs)

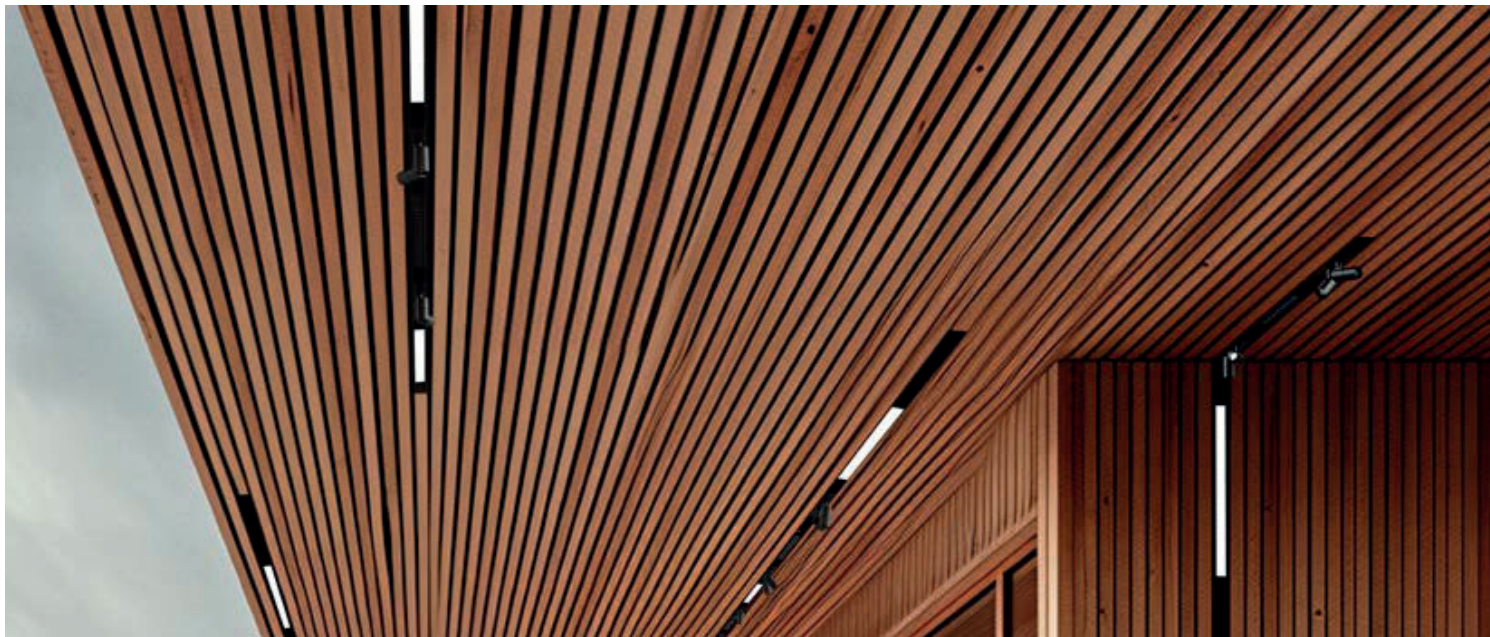

MODULI LUMINOSI - LIGHTING MODULES

LINEA DI LUCE DA 5 METRI/ LED LINE 5 METERS ROLL



IP67



Linea di luce Led IP67 24V			Im/W			CRI IP		Lmm		CODE	
W/m	V	Led/m	Im/m								
9,6	24	160	1200	90	90	67	5000				ST10.0.5IP
17	24	200	2070	123	90	67	5000				ST18.0.5IP

Linea di luce RGB - RGBW 24V			Im/W			CUT		Lmm		CODE	
W/m	V	Led/m	Im/m	Beam	Type						
20W	24	120	540	RGB + White	2700K	100	5000				ST19.RGBW.5IP

Strip led ad alta efficienza con biadesivo e supporto di larghezza 8-12 mm su bobina da 5 metri, da alimentare con driver stabilizzati in tensione da 24Vdc. Classe di isolamento III. | High efficiency strip led with biadhesive and support of 8-12 mm wide on 5 meters roll. To be fed with 24Vdc voltage-stabilized driver. Insulation class III.

VEDI SEE FILE 2 OUTDOOR



VERSIONI DISPONIBILI/AVAILABLE VERSION

- **KELVIN**
- 27 2700K
- 30 3000K
- 40 4000K
- **DIFFUSER**
- P bianco/white
- N nero/black

/ ## FINITURA/FINISHING

- /01 bianco/white
- /02 nero/black
- /27 alluminio anodizzato/ anodized aluminium
- /49 bronzo/bronze

COMPOSIZIONE CODICE: xxx.x ● /##
HOW TO CREATE THE CODE: **F1000.827/01**

CODE		/##		finishing	
F1000.8	●				
base code	kelvin				

DIFFUSORE NERO
BLACK DIFFUSER



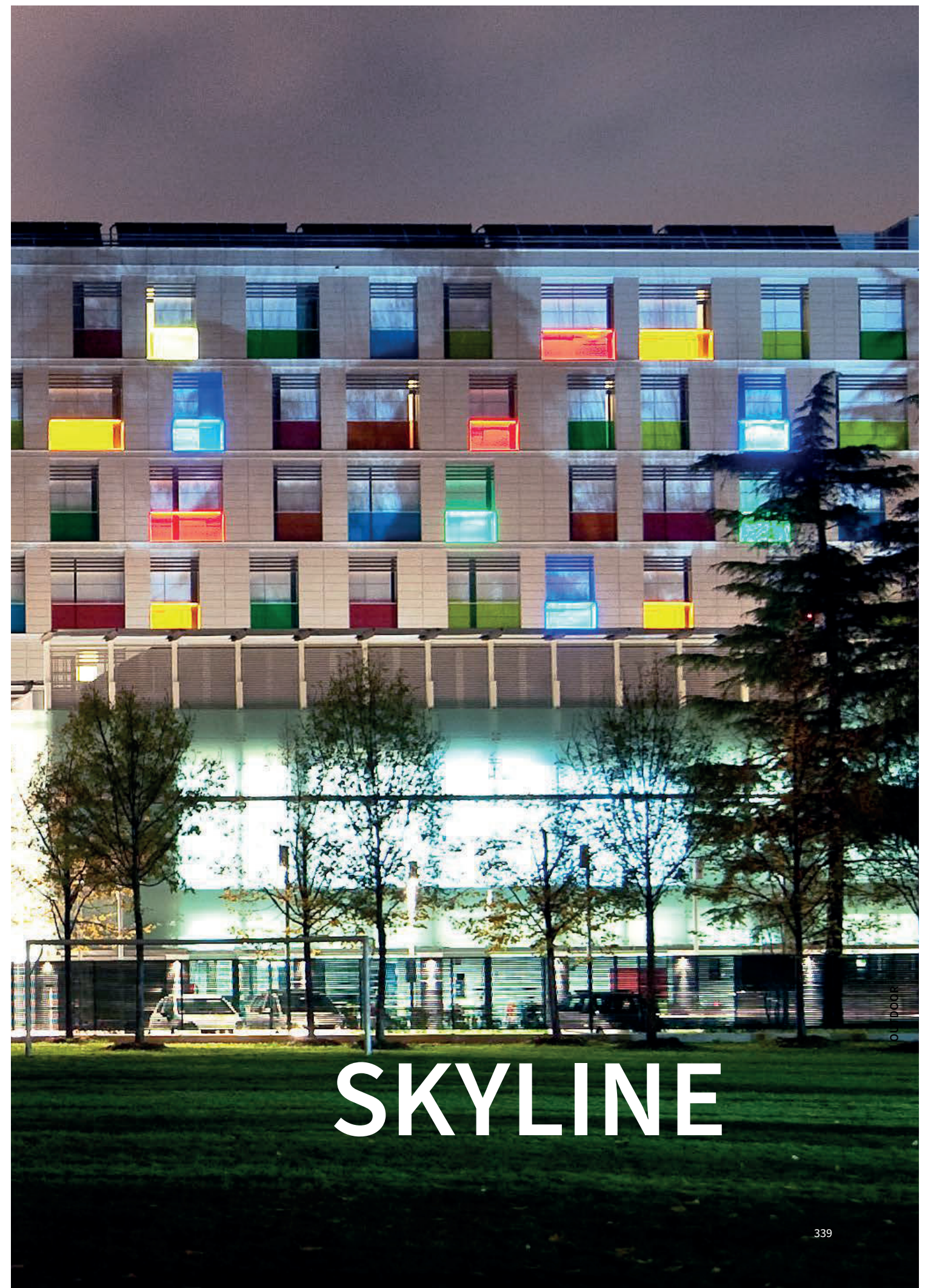

SKYLINE OUTDOOR COLLECTION

Skyline è un sistema di illuminazione studiato per illuminare i pannelli verticali di vetro che arredano l'architettura - costituiti da un profilo in estruso di alluminio. Sono disponibili versioni con sorgente lineare LED con schermo in estruso in silicone flessibile opale per luce diffusa. Grado di protezione IP66.

Skyline is a lighting system designed to illuminate the vertical glass panels that furnish the architecture - consisting of an extruded aluminum profile. Versions with linear LED source with extruded screen in opal flexible silicone for diffuse light are available. Degree of protection IP66.

UK CA CE UK CONFORMITY ASSESSMENT E EUROPEAN CERTIFICATION / UK CONFORMITY ASSESSMENT AND EUROPEAN CERTIFICATION

PRODOTTI COSTRUITI CON MATERIALE RICICLABILE / PRODUCTS MADE OF RECYCLABLE MATERIAL

5 **GARANZIA DI 5 ANNI / 5-YEAR WARRANTY**

FINITURE/FINISHINGS

**/27 ALLUMINIO ANODIZZATO/
ANODIZED ALUMINIUM**



PROFILO PROFILE

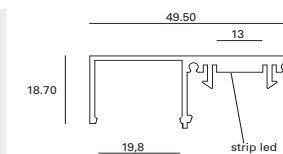
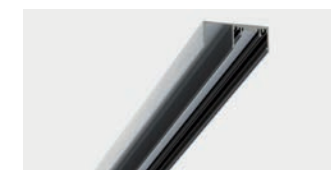

L.mm	CODE
1000	SKL00.1000/27
2000	SKL00.2000/27
3000	SKL00.3000/27
-----	SKL00.misura/27

COPPIA DI TESTATE COUPLE OF HEADS



CODE
SKL00TP/27

LENTI ACIDATE ACIDATED LENSES



L.mm	beam	CODE
1000	30°	SKL00L30.1000
2000	30°	SKL00L30.2000
3000	30°	SKL00L30.3000

MODULI LUMINOSI - LIGHTING MODULES

LINEA DI LUCE DA 5 METRI/ LED LINE 5 METERS ROLL

24V **CRI >90** **UK CA CE**



Linea di luce Led IP67 24V		lm/W CUT		CRI IP	L.mm	CODE	
W/m	V	Led/m	lm/m				
9,6	24	160	1073	111 6,25 90 67 5000		ST10.O.5IP	
16,8	24	200	1822	108 5 90 67 5000		ST18.O.5IP	
Linea di luce RGB - RGBW 24V		lm/W CUT		Type	IP	L.mm	CODE
W/m	V	Led/m	lm/m				
19,2	24	120	540	RGBW 2700K	33,3 67 5000		ST19.RGBW.5IP

Strip led ad alta efficienza con biadesivo e supporto di larghezza 8-12 mm su bobina da 5 metri, da alimentare con driver stabilizzati in tensione da 24Vdc. Classe di isolamento III. | High efficiency strip led with biadhesive and support of 8-12 mm wide on 5 meters roll. To be fed with 24Vdc voltage-stabilized driver. Insulation class III.

VERSIONI DISPONIBILI/AVAILABLE VERSION

- O** KELVIN
- 27 2700K
- 30 3000K
- 35 3500K
- 40 4000K
- TW Tunable white

COMPOSIZIONE CODICE: xxx.x O /##
HOW TO CREATE THE CODE: **F1000.827/01**

CODE
F1000.8 /## — finishing
| |
base code kelvin

24V DRIVERS VEDI | SEE P.452

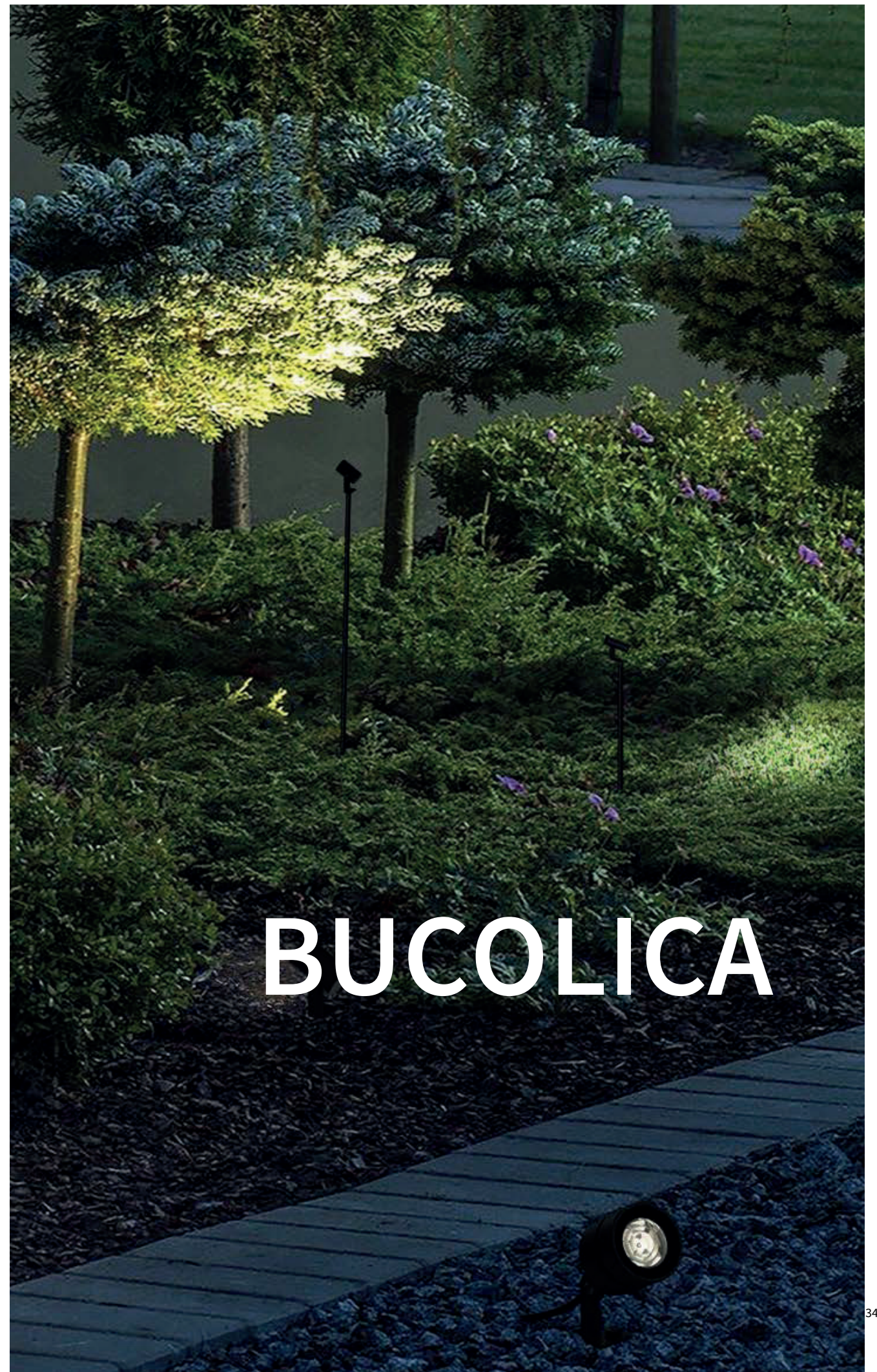

BUCOLICA



BUCOLICA

Collezione di proiettori da esterno costituiti da un corpo in alluminio ed un supporto regolabile in acciaio, disponibile in diversi diametri 26/36/60/120 mm personalizzabili con una serie di accessori che ne permettono diversi tipi di installazione. Idonei per fissaggio a terra o parete. Accessori disponibili : cover taglio dritto o obliquo, steli e picchetti per il fissaggio su prato. Sorgente LED integrata. Grado di protezione IP66.

Collection of outdoor projectors made of an aluminum body and an adjustable steel support, available in different diameters 26/36/60/120 mm customizable with a series of accessories that allow different types of installation. Suitable for ground or wall mounting. Available accessories : straight or oblique cut cover, stems and pegs for fixing on lawn. Integrated LED source. IP66 degree of protection.

CURVE FOTOMETRICHE/ PHOTOMETRIC DATA

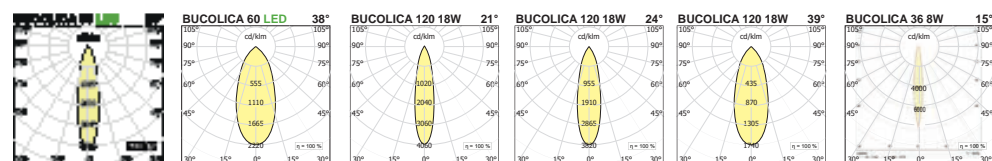

BUCOLICA SPOT 26

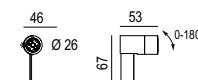

500 700 IK08 LED IP66 CRI >90 5 UK CE

LED		Im product/beam 3000K			CODE
W	mA	ø	H	F27°	
2,2	700	26	67		BU000.9 ●● /02
5,7	500	26	67	571	BU001.9 ●● /02
500 AE500.14IP		700 AE700.14IP			

● disponibile solo fascio S e F available only S and F beam
L'apparecchio è dotato di 2 m di cavo | 2 m of cable included.
Accessori - accessories: BU026/## Monocolo obliquo Oblique mococle

BUCOLICA SPOT 36

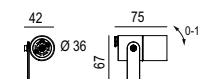
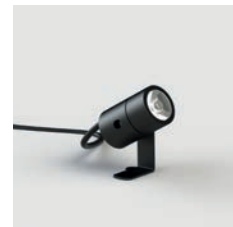

700 IK08 LED IP66 CRI >90 5 UK CE

LED		Im product/beam 3000K			CODE
W	mA	ø	H	S15° F27°	
8	700	36	92	438 695	BU003.9 ●● /02
700 AE700.12IP					

L'apparecchio è dotato di 2 m di cavo | 2 m of cable included.
Accessori - accessories: BU036/## Monocolo obliquo Oblique mococle BU035 Palo, Pole BU034 Picchetto / Stake

BUCOLICA SPOT 60

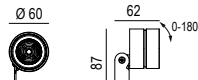

700 IK08 LED IP66 CRI >90 5 UK CE

LED		Im product/beam 3000K			CODE
W	mA	øspot	H	Kg	F24° W38°
6,7	700	60	200	0,8	650 712
700 AE700.12IP					

● disponibile solo fascio F e W available only F e W beam
L'apparecchio è dotato di 2 m di cavo | 2 m of cable included.
Accessori - accessories: BU031 Cover semplice / Simple cover BU120/## Cover obliqua/Oblique cover BU035 Palo/pole BU034 Picchetto / Stake

BUCOLICA SPOT 120

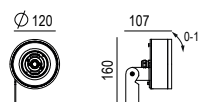
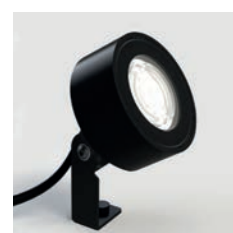

500 IK08 LED IP66 CRI >90 5 UK CE

LED		Im product/beam 3000K			CODE
W	mA	øspot	H	Kg	S21° F24° W39°
18	500	120	75	1,7	1642 1483 1473
500 AE500.22IP					

L'apparecchio è dotato di 2 m di cavo | 2 m of cable included.
Accessori - accessories: BU030 Cover semplice / Simple cover BU060/## Cover obliqua/Oblique cover BU035 Palo/pole BU034 Picchetto / Stake

VERSIONI DISPONIBILI/AVAILABLE VERSION

- **KELVIN**
 - 27 2700K
 - 30 3000K
 - 35 3500K
 - 40 4000K
- **FASCIO/BEAM**
 - S Spot
 - F Flood
 - W Wide
 - Z Asymmetric

Per i gradi vedere in tabella -
For degrees check the table

COMPOSIZIONE CODICE: xxx.x ●●

HOW TO CREATE THE CODE: F1000.827S

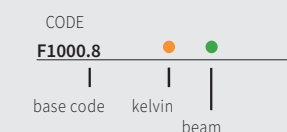

500 700 DRIVERS VEDI | SEE P.452 345



ACCESSORI | ACCESSORIES

COVER CON TAGLIO OBLIQUO | COVER WITH OBLIQUE CUT

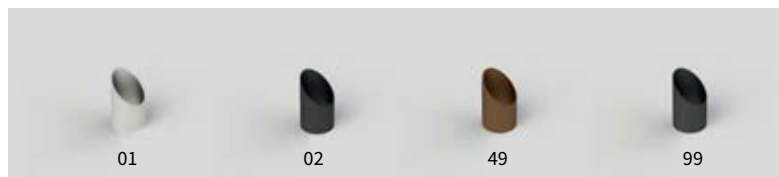
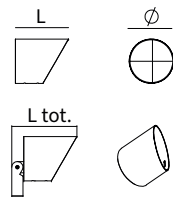

	L	Ltot	Ø	CODE
Bucolica 26	62	88	29	BU026/##
Bucolica 36	66	100	40	BU027/##
Bucolica 60	80	101	64	BU028/##
Bucolica 120	144	176	124	BU029/##

COVER SEMPLICE | SIMPLE COVER

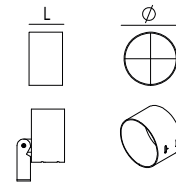

	Ø	Lmm	CODE
Bucolica 60	60	42	BU030/##
Bucolica 120	120	75	BU031/##

ACCESSORI PER IL FISSAGGIO AL TERRENO/TO INSTALL INTO THE GROUND

PALO 1200 CON BASE POLE 1200 WITH BASE



	Ø base	Ø	H	CODE
	120	18	1200	BU035 /99

Da abbinare al picchetto cod. BU034 optional | To be combined with optional picket code BU034

PICCHETTO CORTO | SHORT PICKET

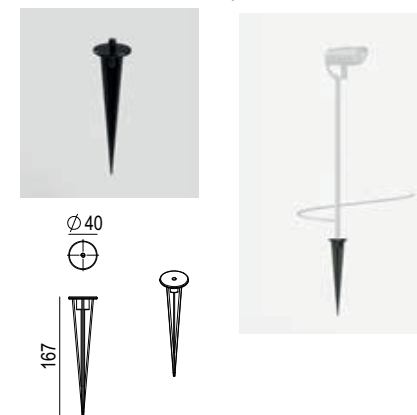

CODE
BU034

/## FINITURA/FINISHING

- /01 bianco | white
- /02 nero | black
- /49 bronzo / bronze
- /99 grafite | graphite

COMPOSIZIONE CODICE: xxx.x /##

HOW TO CREATE THE CODE: **F1000/01**

CODE
F1000 /## — finishing

|
base code

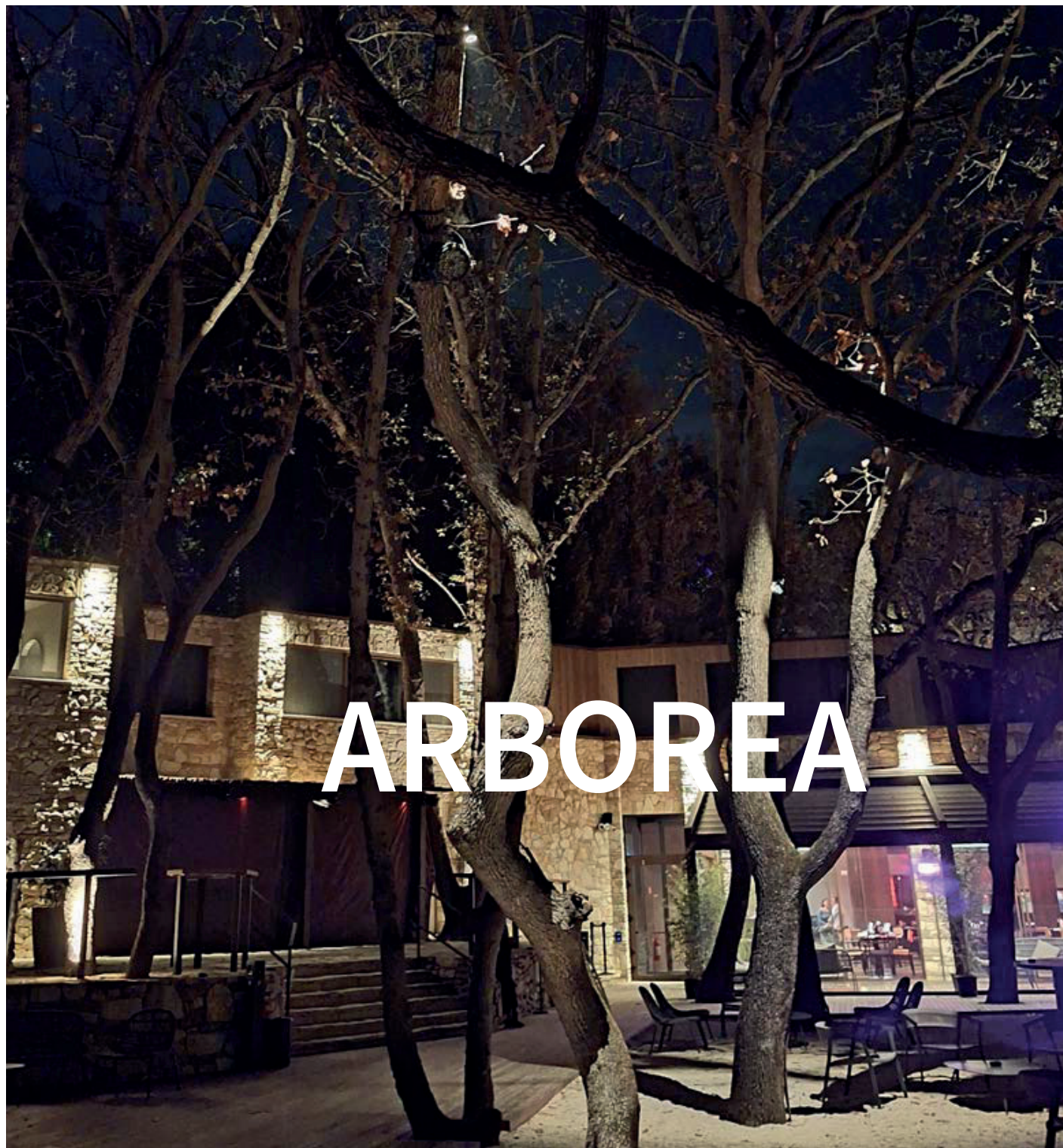

ARBOREA

Apparecchio studiato appositamente per l'illuminazione delle piante, costituito da un corpo in alluminio che può essere fissato a terra, ma, con la cinghia come accessorio si trasforma in apparecchio per il fissaggio agli alberi. Sorgente LED. Grado di protezione IP66.

Luminaire designed specifically for lighting plants, consisting of an aluminum body that can be fixed to the ground, but, with the strap, as an accessory, turns into an appliance for fixing to trees. LED source. Degree of protection IP66.

348



ARBOREA FLOOR



49

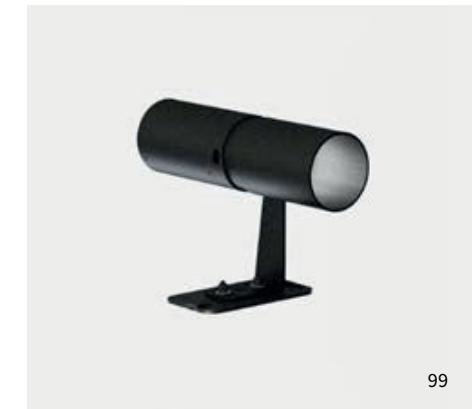

99

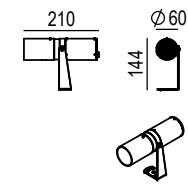

Linea di luce - LED line			Im prod. 3000K F24°	W38°	CODE
W	Ø	H			
6,7	60	144	650	712	AR000.9 ●●●/##

L'apparecchio è dotato di 2 m di cavo | 2 m of cable included.

ACCESSORI | ACCESSORIES

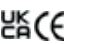

CINGHIA DI ANCORAGGIO AGLI ALBERI / ANCHOR FOR TREES STRAP



Lmm	CODE
1000	AR033

PICCHETTO CORTO | SHORT PICKET

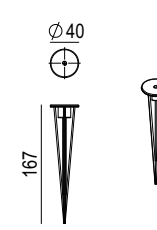

CODE
BU034

VERSIONI DISPONIBILI/AVAILABLE VERSION

● KELVIN

- 27 2700K
- 30 3000K
- 35 3500K
- 40 4000K

● FASCIO/BEAM

- F Flood
- W Wide

FINITURA/FINISHING

- /49 bronzo | bronze
- /99 grafite | graphite

● DIMMABLE (OPTIONAL)

D Dali

COMPOSIZIONE CODICE: xxx.x ●●●/##
HOW TO CREATE THE CODE: F1000.827S1/01

CODE				
F1000.8	●	●	●	/##
base code	kelvin	beam	dimmable	finishing

Per i gradi vedere in tabella -
For degrees check the table

349



FILE FLEX

**OUTDOOR
COLLECTION**

OUTDOOR

FILE FLEX

OUTDOOR COLLECTION

Famiglia di apparecchi illuminanti da esterno - da terra, a parete, a soffitto od a sospensione - costituiti da un profilo in estruso di alluminio dalle forme curvilinee. Sono disponibili versioni con sorgente lineare LED con schermo in estruso in silicone flessibile opale per luce diffusa e versioni con moduli LED multi ottica della serie Leva per luce d'accento. Grado di protezione IP66.

Family of outdoor lighting fixtures - floor, wall, ceiling or suspended - realized by extruded aluminum profiles with curvilinear shapes. Versions with LED linear source with extruded opal flexible silicone screen for diffused light and versions with multi-optic LED modules of the Leva series for accent lighting are available. IP66.



UK CONFORMITY ASSESSMENT E EUROPEAN CERTIFICATION / UK CONFORMITY ASSESSTMENT AND EUROPEAN CERTIFICATION



PRODOTTI COSTRUITI CON MATERIALE RICICLABILE / PRODUCTS MADE OF RECYCLABLE MATERIAL



GARANZIA DI 5 ANNI / 5-YEAR WARRANTY

FINITURE PREMIUM / PREMIUM FINISHINGS

- /81 ORO ROSA/ROSE GOLD
- /82 BRONZO ANTICATO/
ANTIQUE BRONZE
- /83 OTTONE BRUNITO SPAZZOLATO]-
BRUSHED BURNISHED BRASS

FINITURE STANDARD / STANDARD FINISHINGS

- /01 BIANCO/WHITE
- /02 NERO/BLACK
- /60 CORTEN
- /99 GRAFITE/GRAPHITE

CURVE FOTOMETRICHE / PHOTOMETRIC DATA

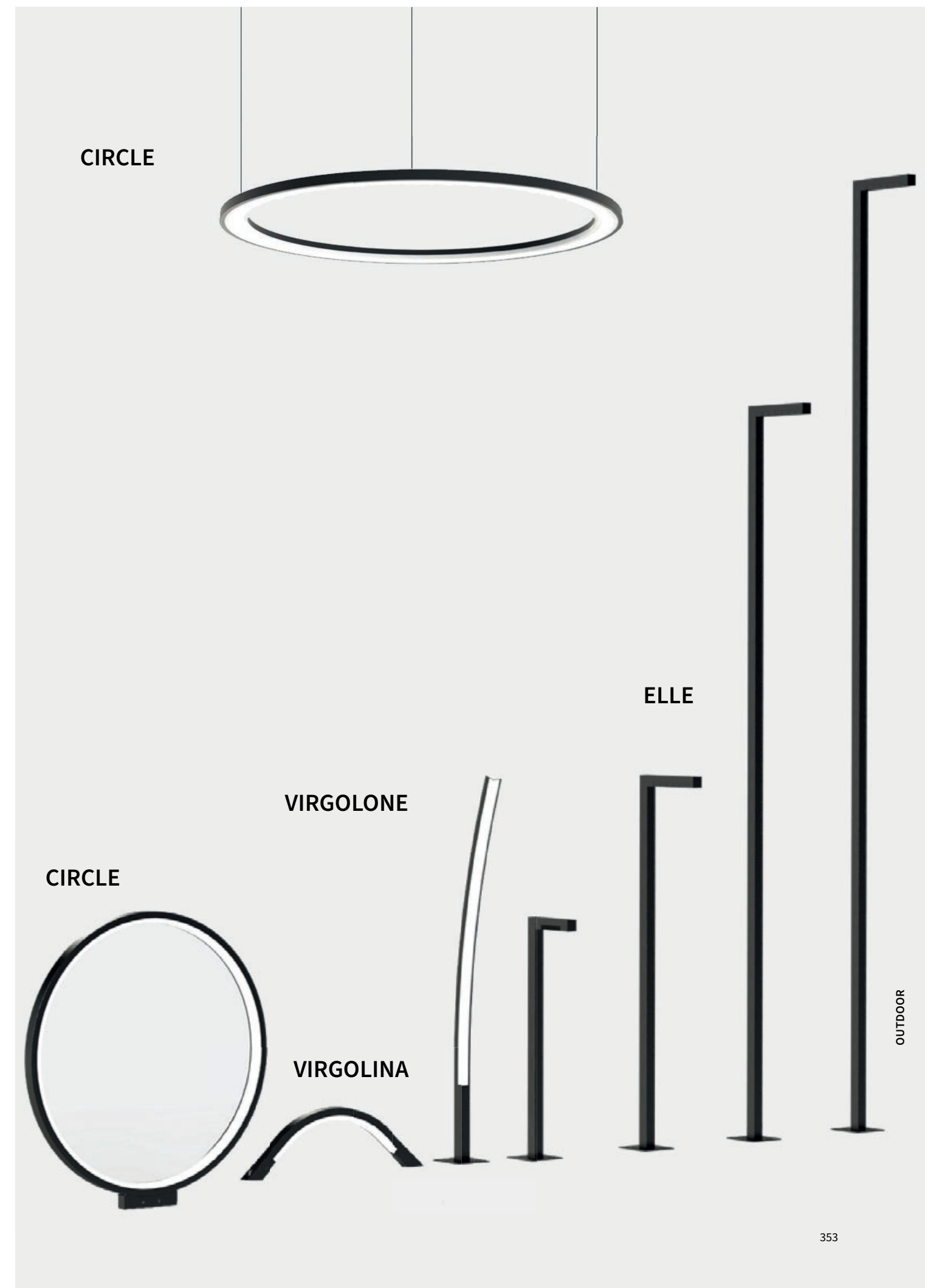
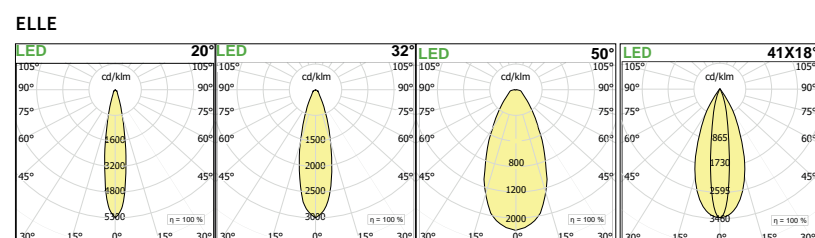
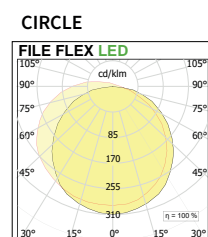
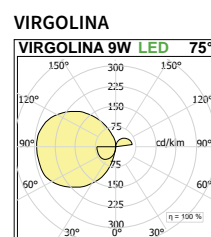

VIRGOLINA



24V IK08 LED IP65 CRI >90 A 5 ENEC

Linea di luce - LED line		W	Dim.	H	Kg	Im prod./3000K	CODE
9	520x34	170	1	265			FXG10.8 ● /##

Le finiture /01 e /02 sono testurizzate | Finishing referring to /01 and /02 are embossed
L'apparecchio è dotato di 2 m di cavo | 2 m of cable included.

VIRGOLONE

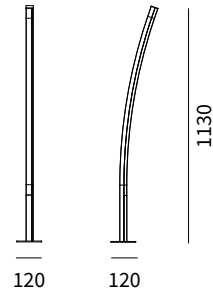

24V IK08 LED IP65 CRI >90 A 5 ENEC

Linea di luce - LED line		W	Dim.	H	Kg	Im prod./3000K	CODE
16,5	120x120	1130	3,2	515			FXG11.8 ● /##

Le finiture /01 e /02 sono testurizzate | Finishing referring to /01 and /02 are embossed
L'apparecchio è dotato di 2 m di cavo | 2 m of cable included.



CIRCLE "T"

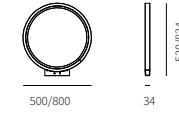

24V IK08 LED IP65 CRI >90 A 5 ENEC

Linea di luce - LED line		W	Ø	H	Kg	Im prod./3000K	CODE
27	500	530	2,8	866			FXG01.8 ● /##

Linea di luce - LED line		W	Ø	H	Kg	Im prod./3000K	CODE
44	800	834	4,3	1395			FXG02.8 ● /##

Le finiture /01 e /02 sono testurizzate | Finishing referring to /01 and /02 are embossed.
L'apparecchio è dotato di 2 m di cavo | 2 m of cable included.

CIRCLE "V"

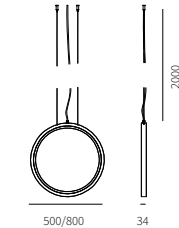

24V IK08 LED IP65 CRI >90 A 5 ENEC

Linea di luce - LED line		W	Ø	Kg	Im prod./3000K	CODE
27	500	2,8	866			FXG21.8 ● /##

Linea di luce - LED line		W	Ø	Kg	Im prod./3000K	CODE
44	800	4,3	1395			FXG22.8 ● /##

Le finiture /01 e /02 sono testurizzate | Finishing referring to /01 and /02 are embossed.

CIRCLE "O" DIFFUSED

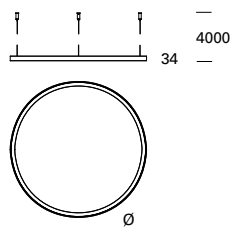

24V IK08 LED IP65 CRI >90 A 5 ENEC

LED	W	Ø	Kg	Im prod./3000K	CODE
33	500	2,5	1886		FXG41.8 ● /##
53	800	3,9	3068		FXG42.8 ● /##
67	1000	4,8	3860		FXG43.8 ● /##
81	1200	5,9	4666		FXG44.8 ● /##
101	1500	8,0	5880		FXG45.8 ● /##
121	1800	8,9	7068		FXG46.8 ● /##
169	2500	12,2	9867		FXG47.8 ● /##
203	3000	14,8	11887		FXG48.8 ● /##

CIRCLE "O" SPOT



24V IK08 LED IP65 CRI >90 A 5 ENEC

LED	W	Ø	Kg	Im product/beam 3000K			CODE
				20°	32°	50°	
33	500	2,4	3000	2793	2484		FXG51.9 ● /##
44	800	3,8	4000	3724	3312		FXG52.9 ● /##
66	1000	4,7	6000	5586	4968		FXG53.9 ● /##
77	1200	5,8	7000	6517	5796		FXG54.9 ● /##
88	1500	7,9	8000	7448	6624		FXG55.9 ● /##



VERSIONI DISPONIBILI/AVAILABLE VERSION

- **KELVIN**
 - 27 2700K
 - 30 3000K
 - 40 4000K
- **FASCIO/BEAM**
 - S Spot 20°
 - F Flood 32°
 - W Wide 50°

/## FINITURA/FINISHING

- /01 bianco/white
- /02 nero/black
- /60 cor ten
- /99 grafite/graphite

COMPOSIZIONE CODICE: xxx.x ● /##

HOW TO CREATE THE CODE: **F1000.827/01**
CODE
F1000.8 ● /## — finishing
base code kelvin



ELLE

SISTEMA DI FISSAGGIO | FIXING SYSTEM

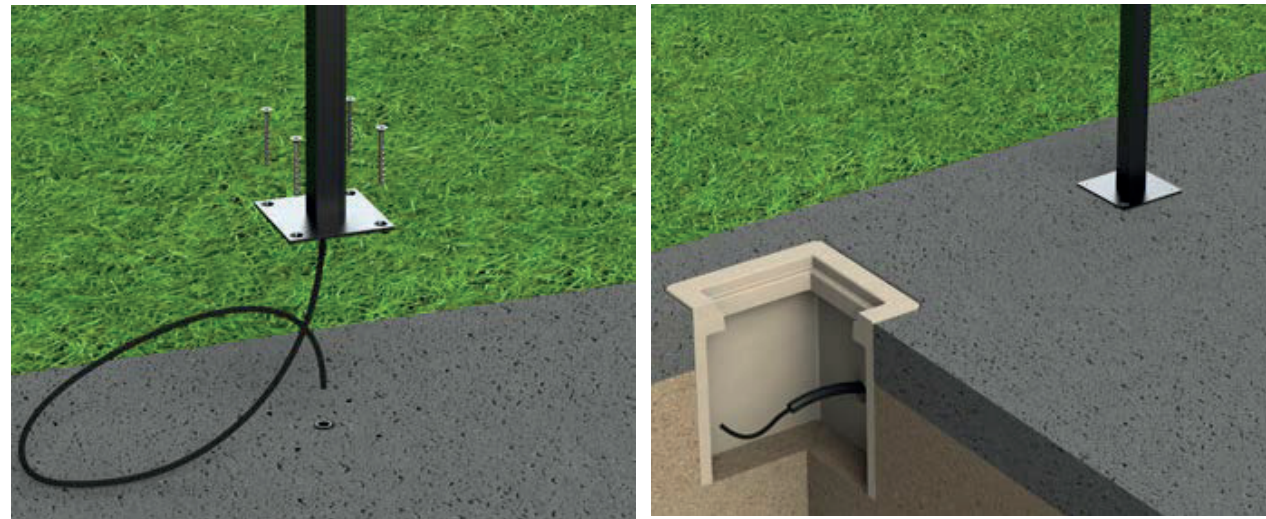

VERSIONI DISPONIBILI/AVAILABLE VERSION

● KELVIN

- 27 2700K
- 30 3000K
- 35 3500K
- 40 4000K

● FASCIO/BEAM

- S Spot
- F Flood
- W Wide
- Z Asymmetric

COMPOSIZIONE CODICE: xxx.x ● /##

HOW TO CREATE THE CODE: **F1000.827S /01**
CODE

F1000.8 ● ● /## finishing
base code kelvin beam

Per i gradi vedere in tabella -
For degrees check the table

/## FINITURA/FINISHING

- /01 struttura bianca, ottica nera | white structure, black optic
- /02 struttura nera, ottica nera | black structure, black optic
- /41 struttura bianca, ottica bianca | white structure, white optic
- /60 struttura corten, ottica nera | corten structure, black optic
- /99 struttura grafite, ottica nera | graphite structure, black optic

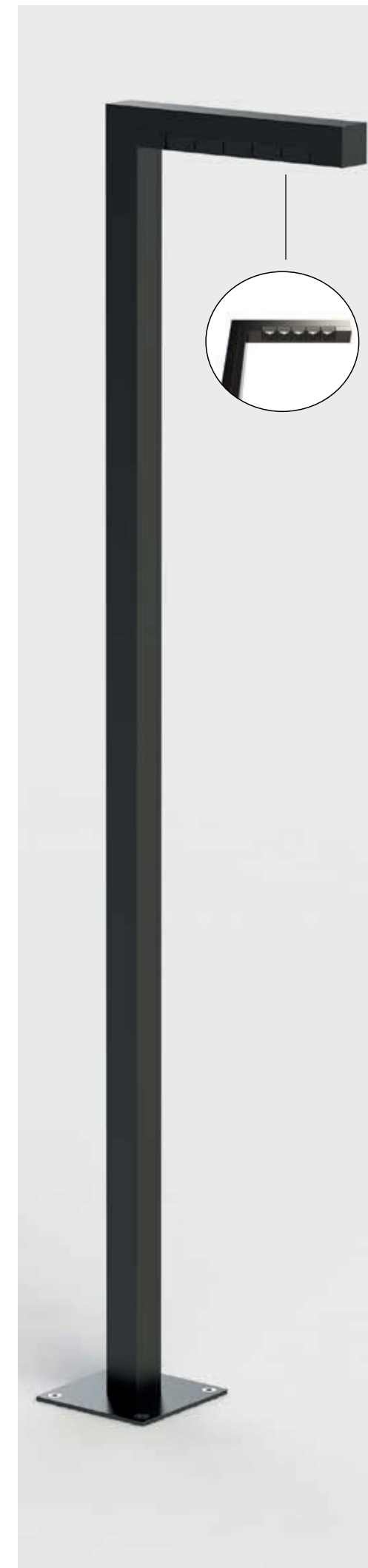

FILE FLEX OUTDOOR ELLE1											700	IK08	LED	UGR <14	IP56	CR1 >90	A	5	UK	CE
LED	W	mA	Dim.	H	Base	lm product/beam 3000K	S20°	F32°	W40°	Z41°x18°	CODE									
6,6	700	187X34	718	120x120	600	558	497	456			FXG31.9	●	●							
Le finiture /01 e /02 sono testurizzate Finishing referring to /01 and /02 are embossed L'apparecchio è dotato di 2 m di cavo 2 m of cable included.																				
FILE FLEX OUTDOOR ELLE2											700	IK08	LED	UGR <14	IP56	CR1 >90	A	5	UK	CE
LED	W	mA	Dim.	H	Base	lm product/beam 3000K	S20°	F32°	W40°	Z41°x18°	CODE									
11	700	247X34	1134	120x120	1000	931	828	760			FXG32.9	●	●							
Le finiture /01 e /02 sono testurizzate Finishing referring to /01 and /02 are embossed L'apparecchio è dotato di 2 m di cavo 2 m of cable included.																				
FILE FLEX OUTDOOR ELLE3											700	IK08	LED	UGR <14	IP56	CR1 >90	A	5	UK	CE
LED	W	mA	Dim.	H	Base	lm product/beam 3000K	S20°	F32°	W40°	Z41°x18°	CODE									
11	700	247X34	2264	120x120	1000	931	828	760			FXG33.9	●	●							
Le finiture /01 e /02 sono testurizzate Finishing referring to /01 and /02 are embossed L'apparecchio è dotato di 2 m di cavo 2 m of cable included.																				
FILE FLEX OUTDOOR ELLE4											700	IK08	LED	UGR <14	IP56	CR1 >90	A	5	UK	CE
LED	W	mA	Dim.	H	Base	lm product/beam 3000K	S20°	F32°	W40°	Z41°x18°	CODE									
15,4	700	307X34	2984	120x120	1387	1291	1148	1054			FXG34.9	●	●							
Le finiture /01 e /02 sono testurizzate Finishing referring to /01 and /02 are embossed L'apparecchio è dotato di 2 m di cavo 2 m of cable included.																				



360

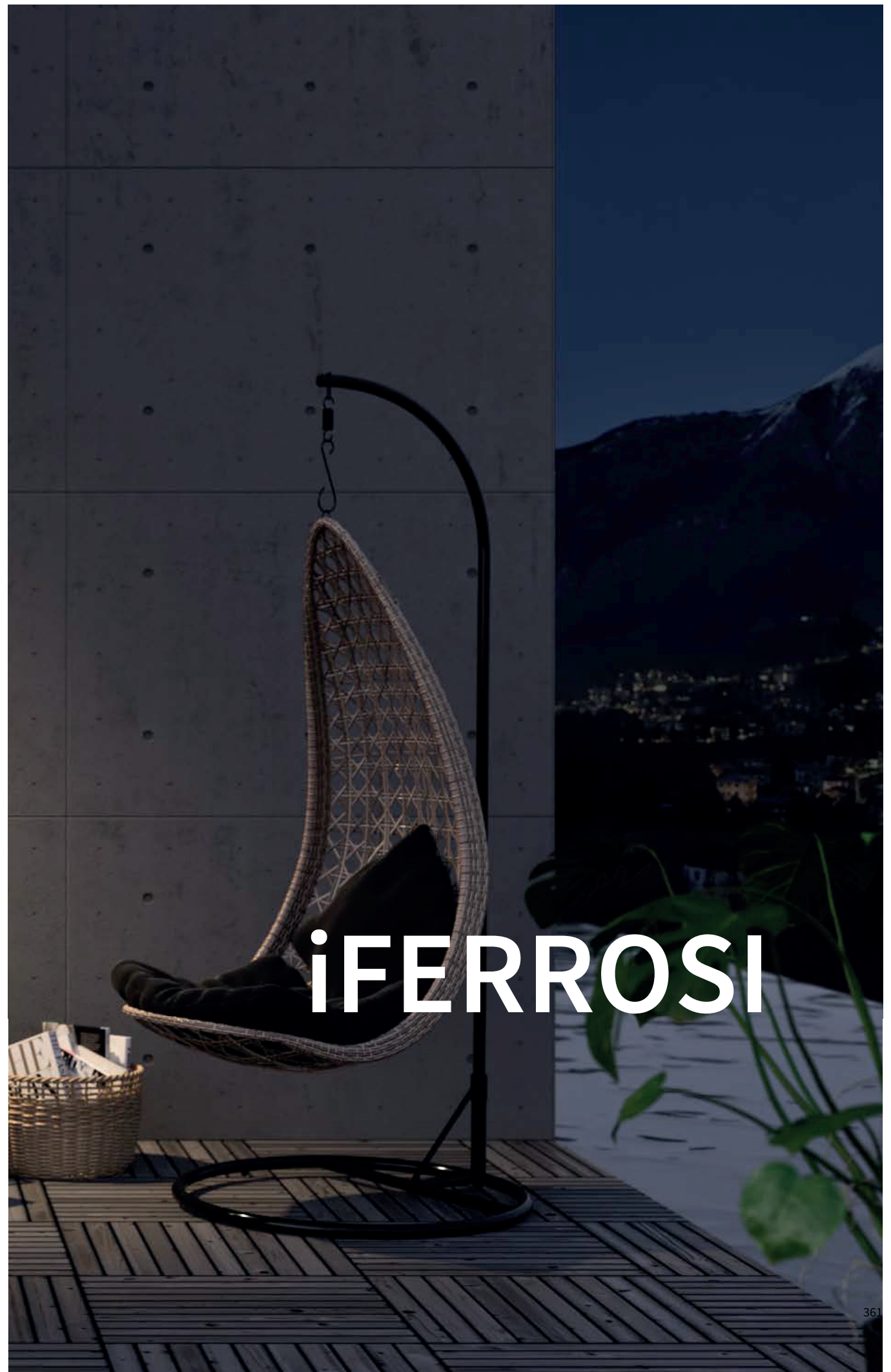

iFERROSI

361

OUTDOOR

La collezione de iFerrosi offre soluzioni versatili per l'illuminazione da terra o parete. Il sistema modulare offre massima personalizzazione, iFerrosi sono progettati per adattarsi alle esigenze specifiche del progetto e del progettista.

This collection offers versatile solutions for floor or wall lighting. The modular system offers maximum customization, iFerrosi are designed to adapt to the specific needs of the project and the designer.



IFERROSI

MODULI FINITI | DEFAULT MODULES

FLOOR



WALL & FLOOR

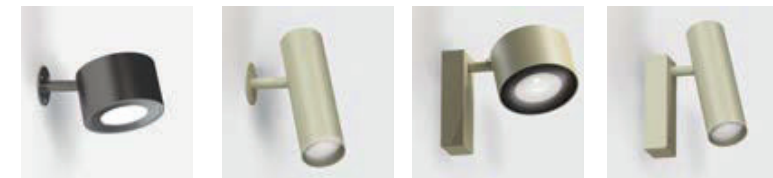

SISTEMA | SYSTEM



Famiglia di apparecchi illuminanti da esterno da terra o parete, proposti in moduli finiti o in sistema modulare per una massima personalizzazione. Sono disponibili versioni con sorgente LED per luce d'accento. Proposti pali di diverse altezze da 700mm a 3000mm, da abbinare a spot da 6,7W o 18W. Base d'appoggio oppure possibilità di fissaggio per diverse superfici: flangia per fissaggio su superfici legnose, zanca per fissaggio in calcestruzzo, picchetto per fissaggio su terra. Grado di protezione IP54.

Family of outdoor floor or wall luminaires, available in finished modules or in a modular system for maximum customization. Versions with LED source for accent light are available. Poles of different heights from 700mm to 3000mm are available, to be combined with spots of 6.7W or 18W. Fixing base or possibility to install in different surfaces: flange for wooden surfaces, clamp for concrete and stake for ground. IP54.



UK CONFORMITY ASSESSMENT E EUROPEAN CERTIFICATION / UK CONFORMITY ASSESSMENT AND EUROPEAN CERTIFICATION



PRODOTTI COSTRUITI CON MATERIALE RICICLABILE / PRODUCTS MADE OF RECYCLABLE MATERIAL



GARANZIA DI 5 ANNI / 5-YEAR WARRANTY

KELVIN	
27	2700°K
30	3000°K
35	3500°K
40	4000°K

FASCIO/BEAM

S	SPOT
F	FLOOD
W	WIDE

FINITURE STANDARD /STANDARD FINISHINGS

/44C	ORO CHAMPAGNE / CHAMPAGNE GOLD
/46	ORO CHAMPAGNE- GRAFITE / CHAMPAGNE GOLD - GRAPHITE
/99	GRAFITE/GRAPHITE

FINITURE PREMIUM /PREMIUM FINISHINGS

/81	ORO ROSA/ROSE GOLD
/82	BRONZO ANTICATO / ANTIQUE BRONZE
/83	OTTONE BRUNITO SPAZZOLATO / BRUSHED BURNISHED BRASS

CURVE FOTOMETRICHE /PHOTOMETRIC DATA

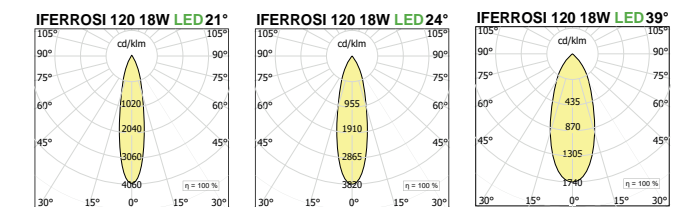
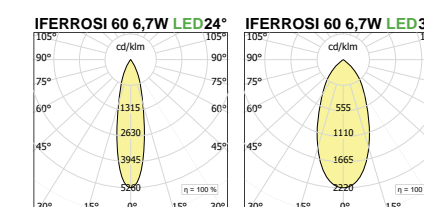





OUTDOOR

IFERROSI FLOOR

DOPPIO PALO

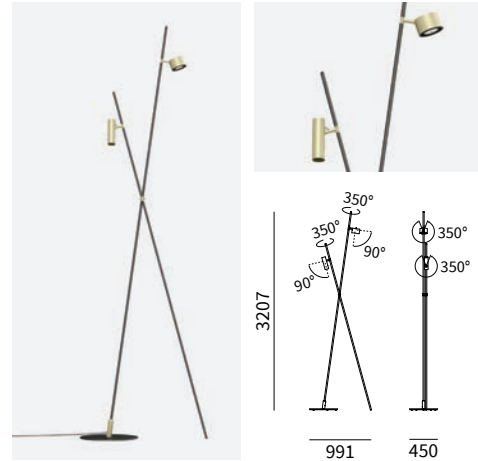

LED W	mA	ø spots	Kg	lm product/beam 3000K F24°	CODE
18	500	120	22	1483	IF01.9 ● F /##
6,7	700	60	22	650	

● disponibile solo fascio F available only F beam
L'apparecchio è dotato di 2 m di cavo | 2 m of cable included.

PALO H3300-120



LED W	mA	ø spot	Kg	lm product/beam 3000K F24°	CODE
18	500	120	16,5	1483	IF02.9 ● F /##

● disponibile solo fascio F available only F beam
L'apparecchio è dotato di 2 m di cavo | 2 m of cable included.

PALO H3300-60

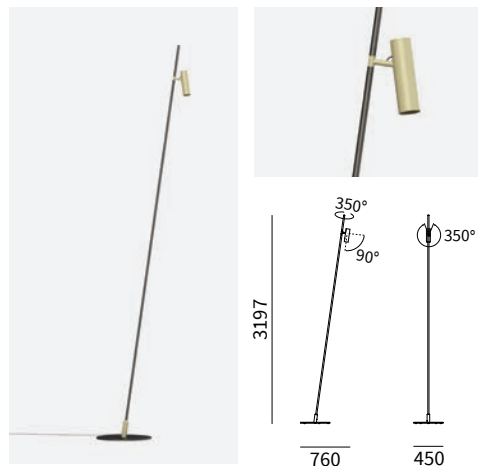

LED W	mA	ø spot	Kg	lm product/beam 3000K W38°	CODE
6,7	700	60	16	712	IF03.9 ● W /##

● disponibile solo fascio W available only W beam
L'apparecchio è dotato di 2 m di cavo | 2 m of cable included.

PALO H3300-60+60

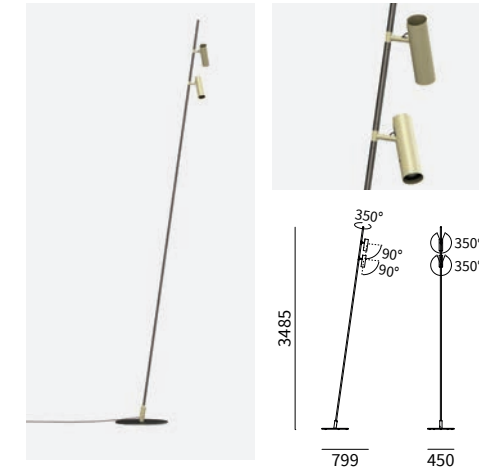

LED W	mA	ø spots	Kg	lm product/beam 3000K F24°	W38°	CODE
1+1x6,7	700	60	20	1300	1424	IF04.9 ● ● /##

● disponibile solo fascio F e W available only F e W beam
L'apparecchio è dotato di 2 m di cavo | 2 m of cable included.

PALO H3300-120



LED W	mA	ø spot	Kg	lm product/beam 3000K W38°	CODE
6,7	700	60	16	712	IF07.9 ● W /##

● disponibile solo fascio W available only W beam

LED W	mA	ø spot	Kg	lm product/beam 3000K F24°	CODE
18	500	120	16,5	1483	IF08.9 ● F /##

● disponibile solo fascio F available only F beam
L'apparecchio è dotato di 2 m di cavo | 2 m of cable included.

ACCESSORI / ACCESSORIES

VANO ALIMENTATORI / POWER SUPPLIERS BOX



CODE
IF76/##

VERSIONI DISPONIBILI / AVAILABLE VERSION

- KELVIN
- 27 2700K
- 30 3000K
- 35 3500K
- 40 4000K

- FASCIO/BEAM
- F Flood
- W Wide

- ## FINITURA/FINISHING
- /46 oro champagne-grafite / champagne gold - graphite
- /99 grafite | graphite

COMPOSIZIONE CODICE: xxx.x ● ● /##

HOW TO CREATE THE CODE: F1000.827S /01

CODE
F1000.8 | ● ● | ## finishing
base code kelvin beam

Per i gradi vedere in tabella - For degrees check the table

500 700 DRIVERS VEDI | SEE P.452

PALO H1300-60

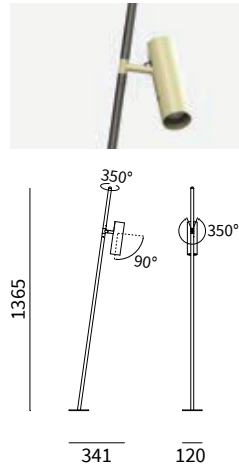
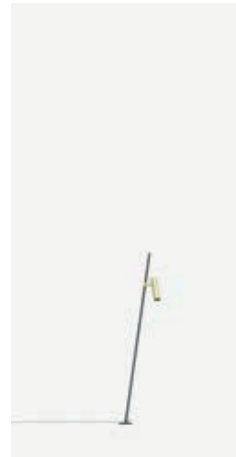

LED W	mA	ø	Kg	Im product/beam 3000K W38°	CODE
6,7	700	60	2,6	712	IF05.9 ● W /##

● disponibile solo fascio **W** available only **W** beam
L'apparecchio è dotato di 2 m di cavo | 2 m of cable included.



PALO H700-36

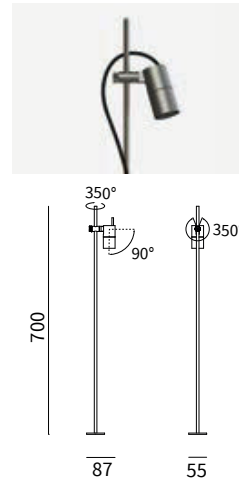
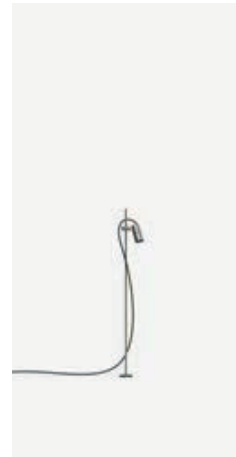

LED W	mA	ø spot	Kg	Im product/beam 3000K S19° F29°	CODE
8	700	36	0,5	665 695	IF06.9 ● ● /62

● disponibile solo fascio **S e F** available only **S e F** beam
Palo tagliabile in altezza. Il proiettore scorre sull'asse del palo. Il cavo è assicurato al palo da o-ring in silicone | The pole can be cut in height. The projector slides on the pole axis. The cable is secured to the pole by silicone gaskets.
L'apparecchio è dotato di 2 m di cavo | 2 m of cable included.



IFERROSI WALL & FLOOR

SPOT120

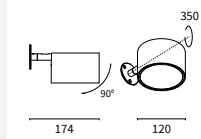

LED W	mA	ø spot	H	Kg	Im product/beam 3000K S21° F24° W39°	CODE
18	500	120	75	1,3	1642 1483 1473	IF20.9 ● ● /##

Cavo in dotazione 1 m | 1 m of cable included

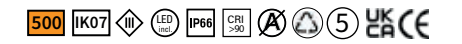

SPOT60

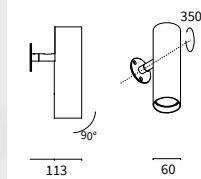

LED W	mA	ø spot	H	Kg	Im product/beam 3000K F24° W38°	CODE
6,7	700	60	200	0,3	650 712	IF21.9 ● ● /##

● disponibile solo fascio **F e W** available only **F e W** beam
Cavo in dotazione 1 m | 1 m of cable included

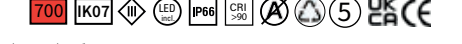

IFERROSI WALL

SPOT120 + CBL

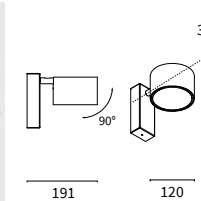

LED W	ø spot	H	Kg	Im product/beam 3000K S21° F24° W39°	CODE
18	120	75	1,7	1642 1483 1473	IF30.9 ● ● /##



SPOT60 + CBL

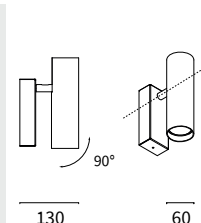

LED W	ø spot	H	Kg	Im product/beam 3000K F24° W38°	CODE
6,7	60	200	0,8	650 712	IF31.9 ● ● /##

● disponibile solo fascio **F e W** available only **F e W** beam



VERSIONI DISPONIBILI/AVAILABLE VERSION

● KELVIN

27	2700K
30	3000K
35	3500K
40	4000K

● FASCIO/BEAM

S	Spot
F	Flood
W	Wide

/## FINITURA/FINISHING

●	/44C oro champagne champagne gold
■	/99 grafite graphite

COMPOSIZIONE CODICE: xxx.x ● ● /##

HOW TO CREATE THE CODE: **F1000.827S/01**
CODE

F1000.8	●	●	—	/## finishing
base code	kelvin	beam		

Per i gradi vedere in tabella -
For degrees check the table

500 700 DRIVERS VEDI | SEE **P.452**

NOTE: MASSIMO N. 3 PROIETTORI PER PALO.

NOTE: MAX 3 PROJECTORS FOR POLE

IF44.250

IF51.9

IF51.9

IF43.250

IF3.250

IF40.800
IF40.2500
IF40.2900
IF41.1200
IF42.700

IF76

IF70

374

I FERROSI

IFERROSI SISTEMA | SYSTEM

PROIETTORI | SPOTS

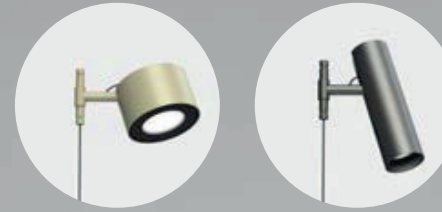

PALI | POLES



BASI ED ACCESSORI | BASES AND ACCESSORIES



OUTDOOR

375

IFERROSI SISTEMA

ELEMENTO SPOT 120 SPOT 120

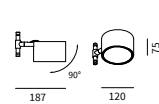

LED	W	mA	ø spot	Kg	Im product/beam 3000K	S21°	F24°	W38°	CODE
	18	500	120	1,3	1642	1483	1473	IF50.9	●●●/##



ELEMENTO SPOT 60 SPOT 60

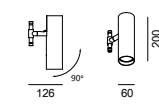

LED	W	mA	ø spot	Kg	Im product/beam 3000K	F24°	W38°	CODE	
	6,7	700	60	0,8	650	712		IF51.9	●●●/##



● disponibile solo fascio F e W available only F e W beam

ELEMENTO SPOT 36 SPOT 36

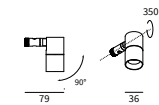

LED	W	mA	ø spot	Kg	Im product/beam 3000K	S19°	F29°	CODE	
	8	700	36	0,3	665	695		IF52.9	●●●/99



● disponibile solo fascio S e F available only S e F beam

Da abbinare a cod. IF42 | To be combined with code IF42

PALI POLES

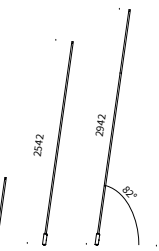

	ø	H	CODE
palo inclinato inclined pole	18	842	IF40.800 /##
palo inclinato inclined pole	18	2542	IF40.2500 /##
palo inclinato inclined pole	18	2942	IF40.2900 /##
palo dritto straight pole	18	2942	IF49.2900 /##



TERMINALE CLOSING MODULE

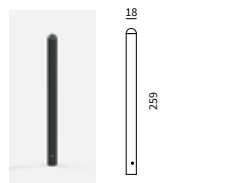

ø	H	CODE
18	250	IF44.250/99

MODULO INTERMEDIO INTERMEDIATE MODULE

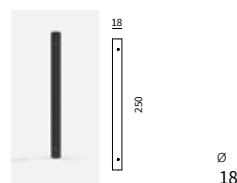

ø	H	CODE
18	250	IF43.250/99

PALO 1200 CON BASE POLE 1200 WITH BASE

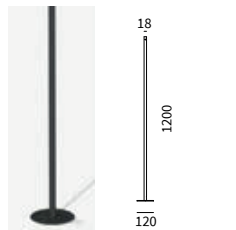

ø base	ø	H	CODE
120	18	1200	IF41.1200 /99

PALO 700 CON BASE POLE 700 WITH BASE

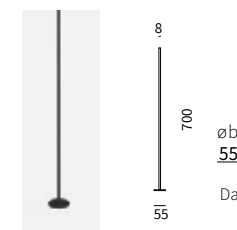

ø base	ø	H	CODE
55	8	700	IF42.700/99

Da abbinare a cod. IF52 | To be combined with code IF52

VERSIONI DISPONIBILI/AVAILABLE VERSION

KELVIN	FASCIO/BEAM	## FINITURA/FINISHING
27 2700K	S Spot	/44C oro champagne champagne gold
30 3000K	F Flood	/99 grafite graphite
35 3500K	W Wide	
40 4000K		

COMPOSIZIONE CODICE: xxx.x ●● /##
 HOW TO CREATE THE CODE: **F1000.827S /01**

CODE

F1000.8 ●● /## finishing

base code kelvin beam

BOX PER ALLOGGIAMENTO ALIMENTATORI BOX PER ALLOGGIAMENTO ALIMENTATORI FLOOR



Kg	CODE
0,20	IF76/99

Da abbinare a cod. IF70 | To be combined with code IF70

BASE DA APPOGGIO BASE FLOOR



ø	Kg	CODE
450	11,4	IF70/99

Da abbinare a cod. IF40 | To be combined with code IF40

FLANGIA DI FISSAGGIO FIXING PLATE



ø	Kg	CODE
120	0,40	IF71/99

Da abbinare a cod. IF40 | To be combined with code IF40

PICCHETTO PER TERRENO GROUND SPIKE



Dim.	Kg	CODE
120X202	0,25	IF73

Da abbinare a cod. IF05-IF40-IF41 (+ IF71) | To be combined with code IF05-IF40-IF41 (+ IF71)

Dim.	Kg	CODE
55X200	0,25	IF74

Da abbinare a cod. IF06-IF42- | To be combined with code IF06-IF42

CAVO DOPPIO ISOLAMENTO IN NEOPRENE 2 X 0,75 DOUBLE COATED NEOPRENE CABLE 2 X 0,75



ø	L mm	CODE
10	5000	IF82.5000
10	10000	IF82.10000

CONNETTORE IP67 CONNECTOR IP67



CODE
IF83

ALIMENTATORE ON/OFF IP20 POWER SUPPLY ON/OFF IP20



per/for spot ø	W	mA	AXB mm	Lmm	CODE
120	1,5÷20	500	38X29	122	AE500.20.C1
60	10	700	37x21	80	AE700.10C
36	36	700	37x21	80	AE700.10C

ALIMENTATORE DALI IP20 POWER SUPPLY DALI IP20



per/for spot ø	W	mA	AXB mm	Lmm	DALI	CODE
120	24	500			x	
60	32	700	67x21	103	x	AE700.32CD.MP
36	32	700			x	

ALIMENTATORE ON/OFF IP67 POWER SUPPLY ON/OFF IP67



per/for spot ø	W	mA	AXB mm	Lmm	CODE
120	22	500	37x24,5	120	AE500.22IP
60-36	19,6	700	38x25	120	AE700.20IP.MP

ALIMENTATORE DALI IP67 POWER SUPPLY DALI IP67



per/for spot ø	W	mA	AXB mm	Lmm	DALI	CODE
120	27,5	500			x	
60	38,5	700	35x33	185	x	AE1000.55D.MP.IP
36	38,5	700			x	

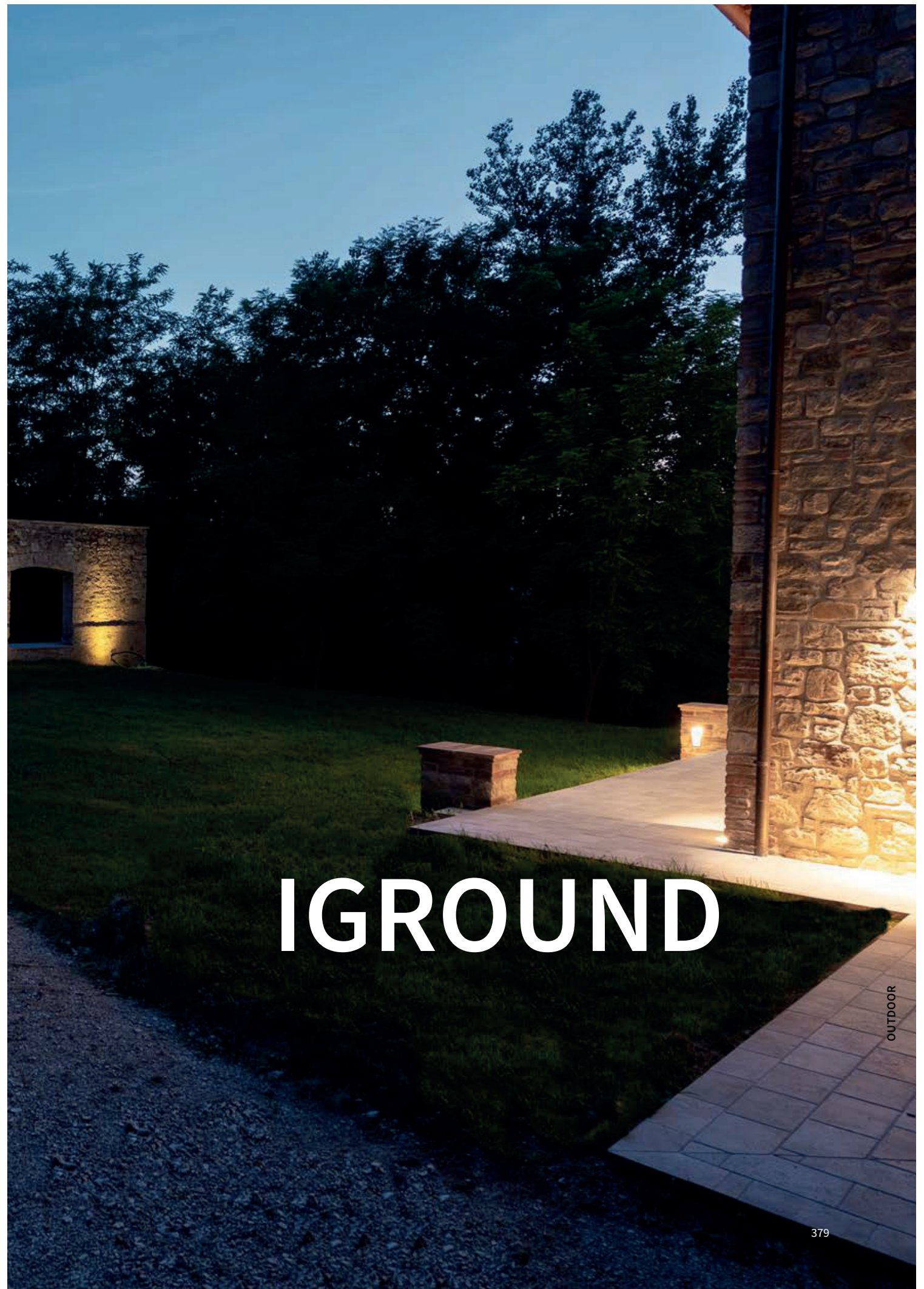

IGROUND

IGROUND

Collezione di apparecchi per esterni da pavimento ad incasso, calpestabili, con sorgenti LED Chip On Board integrate a emissione monocromatica, ottica fissa od orientabile. La basculabilità si ottiene senza dover aprire l'articolo, grazie ad un movimento meccanico situato sul corpo lampada. Il corpo, di forma circolare, è disponibile in tre misure Ø 65 mm, Ø 84 mm, Ø 132 mm e realizzato in alluminio anodizzato, con ghiera in acciaio inox AISI 316L, completo di vetro di protezione temprato extrachiaro, senza viti a vista. Gli apparecchi vengono forniti con 2 metri di cavo in neoprene. Si può richiedere l'aggiunta di 5m, 10m, 15m o 20m di cavo a pagamento. Disponibili controcasse cilindriche per la posa in opera. Il grado di protezione è garantito sull'uscita cavo da pressacavo stagno IP67.

Collection of walk-over recessed floor luminaires with integrated Chip On Board LED sources with monochromatic emission, fixed or adjustable optics. The tilting is obtained without having to open the article, thanks to a mechanical movement located on the lamp body. The body, circular in shape, is available in three sizes Ø 65 mm, Ø 84 mm, Ø 132 mm and made of anodized aluminum, with an AISI 316L stainless steel flange, complete with extra-clear tempered safety glass, without visible screws. The fixtures are supplied with 2 meters of neoprene cable. Additional 5m, 10m, 15m or 20m cable is available upupon request. Cylindrical outer casings available. IP67.



FISSI | FIXED

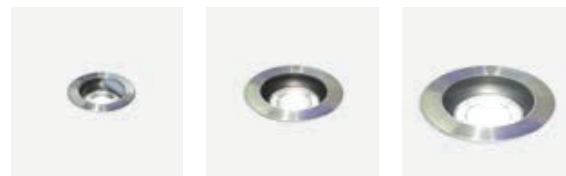

ORIENTABILI | DIRECTIONAL



UK CONFORMITY ASSESSMENT E EUROPEAN CERTIFICATION / UK CONFORMITY ASSESMENT AND EUROPEAN CERTIFICATION



PRODOTTI COSTRUITI CON MATERIALE RICICLABILE / PRODUCTS MADE OF RECYCLABLE MATERIAL



GARANZIA DI 5 ANNI / 5-YEAR WARRANTY

KELVIN		
27		2700°K
30		3000°K
40		4000°K

FASCIO/BEAM

S		SPOT
F		FLOOD
W		WIDE

FINITURE PREMIUM /PREMIUM FINISHINGS

/20		ACCIAIO SATINATO/ BRUSHED STEEL
/27		ALLUMINIO OSSIDATO/ OXISED ALUMINIUM
/49		BRONZO / BRONZE

CURVE FOTOMETRICHE/PHOTOMETRIC DATA

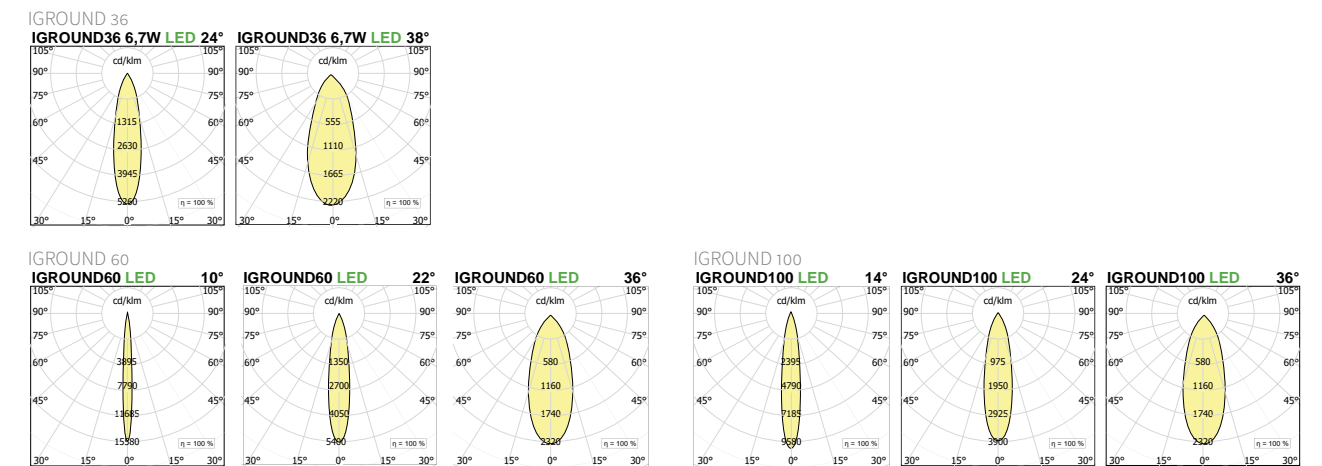

OUTDOOR



VERSIONI DISPONIBILI/AVAILABLE VERSION

● CABLE	● KELVIN	● FASCIO/BEAM	/## FINITURA/FINISHING
A 2 m	27 2700K	S Spot	/20 acciaio satinato brushed steel
B 5 m	30 3000K	F Flood	/27 alluminio anodizzato anodized aluminium
C 10 m	40 4000K	W Wide	/49 bronzo bronze
D 15 m			
E 20 m			

Per i gradi vedere in tabella -
For degrees check the table

COMPOSIZIONE CODICE: xxx.x ● ● /##

HOW TO CREATE THE CODE: IG001A.927F/01

CODE

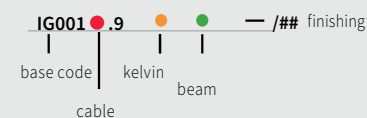

350 500 700 DRIVERS VEDI | SEE P.452

IGROUND FISSO - FIXED

IGROUND 36 FISSO FIXED

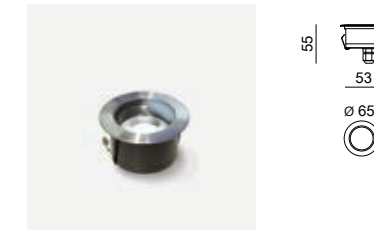

		54 mm		350	IK10	LED	IP67	CR1 >90	5	UK	CE
LED	W	mA	ø	H	Kg	lm product/beam 3000K	CODE				
	3	350	65	55	0,2	F24° W38°	IG001	.9	●	●	/##

● disponibile solo fascio F e W available only F and W beam

Accessori - accessories: **CCIG01** cassaforma - outer casing

IGROUND 60 FISSO FIXED



		73 mm		700	IK10	LED	IP67	CR1 >90	5	UK	CE
LED	W	mA	ø	H	Kg	lm product/beam 3000K	CODE				
	6,7	700	84	65	0,3	S10° F22° W36°	IG002	.9	●	●	/##

Accessori - accessories: **CCIG02** cassaforma - outer casing

IGROUND 100 FISSO FIXED



		108 mm		350	500	IK10	LED	IP67	CR1 >90	5	UK	CE
LED	W	mA	ø	H	Kg	lm product/beam 3000K	CODE					
	12	350	132	85	0,8	S14° F24° W36°	IG003	.9	●	●	/##	
	18	500	132	85	0,8	1785 2298 1702						

Accessori - accessories: **CCIG03** cassaforma - outer casing

IGROUND ORIENTABILE - ADJUSTABLE

IGROUND 60 ORIENTABILE ADJUSTABLE



		73 mm		700	IK10	LED	IP67	CR1 >90	5	UK	CE
LED	W	mA	ø	H	Kg	lm product/beam 3000K	CODE	Col.			
	6,7	700	84	67	0,4	F24° W38°	IG004	.9	●	●	/##

● disponibile solo fascio F e W available only F and W beam

Accessori - accessories: **CCIG02** cassaforma - outer casing
La basculabilità si ottiene senza dover aprire l'articolo, grazie ad un movimento meccanico situato sul corpo lampada. | The tilting is obtained without having to open the article, thanks to a mechanical movement located on the lamp body.

IGROUND 100 ORIENTABILE ADJUSTABLE



		108 mm		350	IK10	LED	IP67	CR1 >90	5	UK	CE
LED	W	mA	ø	H	Kg	lm product/beam 3000K	CODE	Col.			
	12	350	132	95	0,8	S19° F24° W40°	IG005	.9	●	●	/##

Accessori - accessories: **CCIG03** cassaforma - outer casing
La basculabilità si ottiene senza dover aprire l'articolo, grazie ad un movimento meccanico situato sul corpo lampada. | The tilting is obtained without having to open the article, thanks to a mechanical movement located on the lamp body.

CASSAFORMA IN ALLUMINIO ALUMINIUM OUTER CASING

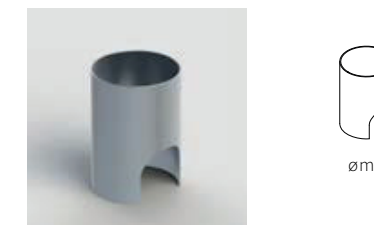

IGROUND 36	ø mm	H mm	CODE
56	80		CCIG01
IGROUND 60	ø mm	H mm	CODE
75	100		CCIG02
IGROUND 100	ø mm	H mm	CODE
110	120		CCIG03



NYX OUTDOOR

NYX OUTDOOR

Apparecchi da incasso a soffitto trimless o con battuta, fissi ed orientabili, per illuminazione d'accento o diffusa. Sorgente luminosa in posizione arretrata anti abbagliamento. Disponibile nelle versioni per installazione in cartongesso o in laterizio e calcestruzzo mediante l'utilizzo di apposite controcasse ordinabili come accessorio. Disponibili con sorgente LED integrata o per lampade GU10 230/240V. Corpo e gruppo ottico in alluminio verniciato. Alimentatore remoto disponibile come accessorio. Grado di protezione IP54

Trimless or trimmed recessed ceiling luminaires, fixed and adjustable, for accent or diffused lighting. Light source in anti-glare recessed position. Available for plasterboard installation or brick and concrete through the use of special outercases to be ordered separately. Powered with integrated LED source or for GU10 230/240V light bulbs. Body and optical group in painted aluminum. Remote power supply available as an accessory. IP54

Q

square and trimless



TF

round, fixed and trimless



FRAME TF

round, fixed with frame



UK CONFORMITY ASSESSMENT E EUROPEAN CERTIFICATION / UK CONFORMITY ASSESSMENT AND EUROPEAN CERTIFICATION



PRODOTTI COSTRUITI CON MATERIALE RICICLABILE / PRODUCTS MADE OF RECYCLABLE MATERIAL



GARANZIA DI 5 ANNI / 5-YEAR WARRANTY



FISSO / FIXED



ORIENTABILE / ADJUSTABLE



DIAMETRI DISPONIBILI DA 40 A 160 MM A SECONDA DEI MODELLI/ AVAILABLE DIAMETERS FROM 40 TO 160 MM IT DEPENDS ON THE MODEL



IDONEI PER CARTONGESSO OR LATERIZIO / CALCESTRUZZO a seconda dei modelli e degli accessori. SUITABLE FOR PLASTERBOARD OR BRICKWALL / CONCRETE it depends on the model and its accessories.



IDONEI PER CAPPOTTI TERMICI CON APPOSITA CASSAFORMA OPZIONALE / SUITABLE FOR THERMAL COATS WITH THE OPTIONAL BOX

KELVIN

27		2700°K
30		3000°K
35		3500°K
40		4000°K

FASCIO/BEAM

S		SPOT
F		FLOOD
W		WIDE

FINITURE STANDARD /STANDARD FINISHINGS

/01		BIANCO/WHITE
/02		NERO/BLACK
/03		CROMO/CHROME
/36		ORO/GOLD
/49		BRONZO/BRONZE

FINITURE PREMIUM /PREMIUM FINISHINGS

/81		ORO ROSA/ROSE GOLD
/82		BRONZO ANTICATO/ ANTIQU BRONZE
/83		OTTONE BRUNITO SPAZZOLATO BRUSHED BURNISHED BRASS

CURVE FOTOMETRICHE/PHOTOMETRIC DATA

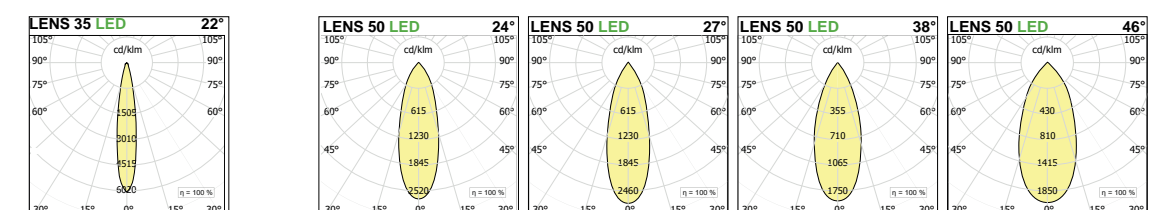

NYX

QUADRATO TRIMLESS

SQUARE TRIMLESS

VERSIONI / VERSIONS



FINITURE / FINISHINGS

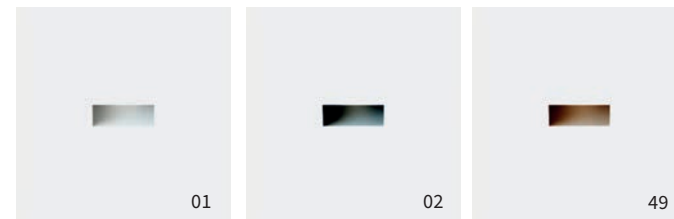

NYX Q35 LED

1 SCEGLIERE CASSA O TELAIO IN BASE AL TIPO DI INSTALLAZIONE / CHOOSE CASE OR FRAME ACCORDING TO THE TYPE OF INSTALLATION

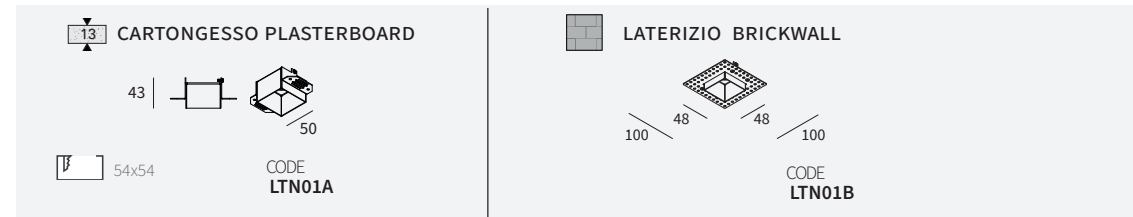

2 SCEGLIERE IL GRUPPO OTTICO / CHOOSE OPTIC GROUP

LED	W	mA	ømm	Hmm	KG	Im prod 3000k /beam	CODE
35°	5	500	40	61	0,11	520	LTN01K.9 ●● / ##

SISTEMA DI INSTALLAZIONE | HOW TO FIXED

CARTONGESSO PLASTERBOARD



NYX Q50 LED



1 SCEGLIERE CASSA O TELAIO IN BASE AL TIPO DI INSTALLAZIONE / CHOOSE CASE OR FRAME ACCORDING TO THE TYPE OF INSTALLATION

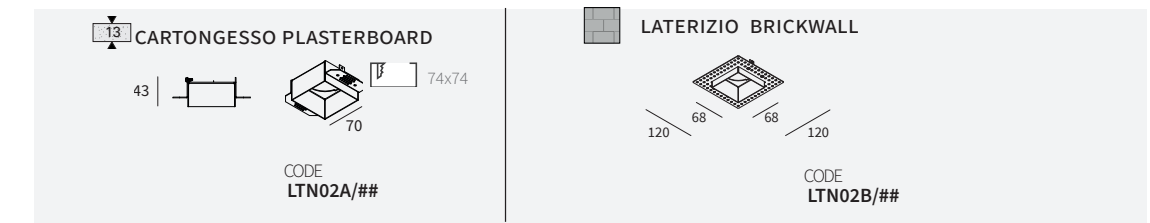

2 SCEGLIERE IL GRUPPO OTTICO / CHOOSE OPTIC GROUP

LED	W	mA	ømm	Hmm	Kg	Im product/beam 3000K	CODE
35°	8	250	60	85	0,19	860	LTN88K.9 ●● / ##
35°	12	350	60	85	0,19	1285	LTN88K.9 ●● / ##
35°	12	350	60	105	0,22	1285	LTN10K.9 ●● / ##
35°	18	500	60	105	0,22	1575	LTN10K.9 ●● / ##

NYX Q50 GU10



1 SCEGLIERE CASSA O TELAIO IN BASE AL TIPO DI INSTALLAZIONE / CHOOSE CASE OR FRAME ACCORDING TO THE TYPE OF INSTALLATION

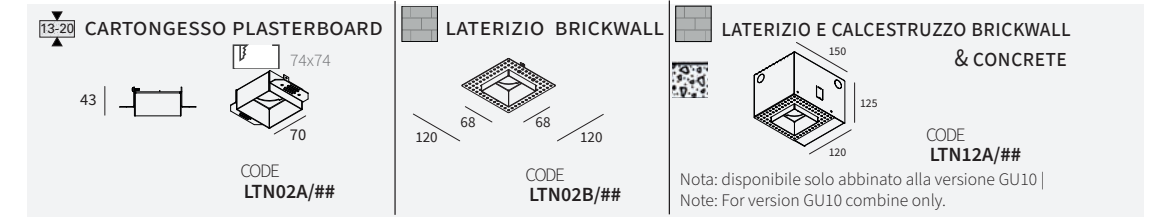

2 SCEGLIERE IL GRUPPO OTTICO / CHOOSE OPTIC GROUP

GU10 LED	W	ømm	Hmm	Kg	CODE
35°	50	60	67	0,09	LTN16K/##

VERSIONI DISPONIBILI/AVAILABLE VERSION

- **KELVIN**
- 27 2700K
- 30 3000K
- 35 3500K
- 40 4000K
- TW Tunable White

● **FASCIO/BEAM**

- F Flood
- W Wide

Per i gradi vedere in tabella - For degrees check the table

/## **FINITURA/FINISHING**

- /01 bianco | white
- /02 nero | black
- /49 bronzo/bronze

/## **FINITURA PREMIUM /PREMIUM FINISHING**

- /81 oro rosa/rose gold
- /82 bronzo anticato/antique bronze
- /83 ottone brunito spazzolato|brushed burnished brass

COMPOSIZIONE CODICE: xxx.x●●/##

HOW TO CREATE THE CODE: F1000.827S/01

CODE
F1000.8 ●● /## — finishing
base code kelvin beam

OUTDOOR

NYX T35F

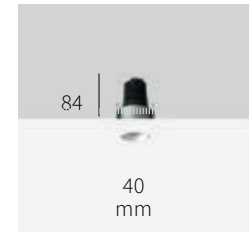

1 SCEGLIERE CASSA O TELAIO IN BASE AL TIPO DI INSTALLAZIONE / CHOOSE CASE OR FRAME ACCORDING TO THE TYPE OF INSTALLATION

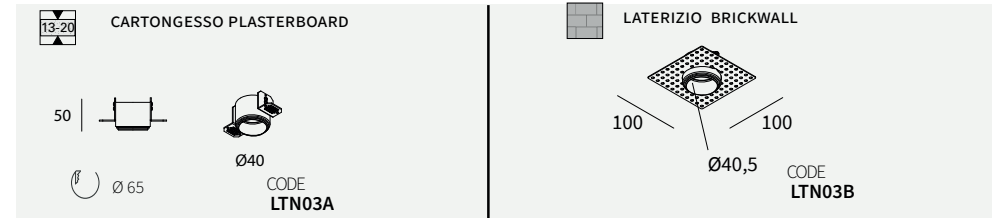

2 SCEGLIERE IL GRUPPO OTTICO / CHOOSE OPTIC GROUP

LED		W		mA		ømm		Hmm		Kg		lm prod/beam 3000k		F21°		CODE	
84	Ø40	5	500	40	84	0,11	520									LTN30K.9 ●● / ##	

● Disponibile solo fascio F | Available only F beam

NYX T50F



1 SCEGLIERE CASSA O TELAIO IN BASE AL TIPO DI INSTALLAZIONE / CHOOSE CASE OR FRAME ACCORDING TO THE TYPE OF INSTALLATION

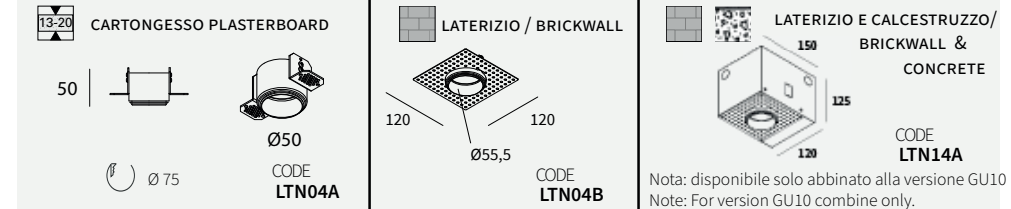

2 SCEGLIERE IL GRUPPO OTTICO / CHOOSE OPTIC GROUP

LED		W		mA		ømm		Hmm		Kg		lm prod/beam 3000K		F27°		W46°		CODE	
107	Ø55	8	250	55	107	0,28	860	860									LTN89K.9 ●● / ##		
127	Ø55	12	350	55	127	0,30	1285	1285									LTN50K.9 ●● / ##		

GU10		N		ømm		Hmm		Kg		CODE	
94	Ø55	50	55	94	0,21					LTN56K/##	

Accessori - accessories: L050#: lente Ø 50
Nota: Alla versione GU10 è possibile abbinare soltanto la lente L###R nido d'ape | Note: For version GU10 combine L###R honey comb only.

NYX T80F



1 SCEGLIERE CASSA O TELAIO IN BASE AL TIPO DI INSTALLAZIONE / CHOOSE CASE OR FRAME ACCORDING TO THE TYPE OF INSTALLATION

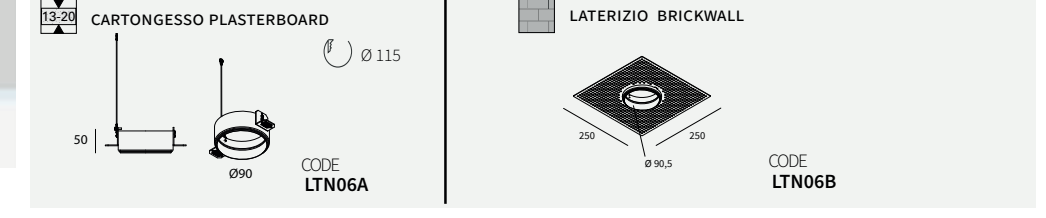

2 SCEGLIERE IL GRUPPO OTTICO / CHOOSE OPTIC GROUP

LED		W		mA		ø		H		Kg		lm product/beam 3000K			CODE	
136	Ø90	17	500	90	136	0,80	1930	1827	1905						LTN20K.9 ●● / ##	
		24,3	700	90	136	0,80	2468	2356	2430							

Accessori - accessories: L074#: lente Ø 74 - satin Ø 74 Gli apparecchi con temperatura colore Tunable White devono essere associati a driver a 2 canali. | The devices with Tunable white color temperature have to be supplied with 2 channel driver.

NYX T111F



1 SCEGLIERE CASSA O TELAIO IN BASE AL TIPO DI INSTALLAZIONE / CHOOSE CASE OR FRAME ACCORDING TO THE TYPE OF INSTALLATION

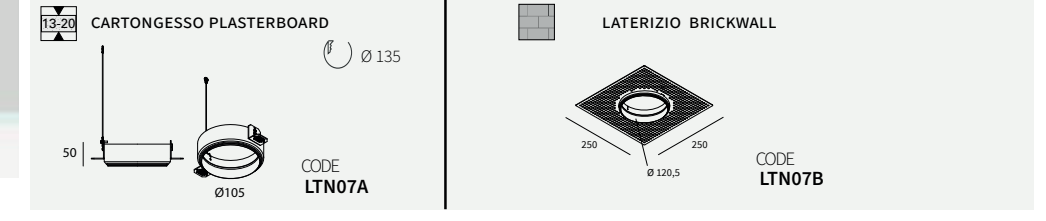

2 SCEGLIERE IL GRUPPO OTTICO / CHOOSE OPTIC GROUP

LED		W		mA		ø		H		Kg		lm product/beam 3000K			CODE	
168	Ø120	24,3	700	120	168	1,43	2468	2356	2430						LTN70K.9 ●● / ##	
		32	900	120	168	1,43	3006	2885	2955							

Accessori - accessories: L111#: lente Ø 111 - lens Ø 111

ACCESSORI / ACCESSORIES

LENTI NYX Q50 / LENSES NYX Q50			LENTI NYX Q80 / LENSES NYX Q80			LENTI NYX Q111 / LENSES NYX Q120		
●	LENTE SATINATA / SATINED LENS	50 0,01 L050S/##	●	LENTE ELISSOIDALE / ELIPSOID LENS	74 0,01 L080S/##	●	LENTE ELISSOIDALE / ELIPSOID LENS	111 0,01 L0111S/##
●	LENTE ELISSOIDALE / ELIPSOID LENS	50 0,01 L050E/##	●	LENTE ASIMMETRICA / ASYMMETRIC LENS	74 0,01 L080E/##	●	LENTE ASIMMETRICA / ASYMMETRIC LENS	111 0,01 L0111E/##
●	LENTE ASIMMETRICA / ASYMMETRIC LENS	50 0,01 L050A/##	●	FILTRO NIDO D'APE / HONEY COMB LOUVER	74 0,01 L080A/##	●	FILTRO NIDO D'APE / HONEY COMB LOUVER	111 0,01 L0111A/##
●	FILTRO NIDO D'APE / HONEY COMB LOUVER	50 0,01 L050R/##	●		74 0,01 L080R/##	●		111 0,01 L0111R/##

VERSIONI DISPONIBILI / AVAILABLE VERSION

- KELVIN
- 27 2700K
- 30 3000K
- 35 3500K
- 40 4000K
- FASCIO / BEAM
- S Spot
- F Flood
- W Wide

/## FINITURA / FINISHING

- /01 bianco | white
- /02 nero | black
- /49 bronzo / bronze
- /## FINITURA PREMIUM / PREMIUM FINISHING
- /81 oro rosa / rose gold
- /82 bronzo anticato / antique bronze
- /83 ottone brunito spazzolato / brushed burnished brass

COMPOSIZIONE CODICE: xxx.x ●● /

HOW TO CREATE THE CODE: F1000.827S/01

CODE

F1000.8 | ●● | /## | — finishing

base code kelvin beam

250 350 500 700 900

DRIVERS VEDI | SEE P.452

Per i gradi vedere in tabella - For degrees check the table



VERSIONI / VERSIONS



FINITURE / FINISHINGS



VERSIONI DISPONIBILI/AVAILABLE VERSION

- | | |
|-----------------|-----------------|
| ● KELVIN | ○ KELVIN |
| 27 2700K | 27 2700K |
| 30 3000K | 30 3000K |
| 35 3500K | 35 3500K |
| 40 4000K | 40 4000K |

- TW Tunable White Dali
● **FASCIO/BEAM**

- **S** Spot
● **F** Flood
● **W** Wide

Per i gradi vedere in tabella - For degrees check the table

FINITURA/FINISHING

/01 bianco | white

/02 nero | black

/36 oro/gold

/49 bronzo/bronze

FINITURA PREMIUM /PREMIUM FINISHING

/81 oro rosa/rose gold

/82 bronzo anticato/antique bronze

/83 ottone brunito spazzolato|brushed burnished brass

COMPOSIZIONE CODICE: xxx.x ●●/##

HOW TO CREATE THE CODE: **F1000.827S/01**

CODE

F1000.8 ●● /## finishing

base code kelvin beam

250 350 500 700 900

DRIVERS VEDI | SEE P.452

NYX TF35F

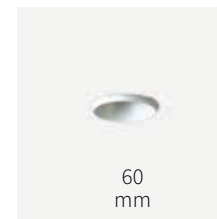

CARTONGESSO PLASTERBOARD 8-15

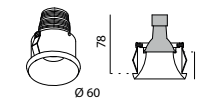

LED								Im product/beam 3000K		500
W	mA	ø	H	Kg	F28°			CODE		
5	500	60	78	0,18	465			NF010.9	F / ##	

● Disponibile solo fascio F | Available only F beam

NYX TF50F



CARTONGESSO PLASTERBOARD 8-15

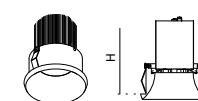

LED								Im product/beam 3000K		250	350
W	mA	ø	H	Kg	F27°	W46°			CODE		
8	250	75	102	0,25	860	860			NF024.9	●● / ##	
12	350	75	102	0,25	1285	1285					
LED								Im product/beam 3000K		350	500
W	mA	ø	H	Kg	F27°	W46°			CODE		
12	350	75	122	0,25	1285	1289			NF023.9	●● / ##	
18	500	75	122	0,25	1575	1579					

GU10 LED							IP20 IP54		5 UK CE	
W	ø	H	Kg	CODE						
1 x max50	75	86	0,25	NF028/##						

Accessori - accessories: L050#: lente Ø 50 - lens Ø 50

Gli apparecchi con temperatura colore Tunable White devono essere associati a driver a 2 canali. | The devices with Tunable white color temperature have to be supplied with 2 channel driver.

NYX TF80F



CARTONGESSO PLASTERBOARD 8-30

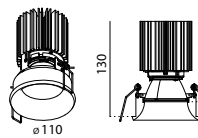

LED								Im product/beam 3000K		500	700
W	mA	ø	H	Kg	S15°	F24°	W38°			CODE	
17	500	110	130	0,85	1930	1827	1905			NF040.9	●● / ##
24,3	700	110	130	0,85	2468	2356	2430				

Accessori - accessories: L074#: lente Ø 74 - lens Ø 74

Gli apparecchi con temperatura colore Tunable White devono essere associati a driver a 2 canali. | The devices with Tunable white color temperature have to be supplied with 2 channel driver.

NYX TF111F



CARTONGESSO PLASTERBOARD 8-30

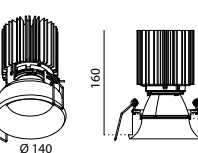

LED								Im product/beam 3000K		700	900
W	mA	ø	H	Kg	S16°	F25°	W40°			CODE	
24,3	700	140	160	1,4	2468	2356	2430			NF060.9	●● / ##
32	900	140	160	1,4	3006	2885	2955				

Accessori - accessories: L111#: lente Ø 111 - lens Ø 111

ACCESSORI / ACCESSORIES

LENTI NYX Q50 / LENSES NYX Q50

●	ø	Kg	CODE
●	50	0,01	L050S/ ##
●	50	0,01	L050E/ ##
●	50	0,01	L050A/ ##
●	50	0,01	L050R/ ##

LENTI NYX Q80 / LENSES NYX Q80

ø	Kg	CODE
74	0,01	L080S/ ##
74	0,01	L080E/ ##
74	0,01	L080A/ ##
74	0,01	L080R/ ##

LENTI NYX Q111 / LENSES NYX Q120

ø	Kg	CODE
111	0,01	L0111S/ ##
111	0,01	L0111E/ ##
111	0,01	L0111A/ ##
111	0,01	L0111R/ ##

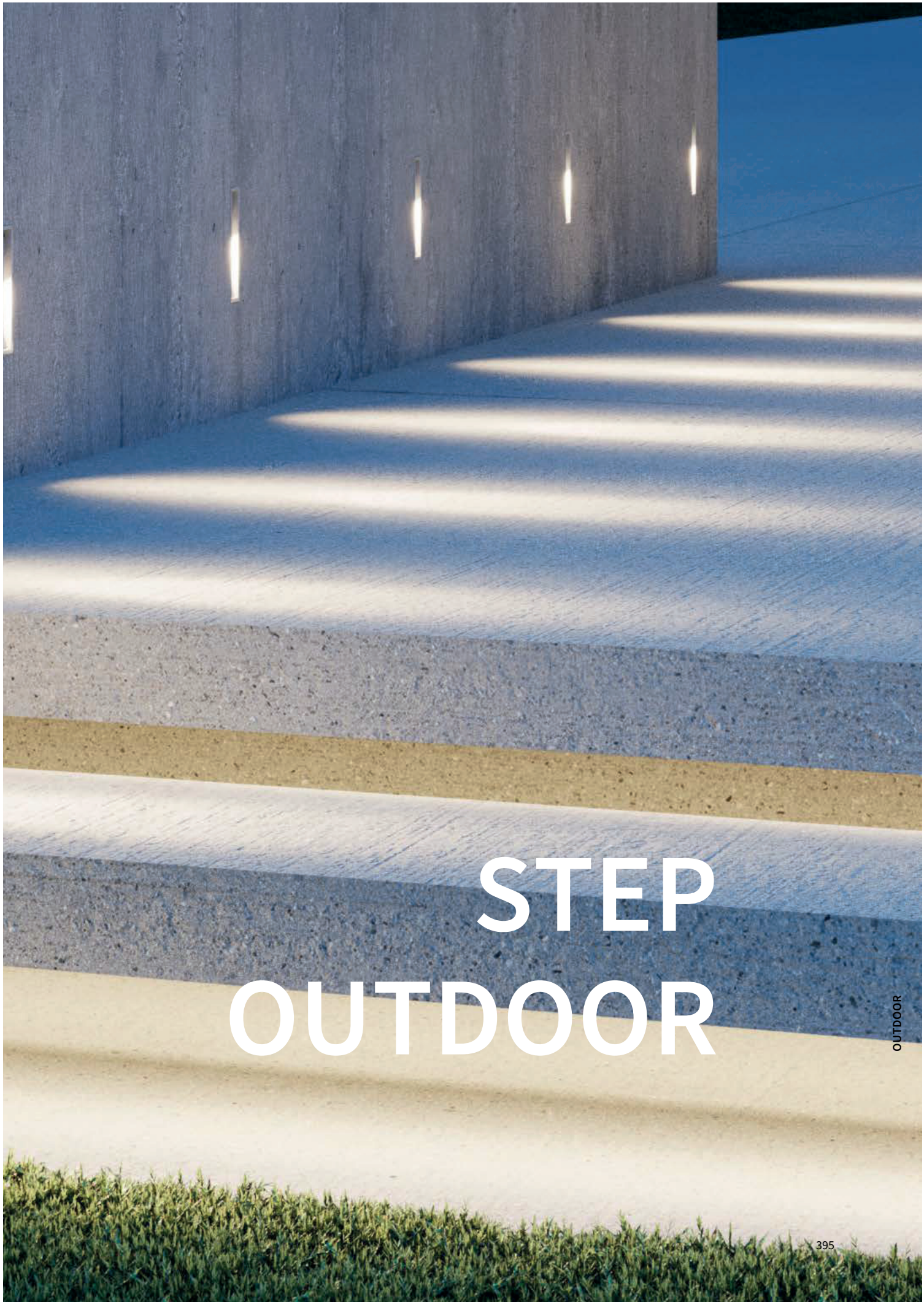
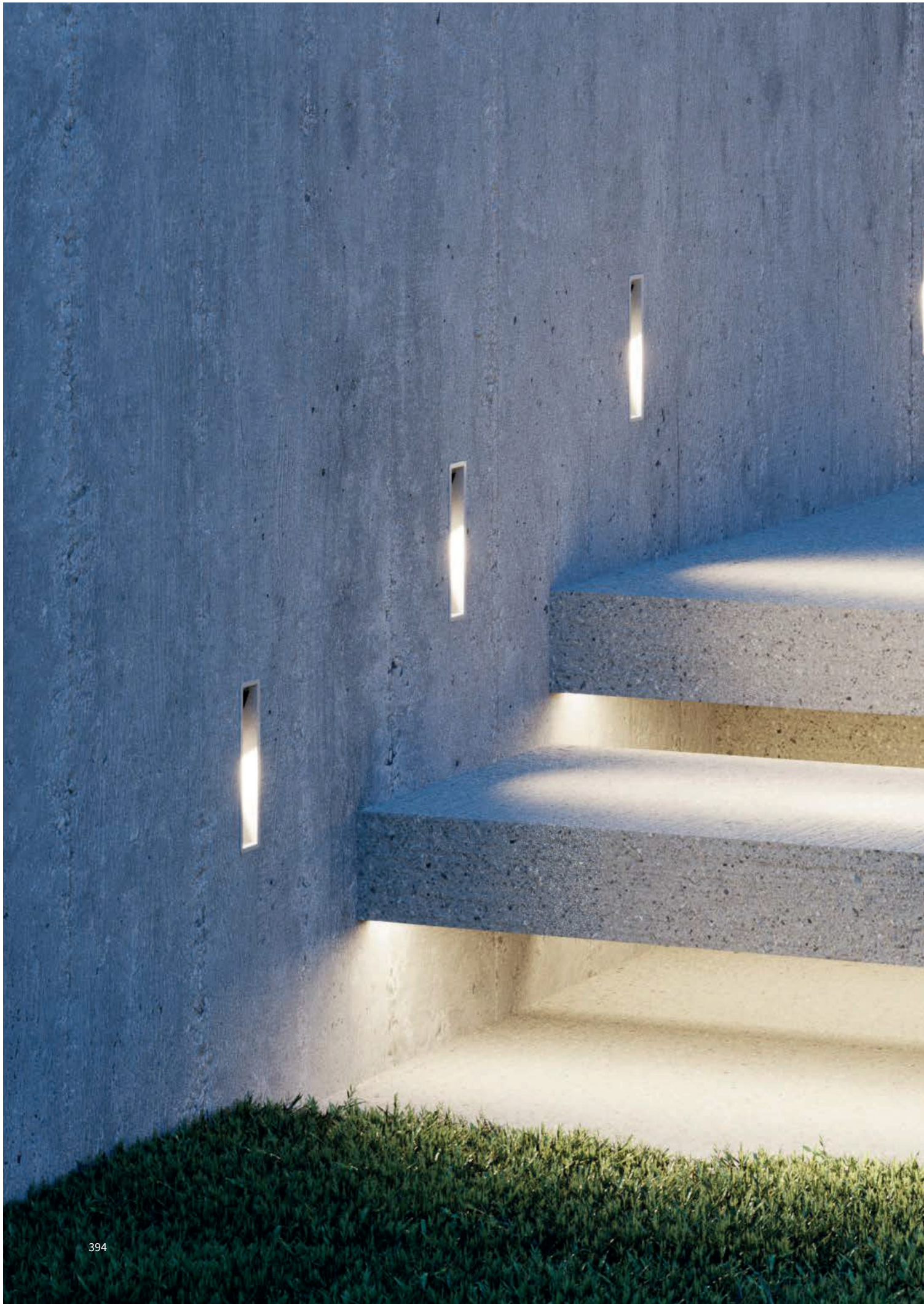

STEP OUTDOOR

STEP OUTDOOR

Apparecchio da incasso a parete per illuminazione segnapasso direzionata con angolo di 20°, per sorgente LED integrata con alimentazione remota disponibile come accessorio. Corpo e cornice di battuta super-slim larghezza 5 mm. in metallo verniciato. Installabile anche in pareti e soffitti in calcestruzzo mediante apposita cassaforma in lamiera zincata disponibile come accessorio. Grado di protezione IP65.

Recessed downlight for wall installation, for guidance lighting with 20° angle direction, for integrated LED source with remote power-supply available as an accessory. Body and super-slim 5 mm width frame in painted metal. It can also be installed in concrete or brick walls through specific galvanized steel wall-box, available as an accessory. Degree of protection IP65.



UK CONFORMITY ASSESSMENT E EUROPEAN CERTIFICATION / UK CONFORMITY ASSESSMENT AND EUROPEAN CERTIFICATION



PRODOTTI COSTRUITI CON MATERIALE RICICLABILE / PRODUCTS MADE OF RECYCLABLE MATERIAL



GARANZIA DI 5 ANNI / 5-YEAR WARRANTY

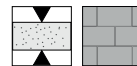

IDONEI PER CARTONGESSO O LATERIZIO / CALCESTRUZZO CON APPOSITA CASSAFORMA OPZIONALE / SUITABLE FOR PLASTERBOARD OR BRICKWALL / CONCRETE WITH THE OPTIONAL BOX



IDONEI PER CAPPOTTI CON APPOSITA CASSAFORMA OPZIONALE / SUITABLE FOR COATS WITH THE OPTIONAL BOX

FINITURE STANDARD / STANDARD FINISHINGS

- /01 BIANCO/WHITE
- /02 NERO/BLACK
- /60 CORTEN / CORTEN

PHOTOMETRIC DATA

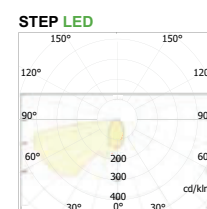

COMPOSIZIONE CODICE: xxx/##

HOW TO CREATE THE CODE:

CODE
F1000.8 / ##
 |
 base code

/## FINITURA/FINISHING

- /01 bianco | white
- /02 nero | black
- /60 corten | corten

500

DRIVERS VEDI | SEE P.452

STEP 75

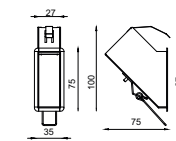
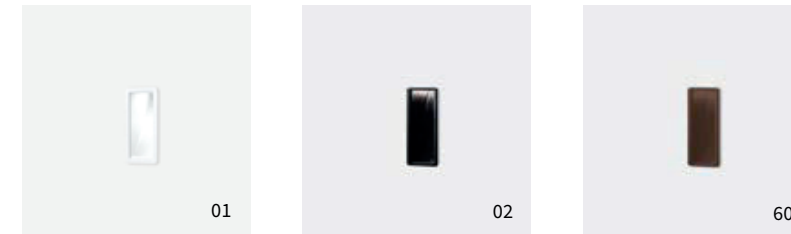

LED		Dim.		H	Kg	lm product/beam 3000K	CODE
W	mA	27x75	67	16°	0,2	252	LT1983BCIP/##

Accessori - accessories: LT1992: cassaforma step 75 - Wallbox step 75

STEP 150

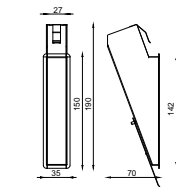

LED		Dim.		H	Kg	lm product/beam 3000K	CODE
W	mA	27x70	142	16°	0,4	252	LT1982BCIP/##

Accessori - accessories: LT1991: cassaforma step 150 - Wallbox step 150

STEP 300

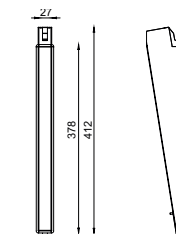

LED		Dim.		H	Kg	lm product/beam 3000K	CODE
W	mA	27x70	370	16°	0,7	252	LT1981BCIP/##

Accessori - accessories: LT1990: cassaforma step 300 - Wallbox step 300

ACCESSORI / ACCESSORIES

CASSAFORMA ADATTA ANCHE A I CAPPOTTI | WALLBOX SUITABLE FOR INSULATING COATS

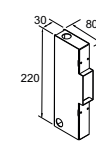

Dim.	H	CODE
STEP75 30x80	220	LT1992

Idonea anche per calcestruzzo. Suitable also for brickwall.

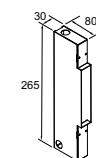

Dim.	H	CODE
STEP150 30x80	265	LT1991

Idonea anche per calcestruzzo. Suitable also for brickwall.

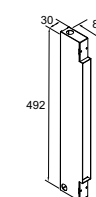

Dim.	H	CODE
STEP300 30x80	492	LT1990

Idonea anche per calcestruzzo. Suitable also for brickwall.

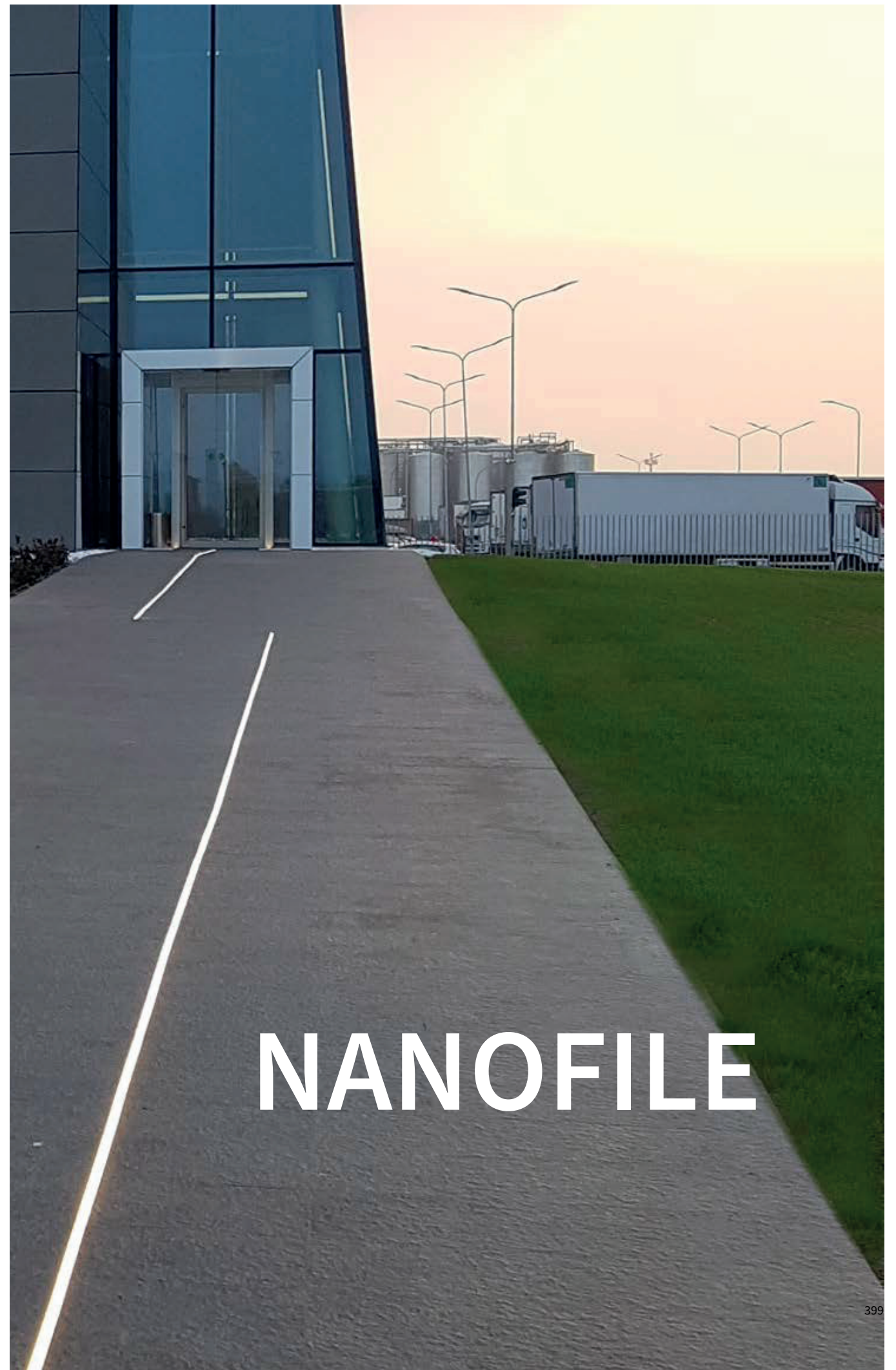

NANOFILE

NANOFILE

Sistema modulare per illuminazione da esterno diffusa, composto da profili vuoti in estruso di alluminio anodizzato disponibili in lunghezze predefinite, disponibili nella versione incasso trimless. Testate di chiusura laterali con sistema Light Proof. Da completare con elemento luminoso in silicone completo di sorgenti lineari LED e con alimentatore 24V da installarsi remoto. Grado di protezione IP67.

Modular system for diffused outdoor lighting, composed of empty profiles in anodized extruded aluminum available in predefined lengths, trimless recessed version. Side end caps with Light Proof system. To be completed with silicone light element complete with LED linear sources and with 24V power supply to be installed remotely. IP67.



UK CONFORMITY ASSESSMENT E EUROPEAN CERTIFICATION / UK CONFORMITY ASSESMENT AND EUROPEAN CERTIFICATION



PRODOTTI COSTRUITI CON MATERIALE RICICLABILE / PRODUCTS MADE OF RECYCLABLE MATERIAL



GARANZIA DI 5 ANNI / 5-YEAR WARRANTY

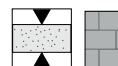

IDONEI PER CARTONGESSO O LATERIZIO / CALCESTRUZZO CON APPOSITA CASSAFORMA OPZIONALE
SUITABLE FOR PLASTERBOARD OR BRICKWALL / CONCRETE WITH THE OPTIONAL BOX

FINITURE/FINISHINGS



/27 ALLUMINIO ANODIZZATO/
ANODIZED ALUMINIUM

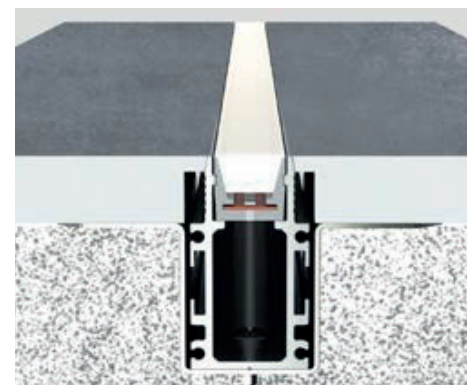
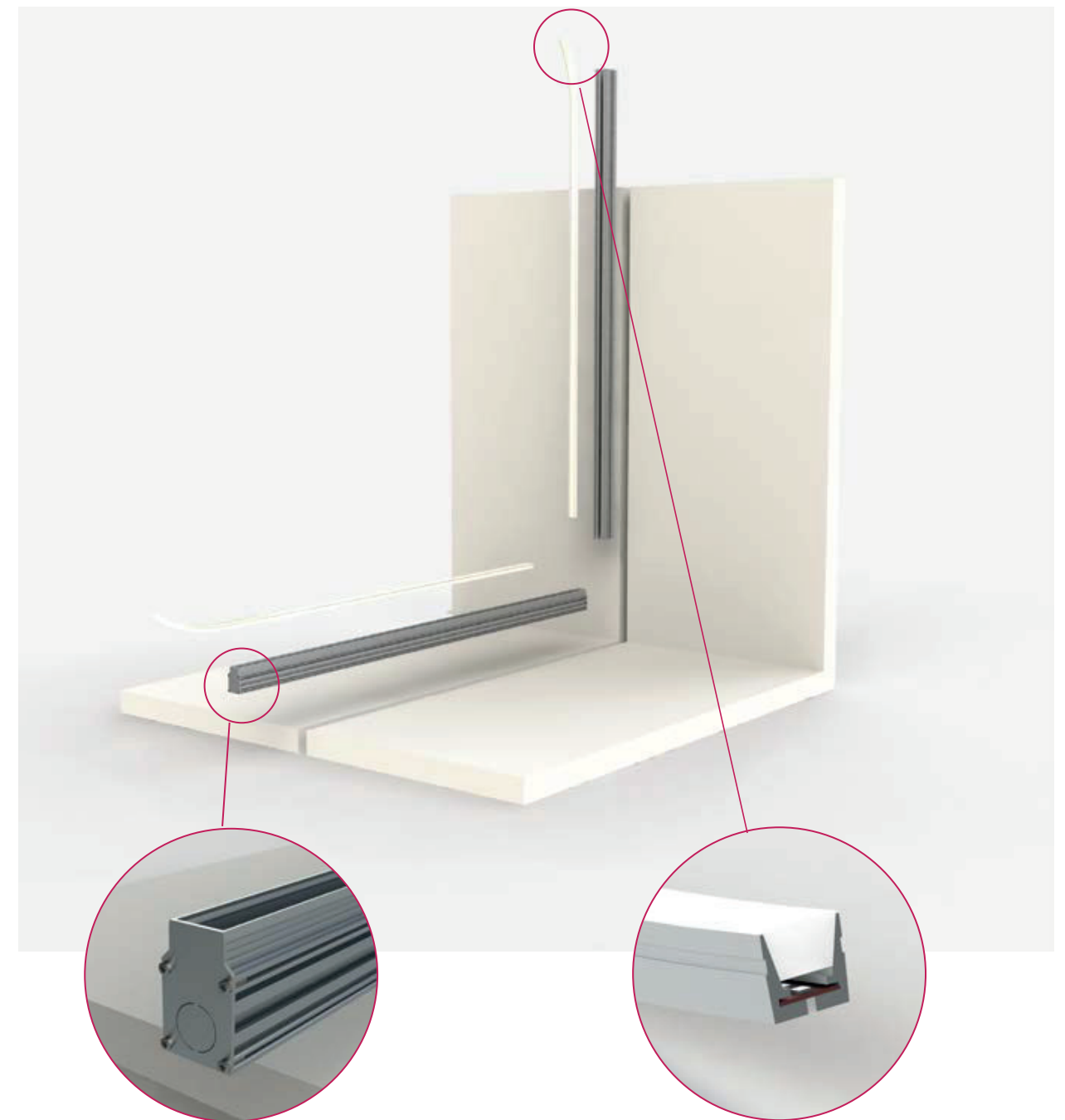

INSTALLAZIONE A TERRA
INSTALLATION ON THE FLOOR

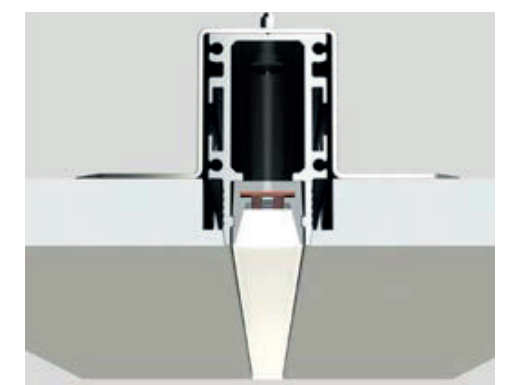

INSTALLAZIONE IN CARTONGESSO
INSTALLATION IN PLASTERBOARD

OUTDOOR



PROFILO VUOTO PER LATERIZIO, CARTONGESSO E CALCESTRUZZO EMPTY PROFILE FOR BRICK WALL, PLASTERBOARD AND CONCRETE

12,5 L+5x24 mm

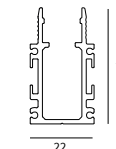
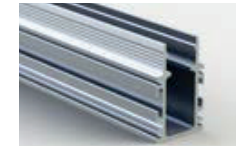

Dim.	H	CODE	Col.
505x22	40	NN01.505	
1005x22	40	NN01.1005	
2005x22	40	NN01.2005	/27
3005x22	40	NN01.3005	
-----x22	40	NN01.misura + 5mm	

STAFFA DI FISSAGGIO PER CARTONGESSO FIXING BRACKET FOR PLASTERBOARD

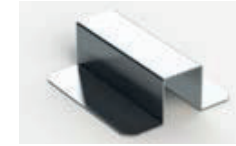

CODE **NN02** Col. /27

Minimo 2 pezzi, 1 ogni metro | minimum 2 pieces 1 every meter

COPPIA TESTATE COUPLE CLOSURE HEAD



CODE **NN03** Col. /27

COPPIA GIUNTI LINEARI LINEAR JOINTS COUPLE



CODE **NN04**

ELEMENTO LUMINOSO IN SILICONE, LINEA LED INTERNA

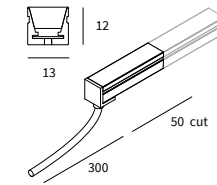
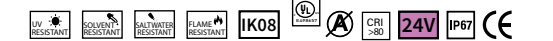

W/mt	W/tot	V	cut	Lmm	lm product/3000K	CODE
9,6	48	24	50mm	5000	3200	NN05.8
9,6	24	50mm	misura	-----	-----	NN058 .misura

● **KELVIN**
27 2700K
30 3000K
40 4000K

KIT CAPS KIT CAPS



CODE **NN08**

COUPLE OF END CAPS

Da utilizzare nel caso in cui sia necessario tagliare l'elemento luminoso - To use if necessary to cut the lighting module.

CONNETTORE IP68 DA POSIZIONARE NEL POZZETTO CONNECTOR IP68 TO BE POSITIONED IN THE ELECTRIC WELL



CODE **NN09**

nota: per linea - note: 1 each line

ALIMENTATORI POWER SUPPLY

I	V IN	V OUT RANGE	W	AXB mm	L mm	FORO Ø mm	IP	24V
max 0,8 A	220÷240V	24	25	38X29	131	48	67	AE25.24VIP
max 2,5 A	220÷240V	24	60	44X40	198	70	67	AE60.24VIP
max 4 A	220÷240V	24	100	70X35	201	79	67	AE100.2.24VIP
max 6 A	120÷240V	24	150	69X37	210	78	67	AE150.24VIP
max 6 A	220÷240V	24	150	63X35	220	73	67	AE150D.24VIP



PIAZZA DELLA CONCORDIA - LAPEDONA (FM)
PROJECT: ARCH. STORTONI, ARCH. MARANI, ARCH. CICCOTOSTO,
ARCH. VALARDINELLI, ARCH. CARDINALI
PH: CICCOTOSTO VALENTINA



ICEMENTI

OUTDOOR

ICEMENTI

Collezione di apparecchi per esterni da pavimento e parete per illuminazione diffusa o di orientamento e guida. Completi di sorgenti LED chip on board e alimentazione elettronica integrata 50/60Hz. Gruppo ottico in alluminio con emissione monolaterale, monoemissione o biemissione protetto con vetro temperato extrachiaro alleggerito. Completi di piastra di montaggio in acciaio per il fissaggio a parete o terra. Corpo in VFRC (vinilic fiber reinforced concrete) cemento fibrato Grado di protezione IP65

Collection of outdoor floor and wall luminaires for diffused or orientation and guide lighting. Complete with chip on board LED sources and integrated 50/60Hz electronic power supply. Optical unit in aluminum with single-sided emission, single-emission or double-emission protected with extra-clear tempered glass. Complete with steel mounting plate for wall or ground fixing. Body in VFRC (vinyl fiber reinforced concrete) fiber cement IP65.



UK CONFORMITY ASSESSMENT E EUROPEAN CERTIFICATION / UK CONFORMITY ASSESSTMENT AND EUROPEAN CERTIFICATION



PRODOTTI COSTRUITI CON MATERIALE RICICLABILE / PRODUCTS MADE OF RECYCLABLE MATERIAL



GARANZIA DI 5 ANNI / 5-YEAR WARRANTY

KELVIN



27 - 2700°K



30 - 3000°K



40 - 4000°K

CURVE FOTOMETRICHE/PHOTOMETRIC DATA

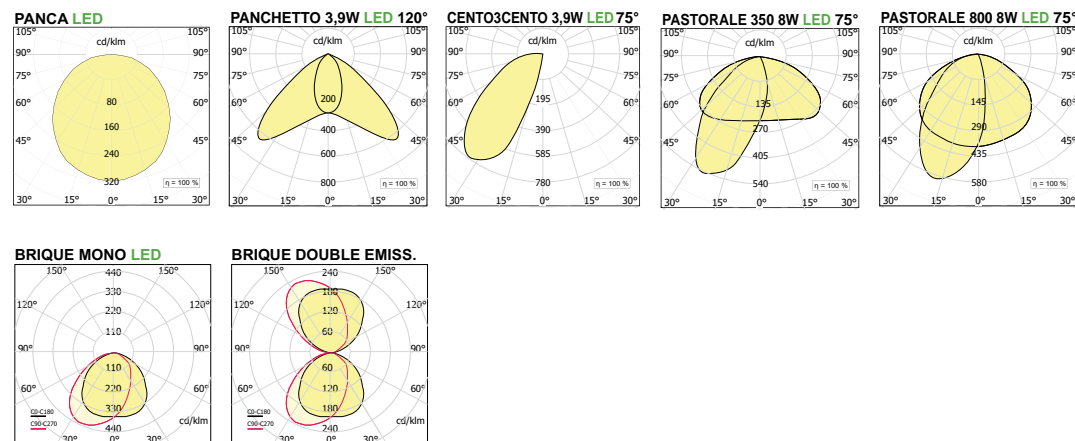

THE OUTDOOR COLLECTION



PANCA



PASTORALE



CENTO3CENTO



BRIQUE



THE INDOOR COLLECTION vedi capitolo | see chapter
“Wall/Celing/Suspension/Floor” P.217



051



2BO2



2BO1



BRIQUE



OUTDOOR

Materiale Corpo in Cementolight® un cemento leggero, ottenuto con un impasto di inerti selezionati e cariche alleggerenti, a cui si aggiungono additivi per migliorare le caratteristiche meccaniche, un materiale che nasce per realizzare elementi architettonici non strutturali dal peso estremamente ridotto, fino ad un terzo del cemento tradizionale. **Material** Made from an innovative material, **Cementolight®**, lightweight fiber concrete, which combines aesthetic appearance, tactile sensation, strength and resistance to weathering of the concrete with productive lightness and malleability, makes forms not initially feasible now possible, iCementi are offered as a range of innovative and functional indoor and outdoor lighting appliances.

Aspetto e sensazione tattile Esteriormente iCementi si presentano pressoché identici ad oggetti realizzati in cemento pieno, sia nell'aspetto - anche per le irregolarità nella tonalità, che cambia con l'alternarsi delle stagioni per il diverso tasso di umidità presente nell'aria - sia al tatto, cui la superficie si presenta liscia ma materica. **Appearance and tactile sensation** Exteriorly iCementi are almost identical to objects made of solid concrete, both in terms of appearance - also due to the irregularities in the tonality, which changes with the seasons due to the different rate of humidity in the air - and to the touch, to which the surface is smooth yet material.

Leggerezza Cementolight® permette la posa dei manufatti in modo semplice e agevole rispetto al cemento tradizionale: non richiede demolizione e riduce di molto il carico strutturale sugli edifici. **Lightness** iCementi weigh up to 70% less than similar forms made of traditional cement. CementoPiuma from which they are made, confers them exceptional manoeuvrability together with ease of transportation and installation that is unparalleled.

Robustezza e resistenza agli agenti atmosferici È un agglomerato adatto sia ad applicazioni indoor che outdoor, è idrorepellente e può essere colorato in massa. Il formulato è Cementolight® 1000, adatto a manufatti con dimensioni contenute e dettagli molto fini. Grado di protezione IP65. **Strength and resistance to weathering** CementoPiuma provides iCementi with a degree of strength and resistance both to knocks and weathering equal to that of solid cement. The surface is not hydrophobic but the external layer's blend of concrete with high silicon rate sand makes iCementi less prone than traditional concrete to the absorption of water.

Facilità di installazione I prodotti della collezione sono forniti già internamente cablati per l'installazione, come qualsiasi altro apparecchio di illuminazione, aspetto questo di particolare importanza nel caso di prodotti di una certa dimensione, perché ne semplifica l'installazione elettrica. **Ease of installation** The products of the collection are supplied already internally wired for installation, as any other lighting appliance, an aspect of particular importance in the case of products of a certain size, because it simplifies their electrical installation.

Tecnologia LED Completi di sorgenti LED chip on board e alimentazione elettronica integrata 50/60Hz. Versioni da terra fornite di gruppo ottico in alluminio con emissione mono o bilaterale e piastra di montaggio in acciaio per il fissaggio a terra con blocco antifurto. **LED technology** In line with the times, the entire collection is designed to accommodate latest generation LED sources and, in the case of larger size appliances, also fluorescent, to ensure maximum energy savings, a minimisation of maintenance and respect for the environment.

VERSIONI DISPONIBILI/AVAILABLE VERSION

- **KELVIN**
- **DIMMABLE (OPTIONAL)**
- 27 2700K
- 30 3000K
- 40 4000K
- D Dali

COMPOSIZIONE CODICE: xxx.x ●●/##
HOW TO CREATE THE CODE: **F1000.827D/01**

CODE
F1000.8 ● ● /## — finishing
| | | |
base code kelvin dimmable

PANCA

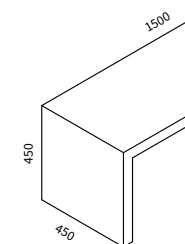

LED W	Dim.	H	Kg	lm prod 3000K	CODE
1x17,2	1500x450	450	105	650	IC510.8 ●

L'apparecchio è dotato di 2 m di cavo in neoprene | 2 m neoprene cable is included.

Dim.	H	Kg	CODE
1500x450	450	84	IC0510

Versione non elettrificata / Not electrified version

PANCHETTO

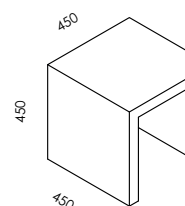

LED W	Dim.	H	Kg	lm prod 3000K	CODE
3,9	450x450	450	25	413	IC410.8 ●

Dim.	H	Kg	CODE
450x450	450	20	IC0402

Versione non elettrificata / Not electrified version

CENTO3CENTO

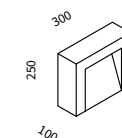

LED W	Dim.	H	Kg	lm prod 3000K	CODE
3,9	100x300	250	8	413	IC110.8 ●

L'apparecchio è dotato di 2 m di cavo in neoprene | 2 m neoprene cable is included.

PASTORALE

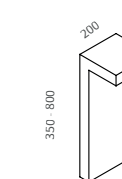

LED 230V W	Dim.	H	Kg	lm prod 3000K	CODE
8	200x200	350	8	758	IC310.8 ●
8	200x200	800	11	758	IC311.8 ●

L'apparecchio è dotato di 2 m di cavo in neoprene | 2 m neoprene cable is included.

BRIQUE O PARETE | WALL



LED 230V W	Dim.	H	Kg	lm prod 3000K	CODE
1x8	120x250	80	3	758	IC810.8 ●
2x8	120x250	80	3	1515	IC811.8 ●

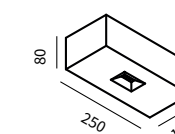

BRIQUE V PARETE | WALL



LED 230V W	Dim.	H	Kg	lm prod 3000K	CODE
1x8	120x100	200	3	758	IC910.8 ●
2x8	120x100	200	3	1515	IC911.8 ●

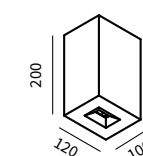

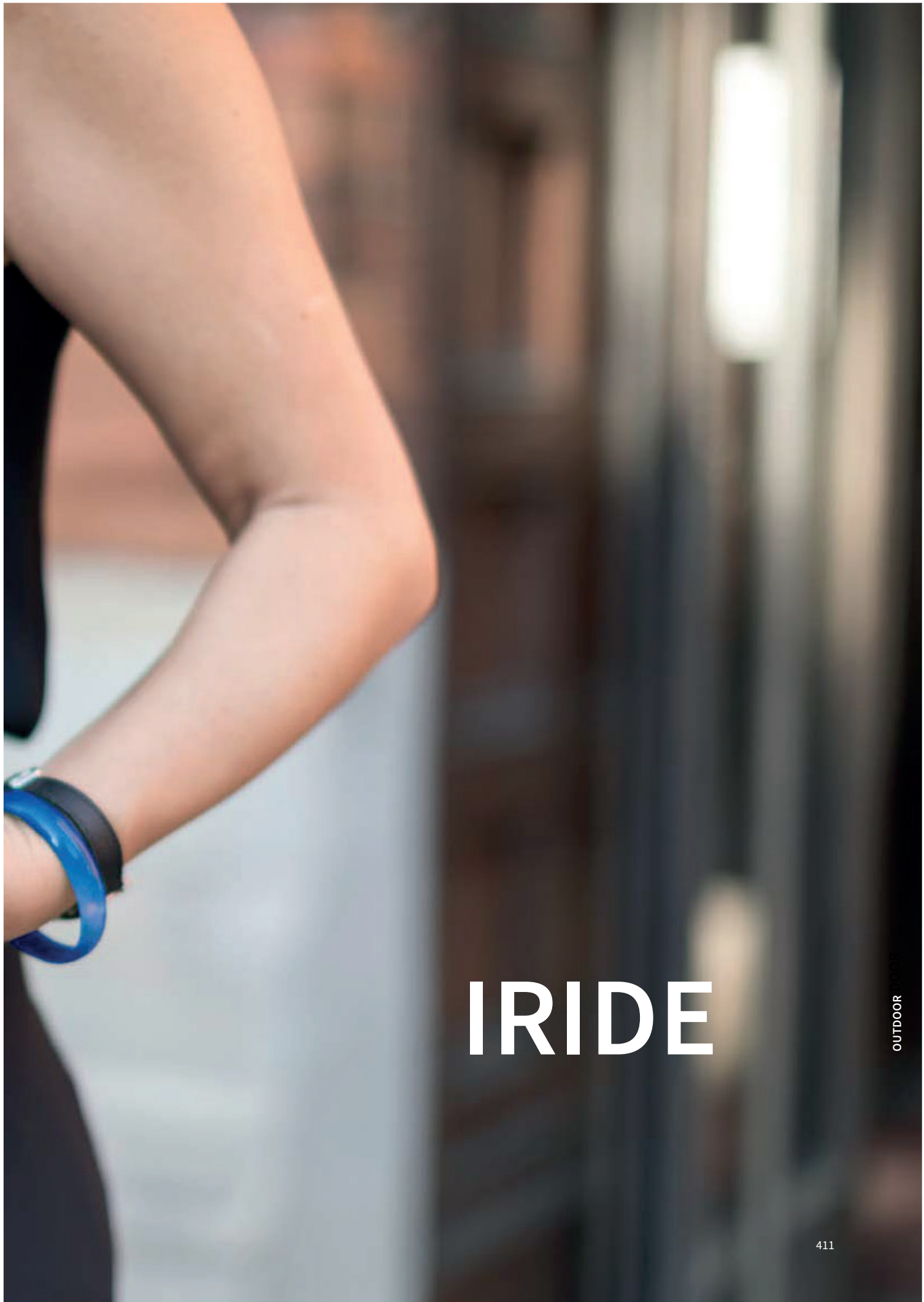

IRIDE

OUTDOOR

IRIDE

Collezione di proiettori orientabili firmati Mario Cucinella. Con sorgenti LED integrate. Possibilità di montaggio a soffitto o su binari elettrificati, misto trifase o in bassa tensione 48V. Iride è costituita da un corpo in pressofusione di alluminio verniciato e da un anello intercambiabile in bianco, nero o cromo, presente in svariate tipologie e forme create per direzionare il fascio di luce in modi differenti. Gruppi ottici completi di led ad alta resa cromatica (CRI>90), lente, housing antiabbagliamento e driver elettronico. Corpo ottico orientabile nelle versione binario, con possibilità di orientamento 0-90° rispetto all'asse orizzontale e 355° rispetto all'asse verticale, la versione a basetta offre un'ulteriore possibilità di rotazione. Ottiche spot, flood e wide. Grado di protezione IP66.

New collection of adjustable projectors by Mario Cucinella featuring integrated LED sources, ceiling or track mounted (Stucchi tracks) both for mains voltage or 48V. Iride consists of a body in painted die-cast aluminum and an interchangeable ring – in white, black or chrome finishing – for customization. Optical groups complete with high color rendering LEDs (CRI> 90), lens, anti-glare housing and electronic driver. Adjustable optical body in the track version, with the 0-90 ° orientation on the horizontal axis and 355 ° on the vertical axis; the surface mounted version offers an additional rotation possibility. Spot, flood and wide optics. IP66.

BASE OUTDOOR



UK CONFORMITY ASSESSMENT E EUROPEAN CERTIFICATION / UK CONFORMITY ASSESSTMENT AND EUROPEAN CERTIFICATION



PRODOTTI COSTRUITI CON MATERIALE RICICLABILE / PRODUCTS MADE OF RECYCLABLE MATERIAL



GARANZIA DI 5 ANNI / 5-YEAR WARRANTY



ORIENTABILE / ADJUSTABLE



DIAM.43 MM / 86 MM / 114 MM



IDONEI PER CARTONGESSO OR LATERIZIO / CALCESTRUZZO a seconda dei modelli e degli accessori. SUITABLE FOR PLASTERBOARD OR BRICKWALL / CONCRETE it depends on the model and its accessories.

KELVIN		
27		2700°K
30		3000°K
35		3500°K
40		4000°K

FASCIO/BEAM

S		SPOT
F		FLOOD
W		WIDE

FINITURE STANDARD /STANDARD FINISHINGS



/ ## FINITURA/FINISHING

- /01 corpo bianco anello bianco | white body and ring
- /02 corpo nero anello nero | black body and ring
- /21 corpo bianco, anello cromo | white body , chrome ring
- /25 corpo nero, anello cromo | black body, chrome ring
- /28 corpo bianco, anello nero | white body , black ring

CURVE FOTOMETRICHE/PHOTOMETRIC DATA

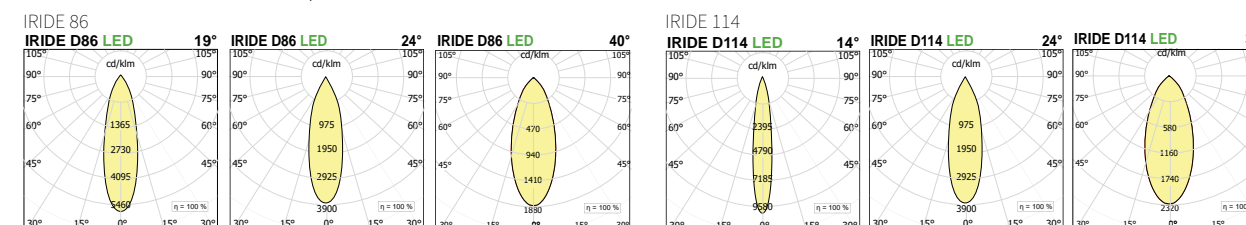

IRIDE OUTDOOR

VERSIONE SPECIALE SU PALO | SPECIAL VERSION ON POLE



IRIDE BASETTA | BASE

IRIDE BASE 86S

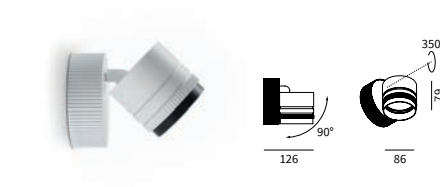

LED W	∅	Im product/beam 3000K	CODE
18	86	S19° F24° W40°	IR00IP.9 ●●● /##
26	86	1772 1832 1586	IR01IP.9 ●●● /##

IRIDE BASE 114S

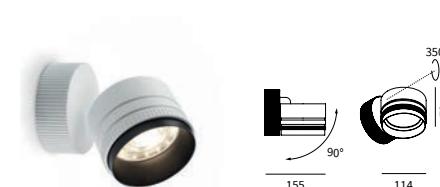

LED W	∅	Im product/beam 3000K	CODE
26	114	S14° F24° W36°	IR02IP.9 ●●● /##
34	114	2118 2531 2108	IR03IP.9 ●●● /##

IRIDE BASE 86L

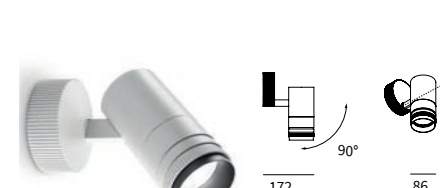

LED W	∅	Im product/beam 3000K	CODE
18	86	S19° F24° W40°	IR04IP.9 ●●● /##
26	86	1772 1832 1586	IR05IP.9 ●●● /##

IRIDE BASE 114L



LED W	∅	Im product/beam 3000K	CODE
26	114	S14° F24° W36°	IR06IP.9 ●●● /##
34	114	2118 2531 2108	IR07IP.9 ●●● /##

VERSIONI DISPONIBILI/AVAILABLE VERSION

- **KELVIN**
- 27 2700K
- 30 3000K
- 35 3500K
- 40 4000K
- TW Tunable White Dali

Note: Gli apparecchi con temperatura di colore variabile (Tunable White) vengono forniti comprensivi di alimentatore DALI | The devices with variable color temperature (Tunable White) are supplied with integrated DALI power supply.

- **FASCIO/BEAM**
- S Spot
- F Flood
- W Wide

Per i gradi vedere in tabella - For degrees check the table

- **DIMMABLE (OPTIONAL)**
- D Dali

COMPOSIZIONE CODICE: xxx.x ●●● /##

HOW TO CREATE THE CODE: **F1000.827SD /01**

CODE
F1000.8 | ● | ● | ● | - /## finishing
 base code kelvin beam dimmable

/## FINITURA/FINISHING



OUTDOOR

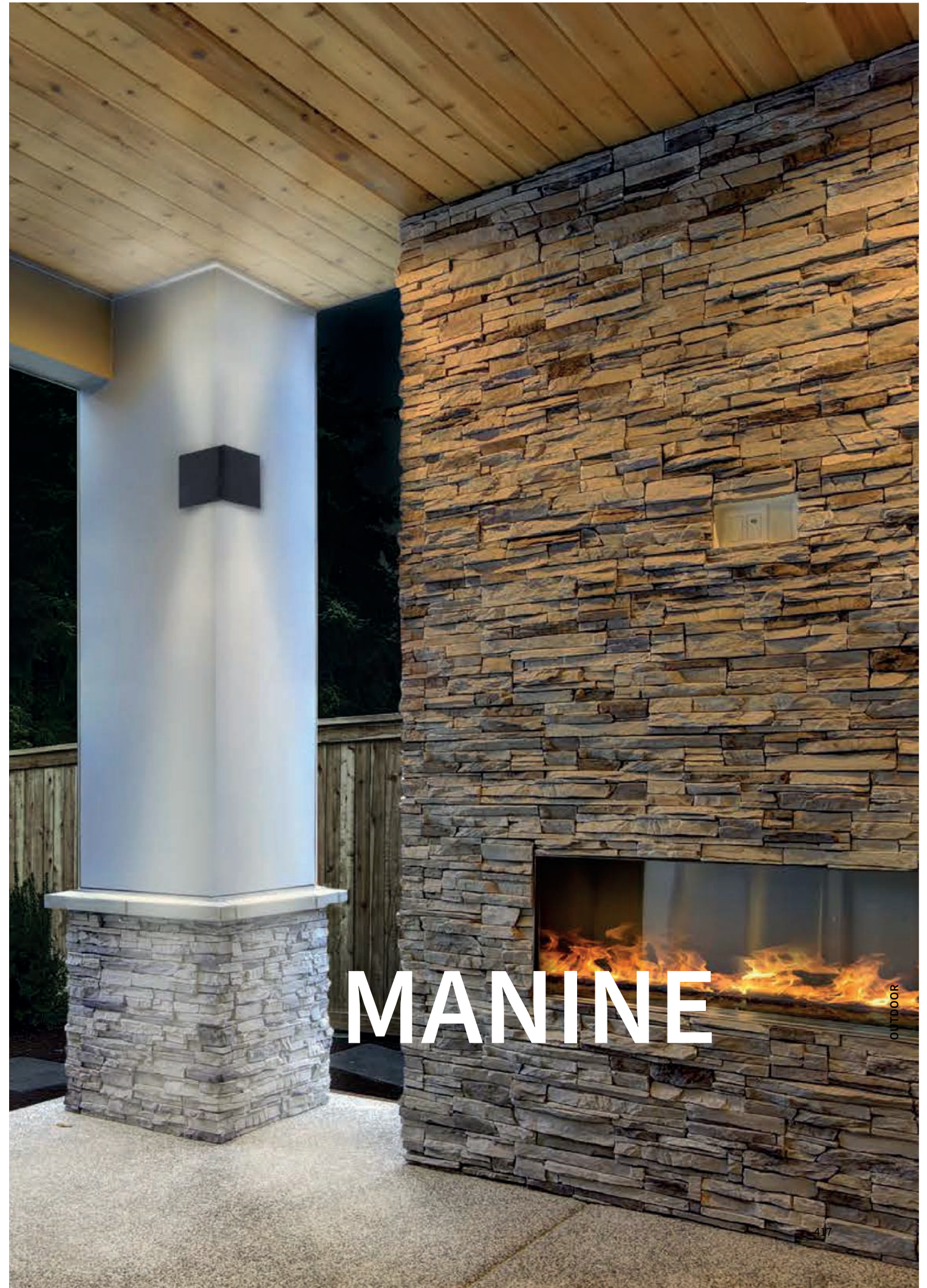

MANINE

OUTDOOR

MANINE

VERSIONE ANGOLO **ESTERNO** / **EXTERNAL ANGLE VERSION** VERSIONE ANGOLO **INTERNO** / **INTERNAL ANGLE VERSION** VERSIONE **PIATTA DA PARETE** / **FLAT WALL VERSION**



UK CONFORMITY ASSESSMENT E EUROPEAN CERTIFICATION / UK CONFORMITY ASSESSMENT AND EUROPEAN CERTIFICATION



PRODOTTI COSTRUITI CON MATERIALE RICICLABILE / PRODUCTS MADE OF RECYCLABLE MATERIAL



GARANZIA DI 5 ANNI / 5-YEAR WARRANTY

KELVIN	
27	2700°K
30	3000°K
35	3500°K
40	4000°K

FASCIO/BEAM	
	SPOT
	DIFFUSED

FINITURE STANDARD / STANDARD FINISHINGS	
/01	BIANCO/WHITE
/02	NERO/BLACK
/60	CORTEN / CORTEN

Apparecchi a parete mono o biemissione per illuminazione d'accento e di pareti ed angoli. Gruppo ottico completo di sorgenti LED professionali, con alimentazione integrata. Disponibili in versione ad angolo interno 90°, ad angolo esterno 270° oppure piatta, versione SPOT con fascio di luce stretta o DIFFUSED con fascio di luce più largo e diffuso. Corpo in metallo finitura verniciata. Grado di protezione IP40.

Single or double emission wall mounted luminaires for wall enhancing and corner lighting. Optical unit complete with professional LED sources, with integrated power supply. Available in 90° internal angle, 270° external angle or flat version, SPOT version with narrow light beam or DIFFUSED with wider and diffused light beam. Painted finish metal body. IP40.

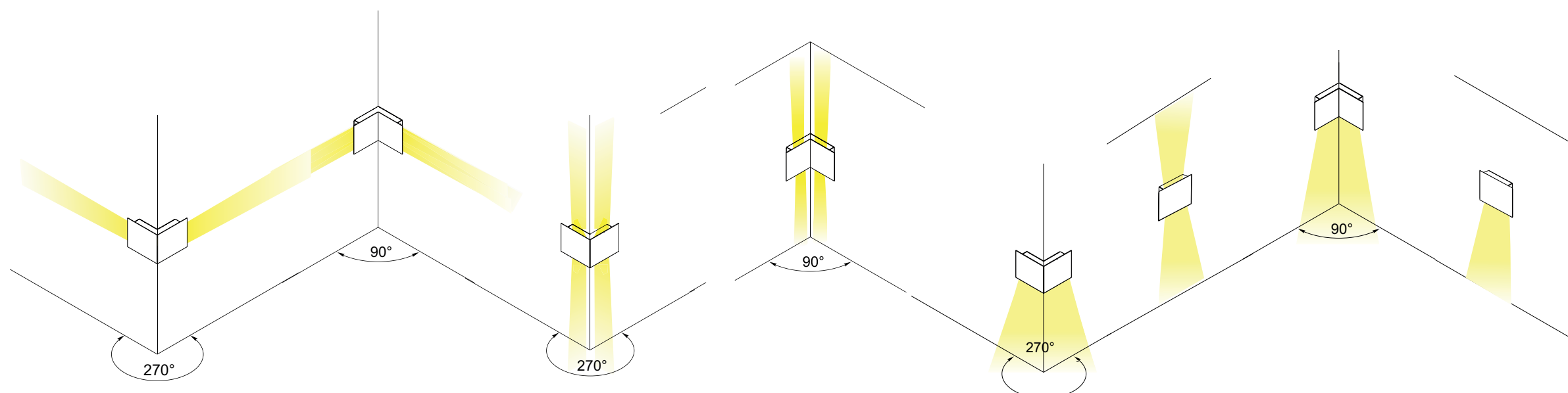

OUTDOOR

E 90 ANGOLO INTERNO | INTERNAL ANGLE

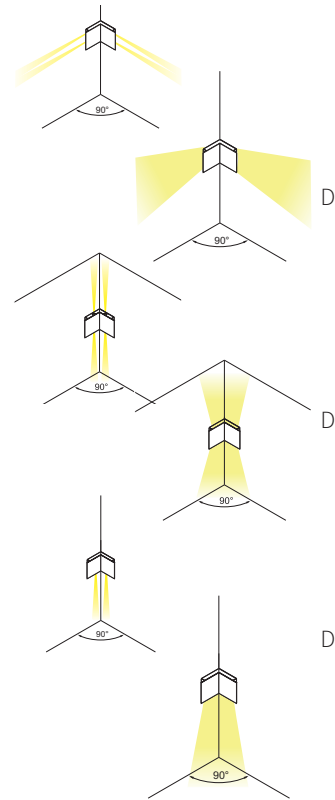
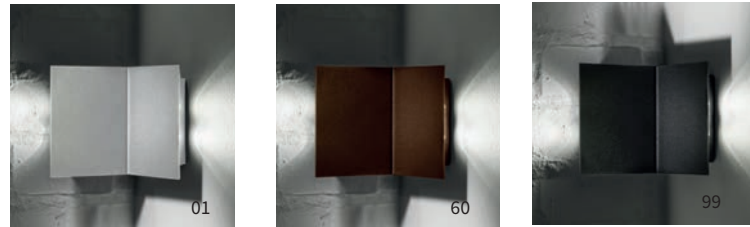
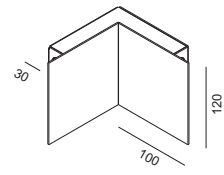

BIEMISSIONE ORIZZONTALE - HORIZONTAL DOUBLE EMISSION

LED W	Kg	lm product/beam/3000K	CODE
2x3	0,82	500	LT7101.8 ● S /##
2x13	0,82	1380	MN003P.9 ● /##

BIEMISSIONE VERTICALE - VERTICAL DOUBLE EMISSION

LED W	Kg	lm product/beam/3000K	CODE
2x3	0,82	500	LT7005.8 ● S /##
2x13	0,82	1380	MN004P.9 ● /##

MONOEMISSIONE VERTICALE - VERTICAL SINGLE EMISSION

LED W	Kg	lm product/beam/3000K	CODE
3	0,78	250	LT7103.8 ● S /##
13	0,78	690	MN005P.9 ● /##

E 270 ANGOLO ESTERNO | EXTERNAL ANGLE

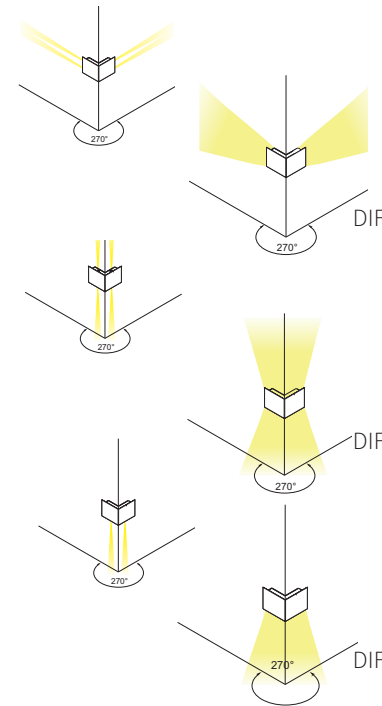
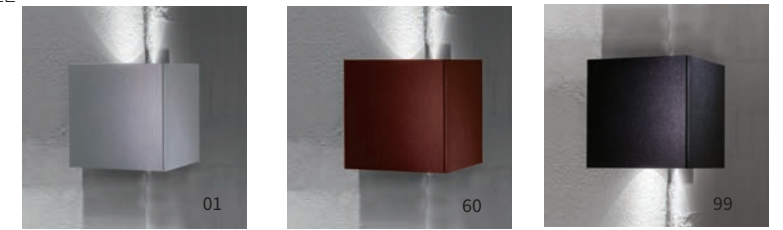
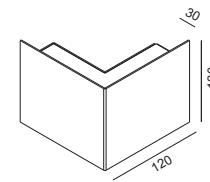

BIEMISSIONE ORIZZONTALE - HORIZONTAL DOUBLE EMISSION

LED W	Kg	lm product/beam/3000K	CODE
2x3	0,82	500	LT7001.8 ● S /##
2x13	0,82	1380	MN000P.9 ● /##

BIEMISSIONE VERTICALE - VERTICAL DOUBLE EMISSION

LED W	Kg	lm product/beam/3000K	CODE
2x3	0,82	500	LT7005.8 ● S /##
2x13	0,82	1380	MN001P.9 ● /##

MONOEMISSIONE VERTICALE - VERTICAL SINGLE EMISSION

LED W	Kg	lm product/beam/3000K	CODE
3	0,78	250	LT7003.8 ● S /##
13	0,78	690	MN002P.9 ● /##

E PARETE | WALL

Posizionabile anche in orizzontale | possible to be installed horizontally

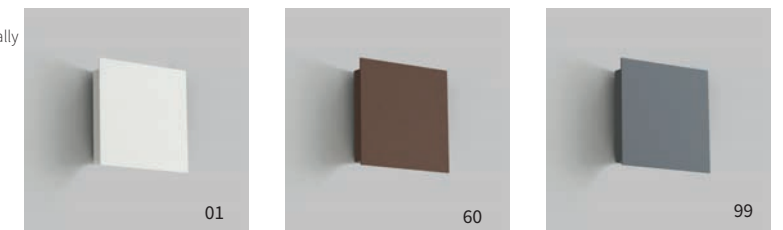
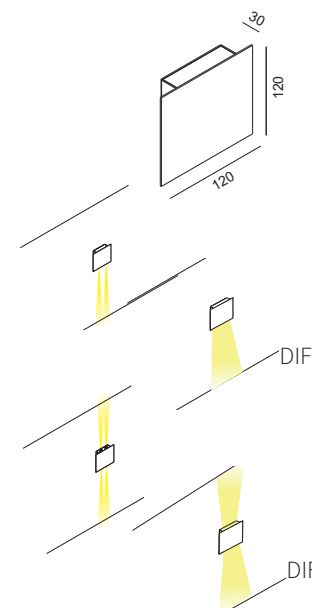

SINGLE EMISSION

LED W	Kg	lm product/beam/3000K	CODE
3	0,52	250	LT7201.8 ● S /##
13	0,52	690	MN006P.9 ● /##

DOUBLE EMISSION

LED W	Kg	lm product/beam/3000K	CODE
2x3	0,56	500	LT7301.8 ● S /##
2x13	0,56	1380	MN007P.9 ● /##

CURVE FOTOMETRICHE / PHOTOMETRIC DATA

SPOT VERSION

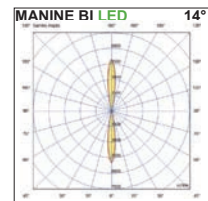
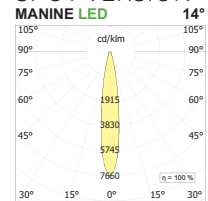

DIFFUSED VERSION

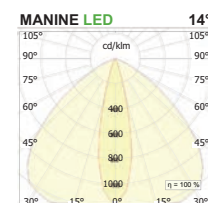

VERSIONI DISPONIBILI / AVAILABLE VERSION

- KELVIN: 27 (2700K), 30 (3000K), 35 (3500K), 40 (4000K)
- FASCIO / BEAM: S SPOT 14°

/## FINITURA / FINISHING

- 01 bianco | white
- 60 corten | corten
- 99 grafite | graphite

COMPOSIZIONE CODICE: xxx.x ●●/##

HOW TO CREATE THE CODE: F1000.827S/01

CODE: F1000.8 | 27 | S | /## — finishing

base code | kelvin | beam | 421

PHAR OUTDOOR

Proiettore professionale da parete e soffitto per esterno completo di sorgente COB LED con ottica da 38°, disponibili anche nella versione dimmerabile dali e taglio di fase ed in versione per orticoltura. Corpo e gruppo ottico di sezione cilindrica in estruso di alluminio verniciato. Snodi meccanici in acciaio. Orientabilità del gruppo ottico dalla posizione di riposo verticale di 355° sull'asse verticale e da 0° a 90° su quello orizzontale. Mantenimento della posizione grazie al blocco di puntamento.

Professional wall and ceiling outdoor projectors complete with COB LED source with 38° optic, available in DALI dimmable, phase cut version and horticulture version also. Cylindrical body and optical group in painted extruded aluminum. Mechanical steel joints. Adjustability of the optical unit from the vertical rest position of 355° on the vertical axis and from 0° to 90° on the horizontal one. Lockable pointing position.



UK CONFORMITY ASSESSMENT E EUROPEAN CERTIFICATION / UK CONFORMITY ASSESSTMENT AND EUROPEAN CERTIFICATION



PRODOTTI COSTRUITI CON MATERIALE RICICLABILE / PRODUCTS MADE OF RECYCLABLE MATERIAL



GARANZIA DI 5 ANNI / 5-YEAR WARRANTY



HORTICULTURE Disponibili versioni LED HC (Horticulture) a spettro dedicato alle piante ornamentali / HC (Horticulture) LEDs that emit a spectrum tailored to ornamental plants.

KELVIN

27		2700°K
30		3000°K
35		3500°K
40		4000°K
HC		HORTICULTURE

FASCIO/BEAM

S		SPOT 15°
F		FLOOD 24°
W		WIDE 38°

FINITURE STANDARD /STANDARD FINISHINGS

/01		BIANCO/WHITE
/02		NERO/BLACK
/49		BRONZO/BRONZE

CURVE FOTOMETRICHE/PHOTOMETRIC DATA

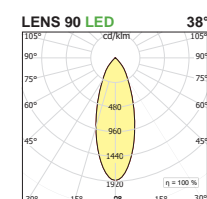

PHAR 90 PARETE/SOFFITTO WALL/CEILING PROJECTOR

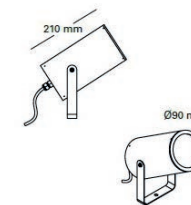

LED W	∅	H	Kg	lm product/beam.3000K W38°	CODE
32	90	180	1,6	2955	PH156IP.9 ●●●/##

VERSIONI DISPONIBILI/AVAILABLE VERSION

● KELVIN	● FASCIO/BEAM	● DIMMABLE (OPTIONAL)	/## FINITURA/FINISHING
27 2700K	● W Wide 38°	● D Dali	/01 bianco white
30 3000K			/02 nero black
35 3500K			/49 bronzo/bronze
40 4000K			

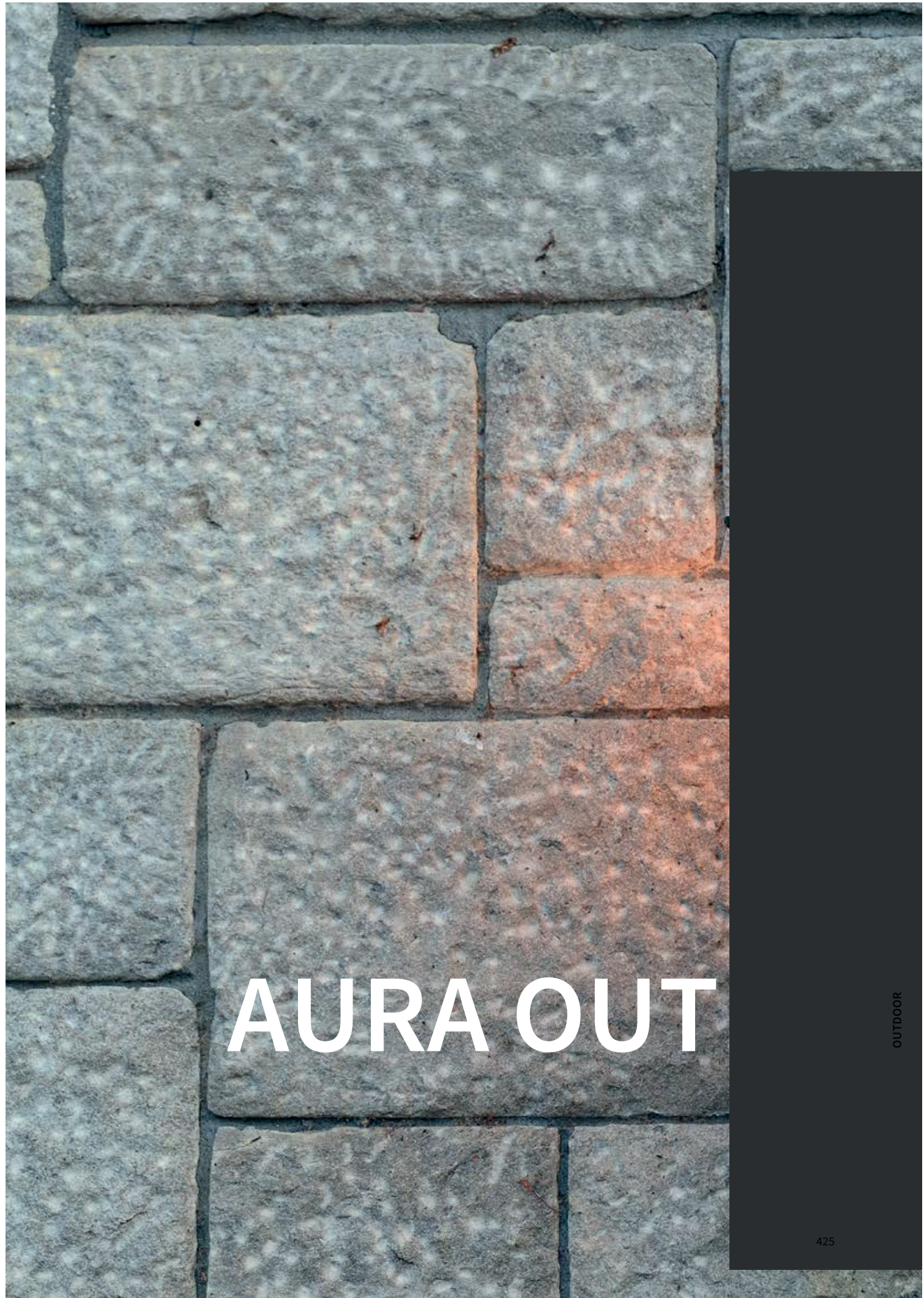

AURA OUT

AURA OUT



Raffinata eleganza che coniuga funzionalità e discrezione Aura la nuova lampada da parete biemissione, dalle linee minimaliste, completa di luce lineare led. Apparecchio disponibile in due misure, 350 mm e 520 mm, in versione di colore bianco, nero e corten. Possibilità di essere personalizzato con la cover accessoria, disponibile nei colori bianco, nero, oro champagne, corten o grafite. Classe di protezione IP66.

Refined elegance that combines functionality and discretion Aura the new wall lamp biemissione, minimalist lines, complete with linear LED light. Luminaire available in two sizes, 350 mm and 520 mm, in white, black and corten. Possibility to be customized with the accessory cover, available in white, black, champagne gold, corten or graphite. Protection class IP66.

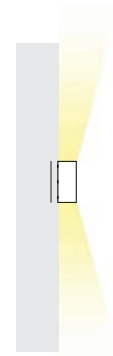

KELVIN		FINITURE STANDARD /STANDARD FINISHINGS	
27	2700°K	/01	BIANCO/WHITE
30	3000°K	/02	NERO/BLACK
35	3500°K	/44C	ORO CHAMPAGNE / CHAMPAGNE GOLD
40	4000°K	/60	CORTEN
		/99	GRAFITE/GRAPHITE

- **KELVIN**
- **DIMMABLE (OPTIONAL)**
- 27 2700K
- 30 3000K
- 35 3500K
- 40 4000K
- D** Dali Remote Driver

COMPOSIZIONE CODICE: xxx.x●●/##
 HOW TO CREATE THE CODE: **F1000.827D/01**

CODE
F1000.8 ● ● /## — finishing

base code | kelvin | dimmable



UK CONFORMITY ASSESSMENT E EUROPEAN CERTIFICATION / UK CONFORMITY ASSESSMENT AND EUROPEAN CERTIFICATION



PRODOTTI COSTRUITI CON MATERIALE RICICLABILE / PRODUCTS MADE OF RECYCLABLE MATERIAL



GARANZIA DI 5 ANNI / 5-YEAR WARRANTY

AURA OUT BIEMISSIONE

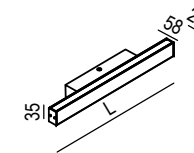

	LED 24V				
W	11	Lmm	350	lm product/beam 3000K	1203
				CODE	AU001P.9●●/##
	LED				
W	16	Lmm	520	lm product/beam 3000K	1800
				CODE	AU011P.9●●/##

ACCESSORI OPZIONALI / OPTIONAL ACCESSORIES

COVER

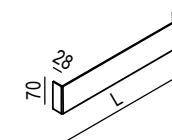

	Lmm	H	CODE
	393		AU001P.C/##
	Lmm	H	CODE
	540		AU011P.C/##

OUTDOOR

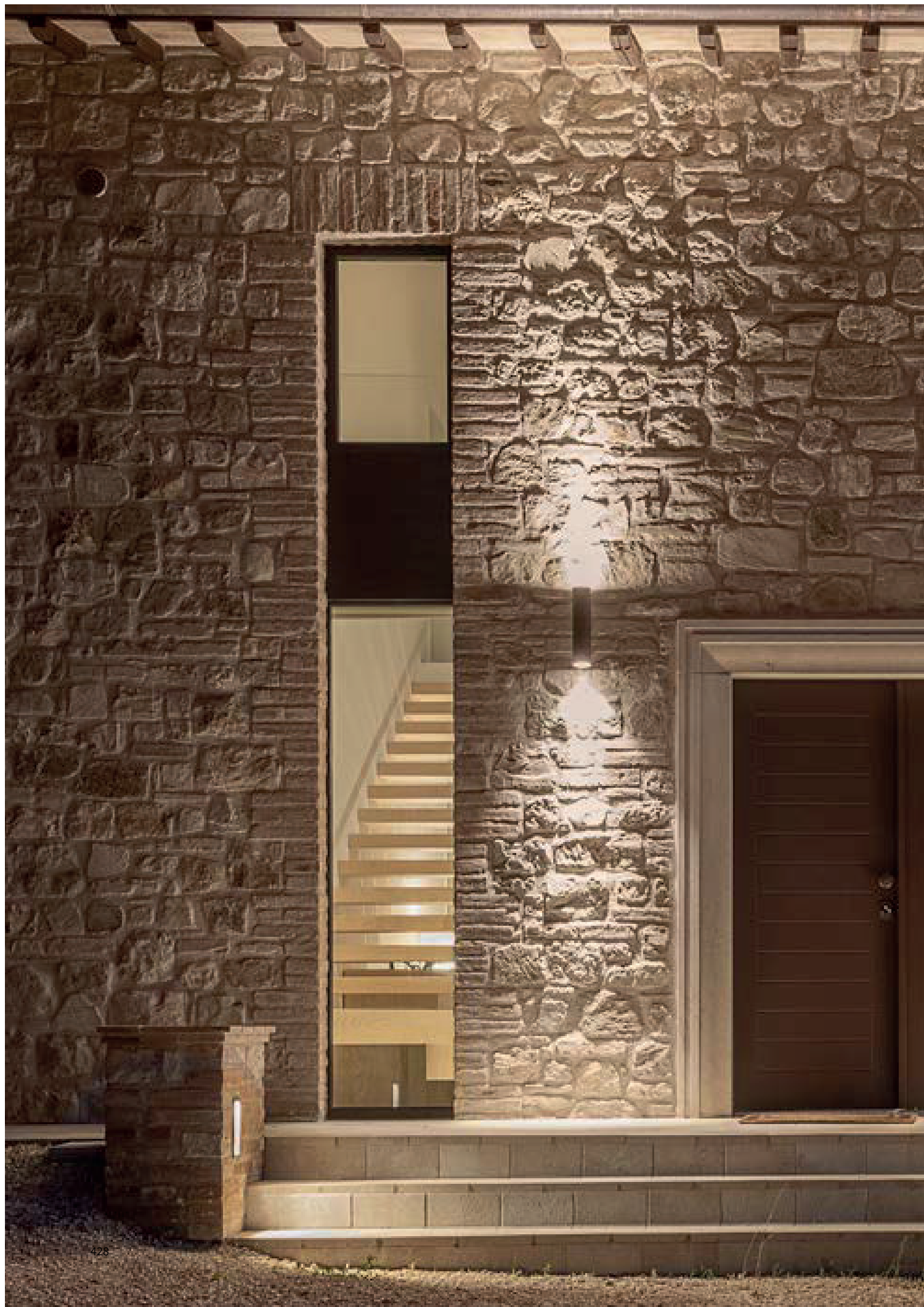

IPIPEDI

IPIPEDI

Collezione di apparecchi per esterni da soffitto, sospensione e parete per illuminazione diretta o diretta/indiretta, completi di sorgenti LED professionali o per lampade LED GU10 230V. Completati di gruppo di alimentazione. Corpo cilindrico in estruso di alluminio finitura verniciata. Completati di staffa per fissaggio a soffitto, o basetta di fissaggio a parete a seconda dei modelli. Grado di protezione IP54.

Ceiling, suspended or wall luminaires for direct or direct/indirect lighting, complete with professional LED sources or GU10 230V LED bulbs. Integrated power supply unit. Cylindrical body in extruded aluminum with painted finish. Complete with ceiling mounting brackets or wall fixing base according to the models. IP54.



UK CONFORMITY ASSESSMENT E EUROPEAN CERTIFICATION / UK CONFORMITY ASSESSMENT AND EUROPEAN CERTIFICATION



PRODOTTI COSTRUITI CON MATERIALE RICICLABILE / PRODUCTS MADE OF RECYCLABLE MATERIAL



GARANZIA DI 5 ANNI / 5-YEAR WARRANTY



VERSIONI CON SORGENTE LED GU10 DISPONIBILI / AVAILABLE GU10 LIGHT SOURCE VERSION

LAMPADA DA SOFFITTO - CEILING LAMP

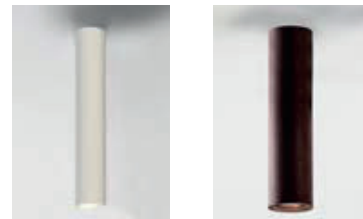

LAMPADA DA PARETE - WALL LAMP

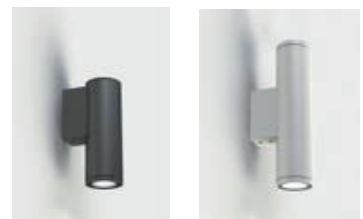

KELVIN	
27	2700°K
30	3000°K
35	3500°K
40	4000°K

FASCIO/BEAM	
F	FLOOD
W	WIDE

FINITURE STANDARD / STANDARD FINISHINGS	
/01	BIANCO/WHITE
/02	NERO/BLACK
/60	CORTEN
/99	GRAFITE/GRAPHITE

CURVE FOTOMETRICHE/PHOTOMETRIC DATA

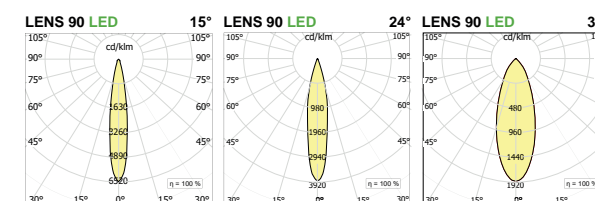

IPIPEDI

PARETE | WALL GU10



Ø55

R55A PARETE MONO EMISSIONE | SINGLE EMISSION WALL

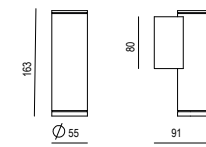

GU10 LED 230V			
W	Ø	H	
50	55	163	

CODE
PP040/##

R55A2 PARETE BI EMISSIONE | DOUBLE EMISSION WALL

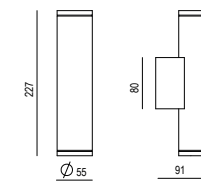

GU10 LED 230V			
W	Ø	H	
50	55	227	

CODE
PP041/##

COMPOSIZIONE CODICE: xxx.x /##

HOW TO CREATE THE CODE: F1000/01

CODE

F1000 /## — finishing

|
base code

/## FINITURA/FINISHING

- /01 bianco/white
- /02 nero/black
- /60 corten
- /99 grafite/graphite

OUTDOOR

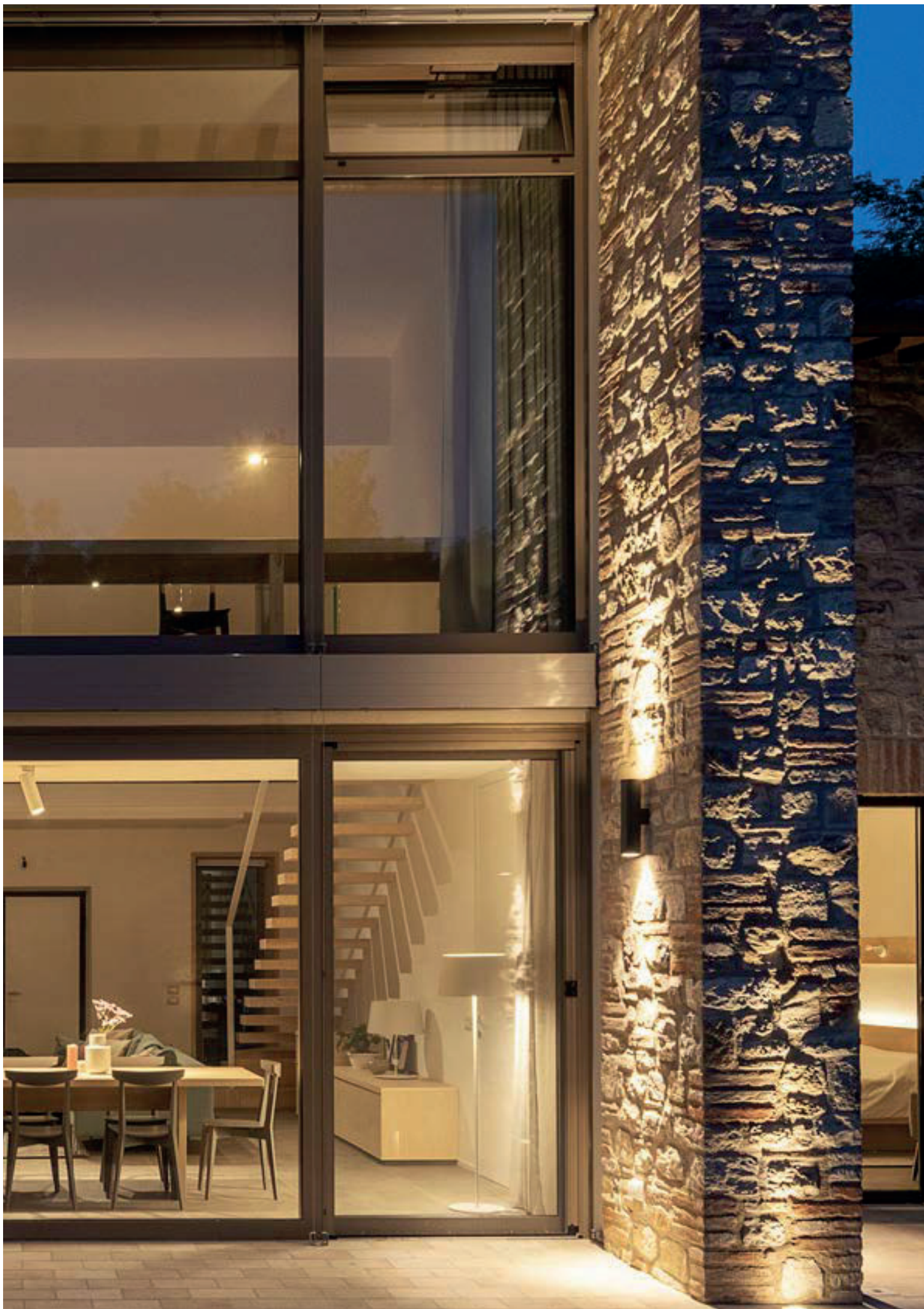

IPIPEDI

PARETE | WALL LED

Ø90

I-PIPEDI R90A PARETE MONO EMISSIONE SINGLE EMISSION WALL

Versione base con driver dimmerabile taglio di fase incluso | Trailing/leading edge dimmable included in Led base version.

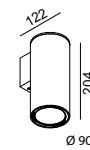

LED W	∅	H	lm product/beam 3000K F24°	W38°	CODE
17	90	204	1827	1905	PP521.9 ●●●/##

I-PIPEDI R90A2 PARETE BI EMISSIONE DOUBLE EMISSION WALL

Versione base con driver dimmerabile taglio di fase incluso | Trailing/leading edge dimmable included in Led base version.

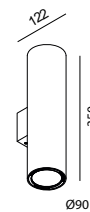

LED W	∅	H	lm product/beam 3000K F24°	W38°	CODE
2x17	90	350	3654	3810	PP621.9 ●●●/##

● KELVIN

- 27 2700K
- 30 3000K
- 35 3500K
- 40 4000K

● FASCIO/BEAM

- F Flood
- W Wide

Per i gradi vedere in tabella -
For degrees check the table

DIMMABLE (OPTIONAL)

- D Dali

/## FINITURA/FINISHING

- /01 bianco/white
- /02 nero/black
- /60 corten
- /99 grafite/graphite

COMPOSIZIONE CODICE: xxx.x ●●●/##

HOW TO CREATE THE CODE: F1000.827SD/01

CODE
F1000.8 ●●●/## — finishing

base code | kelvin | beam | dimmable

IPIPEDI

SOFFITTO | CEILING



Ø90 H90

I-PIPEDI R90 H90 SOFFITTO CEILING

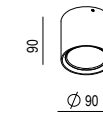

LED W	Ø	H	Kg	lm product/beam 3000K F24°	W38°	CODE
12	90	90	1,0	1289	-	PP165IP.9 ●●●/##
17	90	90	1,4	1827	1905	PP166IP.9 ●●●/##
24,3	90	90	1,4	2356	2430	PP167IP.9 ●●●/##



Ø90 H300

I-PIPEDI R90 SOFFITTO CEILING

Versione base con driver dimmerabile taglio di fase incluso | Trailing/leading edge dimmable included in Led base version.

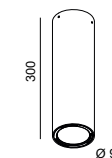

LED W	Ø	H	lm product/beam 3000K F24°	W38°	CODE
17	90	300	1827	1905	PP421.9 ●●●/##



GU10 LED 230V W	Ø	H	CODE
1x max 50	90	300	PP422 /##



● KELVIN

- 27 2700K
- 30 3000K
- 35 3500K
- 40 4000K

● FASCIO/BEAM

- F Flood
- W Wide

Per i gradi vedere in tabella -
For degrees check the table

DIMMABLE (OPTIONAL)

- D Dali

/## FINITURA/FINISHING

- /01 bianco/white
- /02 nero/black
- /60 Corten
- /99 grafite/graphite

COMPOSIZIONE CODICE: xxx.x ●●●/##

HOW TO CREATE THE CODE: F1000.827S□/01

CODE
F1000.8 ●●●/## — finishing

base code kelvin beam dimmable



LEVA & LEVA QUADRA

LEVA & LEVA QUADRA

Collezione di apparecchi per esterni da soffitto od incasso, trimless o con battura, con sorgenti LED Chip On Board integrate. Corpo apparecchio in estruso di alluminio verniciato. Gruppi ottici antiabbagliamento completi di led chip on board (CRI>90) e lenti. Ottiche spot, flood, wideflood UGR<14. Alimentatori elettronici remoti on/off da installarsi remoti tranne che per il modello Leva5. Grado di protezione IP56.

Collection of ceiling or recessed outdoor luminaires, trimless or trimmed, with integrated Chip On Board LED sources. Luminaire body in painted extruded aluminum. Anti-glare optical groups complete with LED chip on board (CRI> 90) and lenses. Spot, flood, wideflood optics UGR <14. Remote electronic ballasts to be installed remotely except for the Leva5 model (on/off integrated driver). IP56.



UK CONFORMITY ASSESSMENT E EUROPEAN CERTIFICATION / UK CONFORMITY ASSESSMENT AND EUROPEAN CERTIFICATION



PRODOTTI COSTRUITI CON MATERIALE RICICLABILE / PRODUCTS MADE OF RECYCLABLE MATERIAL



GARANZIA DI 5 ANNI / 5-YEAR WARRANTY

KELVIN	FASCIO/BEAM	FINITURE STANDARD /STANDARD FINISHINGS
27 2700°K	S SPOT 20°	/01 TELAIO BIANCO OTTICA NERA/ WHITE FRAME BLACK OPTIC
30 3000°K	F FLOOD 32°	/02 TELAIO NERO OTTICA NERA/ BLACK FRAME BLACK OPTIC
35 3500°K	W WIDE 50°	/41 TELAIO BIANCO OTTICA BIANCA/ WHITE FRAME WHITE OPTIC
40 4000°K	Z ASYMMETRIC 41°X18°	/42 TELAIO NERO OTTICA ORO/ BLACK FRAME GOLD OPTIC
		/43 TELAIO BRONZO OTTICA NERO/ BRONZE FRAME BLACK OPTIC
		/45 TELAIO BRONZE OTTICA NERA/ BRONZE FRAME BLACK OPTIC

TW Tunable White 2700 – 5000°K
La tecnologia Tunable White consente di controllare la temperatura di colore delle sorgenti luminose permettendo di scegliere quella più adatta tra luce bianca calda e fredda. / Tunable White technology allows you to control the color temperature of light sources allowing you to choose the most suitable between warm and cold white light.

CURVE FOTOMETRICHE/PHOTOMETRIC DATA

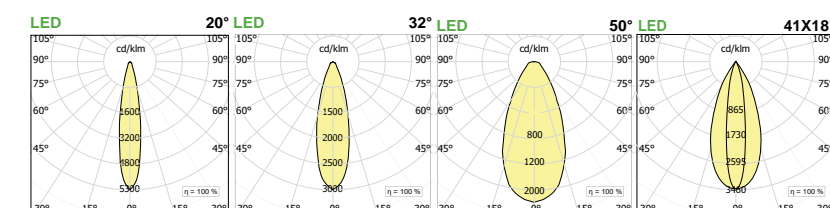

LEVA INCASSI | DOWNLIGHT

TRIMLESS

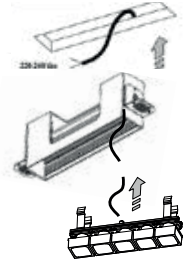

OR FRAME

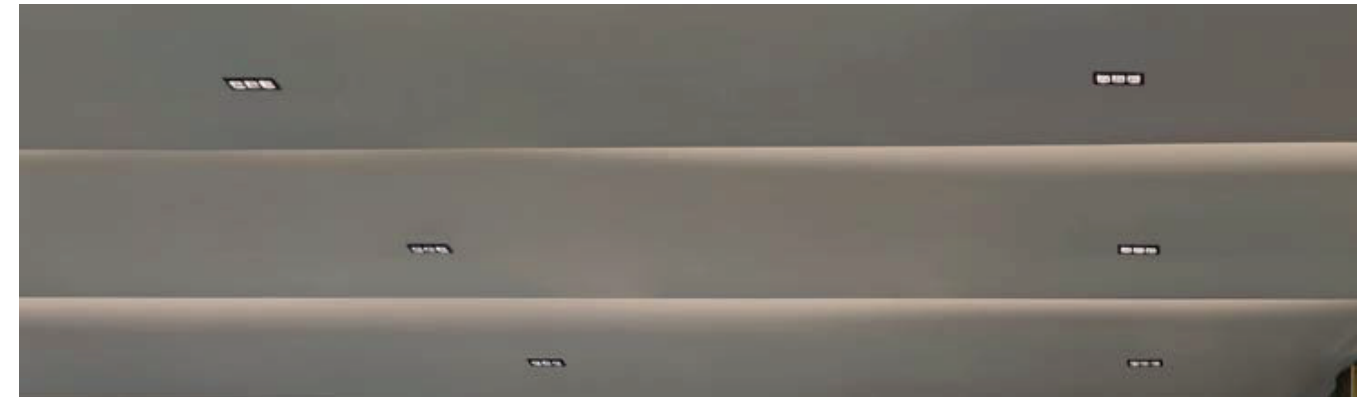
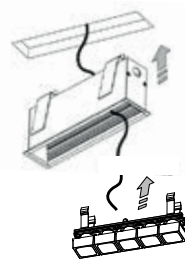

LEVA 1 INCASSO DOWNLIGHT

TRIMLESS A+C



32x36

Dim.	H	Kg	CODE
30x34	62	0,06	LV001A

FRAME B + C



34x36

Dim.	H	Kg	CODE	/##
40x42	62	0,06	LV001F	/01 /02



KIT LED		Dim.		H		Kg		Im prod./beam 3000K				CODE
W	mA							S20°	F32°	W50°	Z41°x18°	
2,2	700	27x30	60	0,02	200	186	166	175				LV001P.9 ●● / ##

Da completare con cassa e alimentatore da installare remoto in scatola di derivazione | To be completed with box and power supply to be installed in a remote junction box

LEVA 5 INCASSO LEVA 5 DOWNLIGHT

TRIMLESS A+C

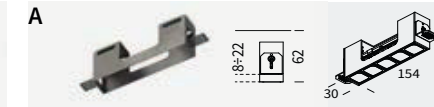

32x156

Dim.	H	Kg	CODE
30x154	62	0,15	LV005A

FRAME B + C

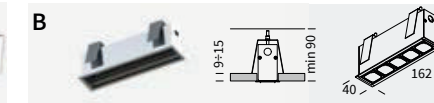

34x156

Dim.	H	Kg	CODE	/##
40x162	65	0,15	LV005F	/01 /02



KIT LED		Dim.		H		Kg		Im product/beam 3000K				CODE
W	mA							S20°	F32°	W50°	Z41°x18°	
11	700	27x150	60	0,10	1002	931	828	877				LV005P.9 ●● / ##

Da completare con cassa e alimentatore da installare remoto in scatola di derivazione | To be completed with box and power supply to be installed in a remote junction box

LEVA 3 INCASSO DOWNLIGHT

TRIMLESS A+C

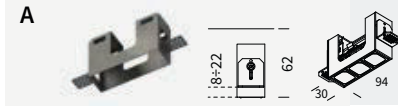

32x96

Dim.	H	Kg	CODE
30x94	62	0,12	LV003A

FRAME B + C

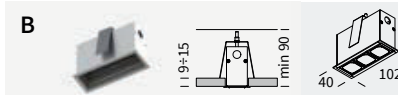

34x96

Dim.	H	Kg	CODE	/##
40x102	65	0,12	LV003F	/01 /02



KIT LED		Dim.		H		Kg		Im product/beam 3000K				CODE
W	mA							S20°	F32°	W50°	Z41°x18°	
6,6	700	27x90	60	0,06	601	558	496	526				LV003P.9 ●● / ##

Da completare con cassa e alimentatore da installare remoto in scatola di derivazione | To be completed with box and power supply to be installed in a remote junction box

ACCESSORI OPTIONAL/ OPTIONAL ACCESSORIES

CASSAFORMA PER MURATURA, CALCESTRUZZO E RIVESTIMENTI ISOLANTI | WALLBOX FOR BRICKWALL, CONCRETE AND INSULATION

CASSAFORMA PER LEVA3 | WALLBOX FOR LEVA3

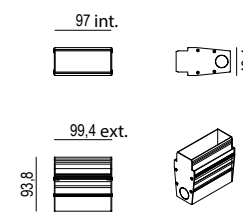

LEVA 3	L. mm int.	L. mm ext.	WxH	CODE
	97	99,4	48,4 X 93,8	CCLV03

CASSAFORMA PER LEVA5 | WALLBOX FOR LEVA5

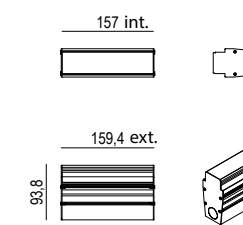

LEVA 5	L. mm int.	L. mm ext.	WxH	CODE
	157	159,4	48,4 X 93,8	CCLV05

VERSIONI DISPONIBILI/AVAILABLE VERSION

- KELVIN**
 - 27 2700K
 - 30 3000K
 - 35 3500K
 - 40 4000K
- KELVIN**
 - 27 2700K
 - 30 3000K
 - 35 3500K
 - 40 4000K

FASCIO/BEAM

- S** Spot
- F** Flood
- W** Wide
- Z** Asymmetric

FINITURA KIT LED C / FINISHING KIT LED C

- /01** bianco | white
- /02** nero | black
- /04** oro | gold

FINITURA CASSA FRAME B / FINISHING FRAME BOX B

- /01** bianco | white
- /02** nero | black
- /49** bronzo | bronze

Per i gradi vedere in tabella - For degrees check the table

700 DRIVERS VEDI | SEE P.452



LEVA QUADRA 4 INCASSO DOWNLIGHT



36X60



TRIMLESS A+C



A

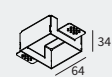

CASSA OBBLIGATORIA - COMPULSORY BOX

Dim.	H	Kg	CODE
64x64	34	0,07	LV301M

FRAME B + C



B

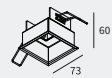

CASSA OBBLIGATORIA - COMPULSORY BOX

Dim.	H	Kg	CODE	/##
73x73	60	0,15	LV301F	/01 /02

C

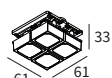

LED	W	mA	Dim.	H	Kg	Im product/beam 3000K	S20°	F32°	W50°	CODE
700	8,8	700	61x61	33	0,2	800	745	662		LV351K.9 ●●/##

Da completare con cassa e alimentatore da installare remoto | To be completed with box and remote driver.

LEVA QUADRA 9 INCASSO DOWNLIGHT



46X70

96x96



TRIMLESS A+C



A



CASSA OBBLIGATORIA - COMPULSORY BOX

Dim.	H	Kg	CODE
94x94	34	0,12	LV302M

FRAME B + C



B



CASSA OBBLIGATORIA - COMPULSORY BOX

Dim.	H	Kg	CODE	/##
103x103	60	0,25	LV302F	/01 /02

C

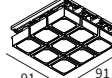

KIT LED	W	mA	Dim.	H	Kg	Im product/beam 3000K	S20°	F32°	W50°	CODE
700	19,8	700	91x91	33	0,35	1800	1676	1490		LV352K.9 ●●/##

Da completare con cassa e alimentatore da installare remoto | To be completed with box and remote driver.

LEVA SOFFITTO/PARETE WALL/CEILING

VERSIONI ALIMENTATORI ESCLUSI - POWER SUPPLIER NOT INCLUDED

LEVA SOFFITTO/PARETE 1 WALL/CEILING



LED	W	mA	Dim.	H	Kg	Im prod./beam 3000K	S20°	F32°	W50°	Z41°x18°	CODE
700	2,2	700	32x40	62	0,16	200	186	166	175		LV021P.9 ●●/##

Da completare con alimentatore da installare remoto in scatola di derivazione. Per installazione in Container Minifile ordinare n.1 LTM210 staffa per fissaggio modulo luminoso all'interno della cassaforma. | To be completed with power supply to be installed in a remote junction box. To install in Container Minifile order n.1 LTM210 single bracket to fix the lighting module within the wallbox.

LEVA SOFFITTO/PARETE 3 WALL/CEILING



LED	W	mA	Dim.	H	Kg	Im prod./beam 3000K	S20°	F32°	W50°	Z41°x18°	CODE
700	6,6	700	32x100	62	0,26	601	558	496	526		LV026P.9 ●●/##

Da completare con alimentatore da installare remoto in scatola di derivazione. Per installazione in Container Minifile ordinare n.2 LTM210 staffa per fissaggio modulo luminoso all'interno della cassaforma. | To be completed with power supply to be installed in a remote junction box. To install in Container Minifile order n.2 LTM210 single bracket to fix the lighting module within the wallbox.

LEVA SOFFITTO/PARETE 5 WALL/CEILING



LED	W	Dim.	H	Kg	Im prod./beam 3000K	S20°	F32°	W50°	Z41°x18°	CODE
700	11	32x160	62	0,34	1002	931	828	877		LV027P.9 ●●/##

Per installazione in Container Minifile ordinare n.2 LTM210 staffa per fissaggio modulo luminoso all'interno della cassaforma. To install in Container Minifile order n.2 LTM210 single bracket to fix the lighting module within the wallbox.

VERSIONI ALIMENTATORI INCLUSI | INTEGRATED POWER SUPPLIES (ON/OFF)

LEVA SOFFITTO/PARETE 10 WALL/CEILING



LED	W	Dim.	H	Kg	Im prod./beam 3000K	S20°	F32°	W50°	Z41°x18°	CODE
700	22	32x310	62	0,66	2004	1862	1656	1754		LV028P.9 ●●/##

Per installazione in Container Minifile ordinare n.2 LTM210 staffa per fissaggio modulo luminoso all'interno della cassaforma. To install in Container Minifile order n.2 LTM210 single bracket to fix the lighting module within the wallbox.

VERSIONI DISPONIBILI/AVAILABLE VERSION

● KELVIN

- 27 2700K
- 30 3000K
- 35 3500K
- 40 4000K

TW Tunable White Dali
l'alimentatore è da installare remoto | driver to instal remotely.

● FASCIO/BEAM

- S Spot
- F Flood
- W Wide
- Z Asymmetric

Per i gradi vedere in tabella - For degrees check the table

○ FASCIO/BEAM

- S Spot
- F Flood
- W Wide

/## FINITURA/FINISHING

- /01 telaio bianco, ottica nera | white frame, black optic
- /02 telaio nero, ottica nera | black frame, black optic
- /41 telaio bianco, ottica bianca | white frame, white optic
- /42 telaio nero, ottica oro | black frame, gold optic

700 DRIVERS VEDI | SEE P.452

OUTDOOR

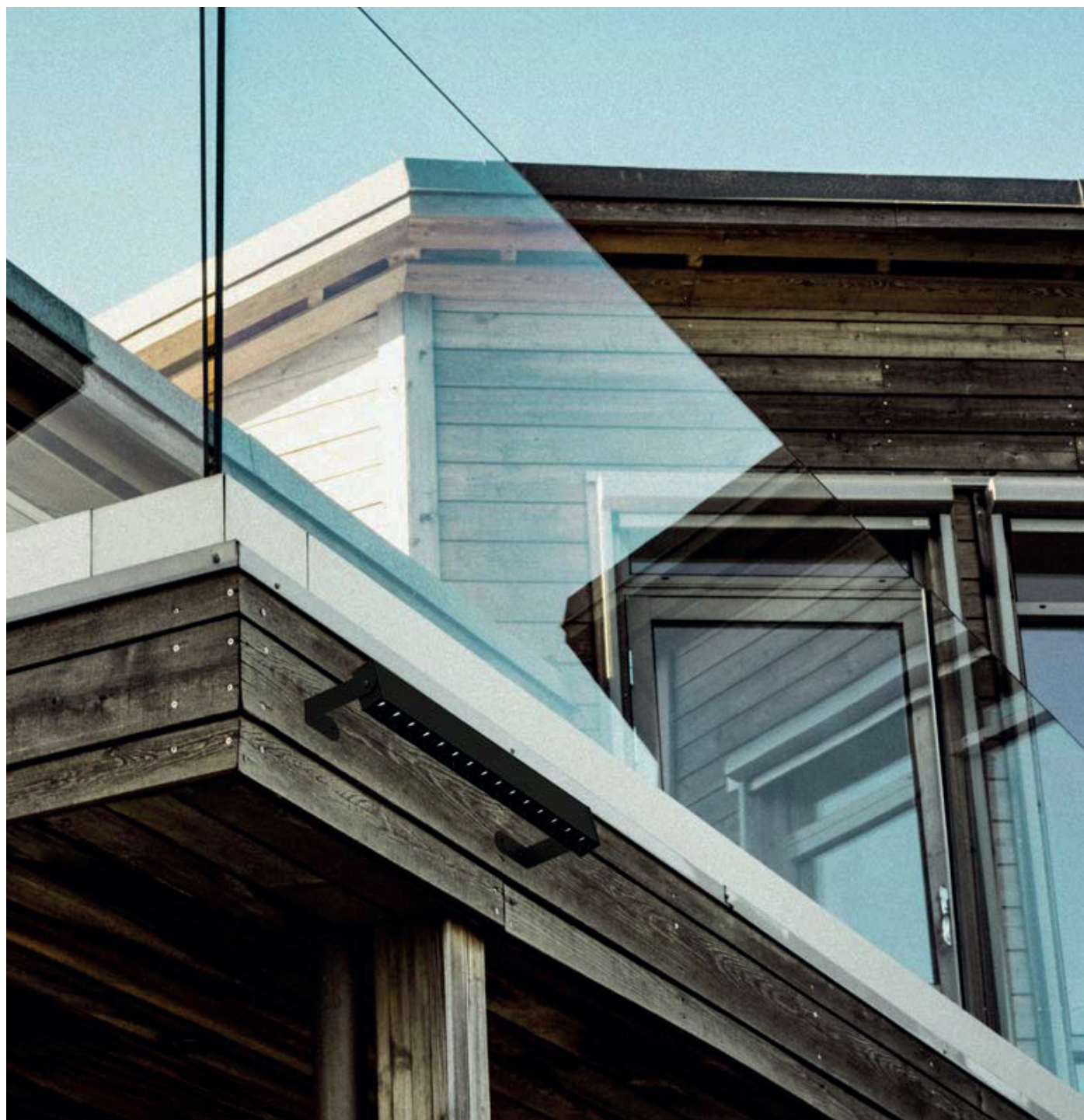

LEVA GRAFFA

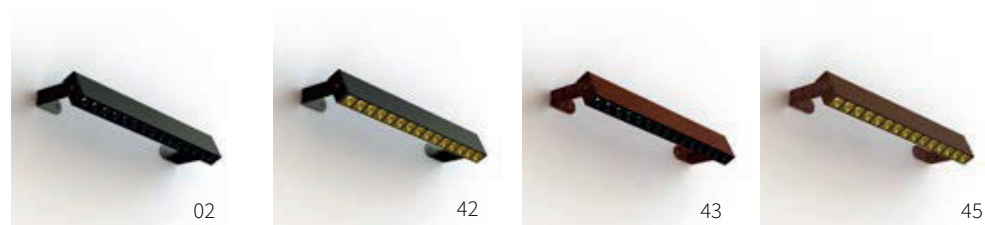

LEVA CON GRAFFA | LEVA WITH WALL BRACKET

LEVA CON GRAFFA 450 LEVA WITH WALL BRACKET 450

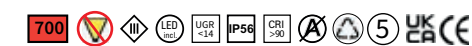

W	mA	Dim.	H	Kg	Im product/beam 3000K	S20°	F32°	W50°	Z41°x18°	CODE
33	700	112x470	62	0,35	3000	2793	2484	2631	LV705P.9	●●/##

Da completare con alimentatore da installare remoto in scatola di derivazione | To be completed with power supply to be installed in a remote junction box

LEVA CON GRAFFA 600 LEVA WITH WALL BRACKET 600

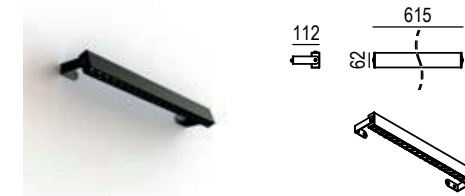

W	Dim.	H	Kg	Im prod./beam 3000K	S20°	F32°	W50°	Z41°x18°	CODE
44	112x615	62	1,2	4000	3724	3312	3580	LV706P.9	●●/##

Da completare con alimentatore da installare remoto in scatola di derivazione | To be completed with power supply to be installed in a remote junction box

LEVA CON GRAFFA 900 LEVA WITH WALL BRACKET 900

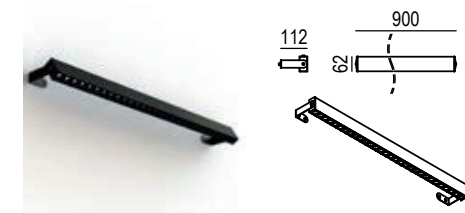

W	mA	Dim.	H	Kg	Im product/beam 3000K	S20°	F32°	W50°	Z41°x18°	CODE
66	700	112x900	62	0,35	6000	5586	4968	5262	LV707P.9	●●/##

Da completare con alimentatore da installare remoto in scatola di derivazione | To be completed with power supply to be installed in a remote junction box

BOX DRIVER BOX DRIVERS



Dim.	H	CODE
73x210	68	LV70BX



OUTDOOR

VERSIONI DISPONIBILI/AVAILABLE VERSION

- **KELVIN**
 - 27 2700K
 - 30 3000K
 - 35 3500K
 - 40 4000K
- **FASCIO/BEAM**
 - S Spot
 - F Flood
 - W Wide
 - Z Asymmetric



Per i gradi vedere in tabella - For degree check the table

/## FINITURA/FINISHING

- /02 telaio nero, ottica nera | black frame, black optic
- /42 telaio nero, ottica oro | black frame, gold optic
- /43 telaio bronzo, ottica nera | bronze frame, black optic
- /45 telaio bronzo, ottica oro | bronze frame, gold optic

700 DRIVERS VEDI | SEEP.452



Collezione di apparecchi per esterni da soffitto od incasso per illuminazione diretta diffusa, per sorgenti lineari LED. Alimentazione elettronica integrata. Corpo in estruso di alluminio 78x75 mm. Finitura verniciata o anodizzata. Completati di staffe di fissaggio al controsoffitto con sistema di regolazione a vite, testate di chiusura laterali e schermo diffondente in policarbonato opalino bianco. Grado di protezione IP54.

Collection of outdoor ceiling or recessed luminaires for direct diffused lighting, for linear LED sources. Integrated electronic power supply. Extruded aluminum body 78x75 mm. Painted or anodized finish. Complete with fixing brackets to the false ceiling with screw adjustment system, end caps and diffusing screen in white opal polycarbonate. IP54.

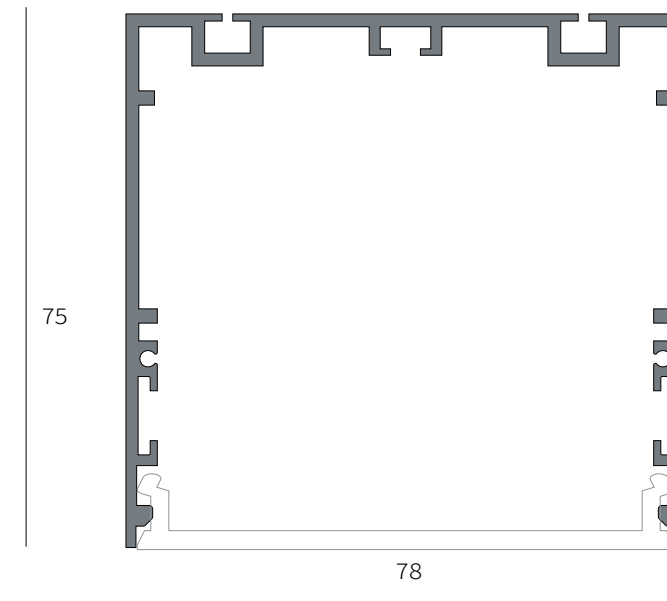

UK CONFORMITY ASSESSMENT E EUROPEAN CERTIFICATION / UK CONFORMITY ASSESSMENT AND EUROPEAN CERTIFICATION



PRODOTTI COSTRUITI CON MATERIALE RICICLABILE / PRODUCTS MADE OF RECYCLABLE MATERIAL



GARANZIA DI 5 ANNI / 5-YEAR WARRANTY



VERSIONI HORTICULTURE/AVAILABLE HORTICULTURE VERSION

Possibilità di montare lampade adatte alla crescita delle piante indoor / Horticulture version suitable for growth indoor
Il tocco green di Lucifero's. I profili File hanno la possibilità di essere equipaggiati con spettri di luce adatti all'orticoltura. L'illuminazione adatta al verde converte l'energia elettrica in fotoni che stimolano la fotosintesi delle piante anche in assenza di luce naturale. La presenza delle piante conferisce agli ambienti, siano essi abitazioni o ambienti di lavoro, un'atmosfera di qualità: i rumori vengono attutiti, l'aria viene ossigenata e la concentrazione aumenta. Le piante hanno effetti benefici anche a livello psicologico attenuando lo stress e aumentando la produttività lavorativa.





TUNABLE WHITE / TUNABLE WHITE



DIFFUSORE OPAL / OPAL DIFFUSER

KELVIN

27  2700°K

30  3000°K

40  4000°K

HC 

HORTICULTURE

TW 

Tunable White 2700 – 5000°K

La tecnologia Tunable White consente di controllare la temperatura di colore delle sorgenti luminose permettendo di scegliere quella più adatta tra luce bianca calda e fredda. / Tunable White technology allows you to control the color temperature of light sources allowing you to choose the most suitable between warm and cold white light.

FINITURE STANDARD /STANDARD FINISHINGS

/01  BIANCO/WHITE

/02  NERO/BLACK

/27  ALLUMINIO ANODIZZATO/
ANODIZED ALUMINIUM

/49  BRONZO / BRONZE

CURVE FOTOMETRICHE/PHOTOMETRIC DATA

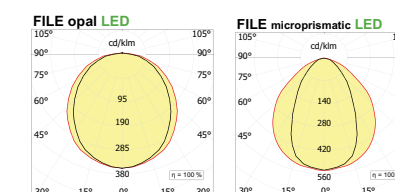

FILE 2 INCASSO RASATO
PER CARTONGESSO A LUCE DIRETTA E DIFFUSA / FOR FALSE CEILING DIRECT AND DIFFUSED LIGHT



taglio per incasso/ recessed hole dimension 82xL+2

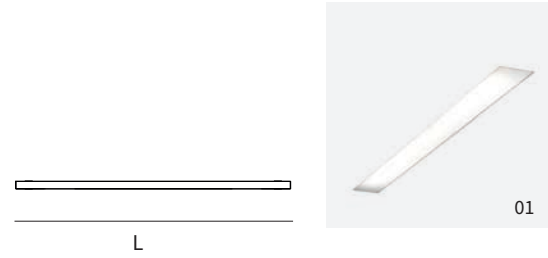

LED 24W/m			lm product:3000K/diffuser		CODE
W	Lmm	Kg	with opal diffuser	with microprismatic	
19,2	860	2.50	1371	1533	F2021.8 ●●●/01
25,6	1140	3.30	1828	2044	F2022.8 ●●●/01
32	1420	4.00	2285	2555	F2023.8 ●●●/01
38,4	1700	4.70	2742	3066	F2024.8 ●●●/01
44,8	1985	5.50	3199	3576	F2025.8 ●●●/01
51,2	2265	6.00	3656	4087	F2026.8 ●●●/01
57,6	2545	6.40	4113	4598	F2027.8 ●●●/01
64	2825	6.90	4570	5109	F2028.8 ●●●/01

LED 32W/m			lm product:3000K/diffuser		CODE
W	Lmm	Kg	with opal diffuser	with microprismatic	
27	860	2.50	1930	2157	F2051.9 ○●●/01
36	1140	3.30	2573	2877	F2052.9 ○●●/01
45	1420	4.00	3216	3596	F2053.9 ○●●/01
54	1700	4.70	3859	4315	F2054.9 ○●●/01
63	1985	5.50	4502	5034	F2055.9 ○●●/01
72	2265	6.00	5146	5754	F2056.9 ○●●/01
81	2545	6.40	5789	6473	F2057.9 ○●●/01
90	2825	6.90	6432	7192	F2058.9 ○●●/01

FILE 2 SOFFITTO
A LUCE DIRETTA E DIFFUSA / DIRECT AND DIFFUSED LIGHT

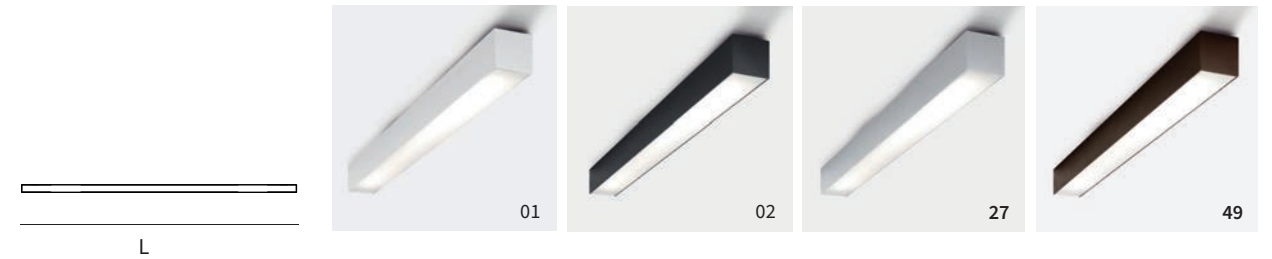

LED 24W/m			lm product:3000K/diffuser		CODE
W	Lmm	Kg	with opal diffuser	with microprismatic	
19,2	860	2.50	1371	1533	F2221.8 ●●●/##
25,6	1140	3.30	1828	2044	F2222.8 ●●●/##
32	1420	4.00	2285	2555	F2223.8 ●●●/##
38,4	1700	4.70	2742	3066	F2224.8 ●●●/##
44,8	1985	5.50	3199	3576	F2225.8 ●●●/##
51,2	2265	6.00	3656	4087	F2226.8 ●●●/##
57,6	2545	6.40	4113	4598	F2227.8 ●●●/##
64	2825	6.90	4570	5109	F2228.8 ●●●/##

LED 32W/m			lm product:3000K/diffuser		CODE
W	Lmm	Kg	with opal diffuser	with microprismatic	
27	860	2.50	1930	2157	F2251.9 ○●●/##
36	1140	3.30	2573	2877	F2252.9 ○●●/##
45	1420	4.00	3216	3596	F2253.9 ○●●/##
54	1700	4.70	3859	4315	F2254.9 ○●●/##
63	1985	5.50	4502	5034	F2255.9 ○●●/##
72	2265	6.00	5146	5754	F2256.9 ○●●/##
81	2545	6.40	5789	6473	F2257.9 ○●●/##
90	2825	6.90	6432	7192	F2258.9 ○●●/##

ACCESSORI / ACCESSORIES

PER INSTALLAZIONE A LATERIZIO / CALCESTRUZZO FOR BRICK WALLS / CONCRETE

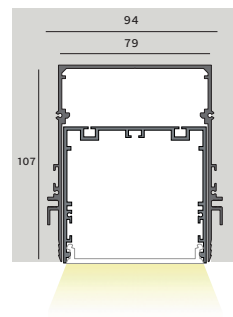

CASSAFORMA "CONTAINER" / WALLBOX "CONTAINER"

Dim:mm	H:mm	L:mm	CODE
79-95	107	1000	LTF2.1000/27
79-95	107	2000	LTF2.2000/27
79-95	107	3000	LTF2.3000/27
79-95	107	----	LTF2.misura/27

COPPIA DI TESTATE PER CASSAFORMA / COUPLE OF CLOSURE HEADS FOR WALLBOX

CODE
LT2890.1

STAFFA SINGOLA PER FISSAGGIO MODULO / MODULE FIXING SINGLE BRACKET

CODE
LT2891

Staffa per fissaggio modulo luminoso all'interno della cassaforma. ordinare 1 al m. (minimo 2 pezzi) | Single bracket to fix the lighting module within the wallbox, order 1 per m. (min. 2 pcs)

info: Vedi la collezione "Container" per scoprire come sviluppare con un unico profilo molteplici soluzioni. | See Container collection to discover how develop different solution with just one profile.

VERSIONI DISPONIBILI/AVAILABLE VERSION

- KELVIN
- KELVIN
- 27 2700K
- 30 3000K
- 40 4000K
- HC Horticulture

● DIFFUSORE/DIFFUSER

P Diffusore in policarbonato bianco opale | White opal polycarbonate diffuser

X Microprismatic *

* Diffusore microprismatico a luminanza controllata (conforme alla normativa EN 12464-1). | Microprismatic diffuser controlled luminance (conform to standard EN 12464-1).

● DIMMABLE (OPTIONAL)

D Dali Touch & Dimm

SU RICHIESTA ON DEMAND

E Versione ad emergenza / Emergency version

D10 Dimmerabile 1-10V / Dimmable 1-10V

CA Sistema di controllo CASAMBI/ CASAMBI control system

/## FINITURA/FINISHING

/01 bianco/white

/27 alluminio anodizzato/anodized aluminium

COMPOSIZIONE CODICE: xxx.x ●●●/##
HOW TO CREATE THE CODE: **F1000.827XD/01**



OUTDOOR

451

ALIMENTATORI
DRIVERS

458

TAGLI A MISURA
CUSTOM CUT

460

GRADO DI PROTEZIONE IP
DEGREE OF PROTECTION

461

LIVELLO DI ILLUMINAMENTO
LIGHTING LEVEL

462

SIMBOLOGIA S
IMBOLOGY

463

SOMMARIO
SUMMARY

ATTENZIONE:

NEL CASO DI INSERIMENTO IN UN FORO ISPEZIONABILE SI PREGA DI PORRE LA NECESSARIA ATTENZIONE ALLE MISURE DELL'ALIMENTATORE: AXB, L E Ø

ATTENTION:

IN CASE OF INSTALLATION IN AN INSPECTABLE HOLE PLEASE PAY ATTENTION TO THE POWER SUPPLY MEASUREMENTS: AXB, L AND Ø

	NOTE	TAGLIO DI FASE TRAILING EDGE	DALI	DALI 2	TOUCH & DIMM	1-10 V	mA	V IN	V OUT RANGE	W	AXB MM	L mm	FORO Ø MM	IP
250	AE250.10	ON-OFF					250	220-240	2,5÷50	10	35x21,5	68	42	20

	NOTE	TAGLIO DI FASE TRAILING EDGE	DALI	DALI 2	TOUCH & DIMM	1-10 V	mA	V IN	V OUT RANGE	W	AXB MM	L mm	FORO Ø MM	IP
350	AE350.8C						350	100÷240	0,5÷25	0,5÷8	35x21,5	68	42	20
	AE350.10C						350	220÷240	17÷29	6÷10	39x20	65	45	20
	AE350.10CD		X				350	220÷240	8,5÷28	3÷10	38x21	94	45	20
	AE350.11C						350	220÷240	2÷31	0,7÷11	37x28	128	48	20
	AE350.15C						350	220÷240	26÷43	9÷15	40,5x22	85	47	20
	AE350.14IP						350	220÷240	3÷40	14	39x19	85	45	67
	AE350.15CD		X				350	220÷240	26÷43	9÷15	40,5x22	85	47	20
	AE350.17	ON-OFF					250	220-240	2,5÷50	10	35x21,5	68	42	20
	AE350.25CD		X				350	220÷240	45÷72	16÷25	38x29	131	50	20
	AE500.20C.MP	to be set at 350mA					250-500	220÷240	30÷42	10,5÷14,5	40,5x22	85	96	20
	AE500.20CD.MP	to be set at 350mA			X	X	250-550	220÷240	3÷45	1÷15,5	40,5x22	116	92	20
	AE700.20C.10V.MP	to be set at 350mA				X	350-900	110÷127 220÷240	43	15	52x22	112	55	20
	AE700.20C.MP	to be set at 350mA					350-700	220÷240	2÷54	0,7÷19	52x22	112	55	20
	AE700.20CD.MP	to be set at 350mA			X		350-700	110÷127 220÷240	2÷54	0,7÷19	52x22	112	55	20
	AE700.30CD.MP	to be set at 350mA				X	350-700	220÷240	27÷44	9,5÷15,5	44x23	98	45	20
	AE700.32C.MP	to be set at 350mA					350-700	220÷240	1÷46	0,5÷16	46x34	166	60	20
	AE700.32C1.MP	to be set at 350mA					350-700	110÷127 220÷240	2÷46	0,7÷16	67x21	103	72	20
	AE700.32CD.MP	to be set at 350mA			X		350-700	110÷127 220÷240	24	0,7÷16	67x21	103	63	20
	AE900.30CD.MP	to be set at 350mA			X	X	350-900	220÷240	9÷58	3,2÷20	67x22	103	72	20
	AE900.36C.MP	to be set at 350mA					150-900	220÷240	2,5÷50	0,9÷17,5	30x21	163	39	20
	AE900.36CD.MP	to be set at 350mA			X	X	150-900	220÷240	2,5÷50	0,9÷17,5	30x21	163	39	20
	AE1050.38CD.MP	to be set at 350mA			X	X	350-1050	220÷240	10÷51	3,5÷18	44x30	147	55	20
	AE1050.38CD2C.MP	to be set at 350mA (2 channels)			X		350-1050	220÷240	20÷50 x ch	17,5 x ch	70x31	215	78	20
	AE1050.50C.MP	to be set at 350mA					350-1050	110÷127 220÷240	2÷74	0,7÷25	79x22	124	84	20
	AE1050.50CD.MP	to be set at 350mA			X	X	350-1050	110÷127 220÷240	2÷74	0,7÷25	79x22	124	84	20

CUSTOM CUTS

How to order profiles, diffusers, shapers or heatsinks in a non-standard linear length or with ends 45°-angle cut.

A) PROFILE, DIFFUSER, SHAPERS, HEATSINK OF A NON-STANDARD LINEAR LENGTH

- choose the "misura /XX" ref. code of the desired product
- replace the word "misura" with the desired length in mm.
- to calculate the price follow the instructions reported on the pricelist.

Example

MINIFILE Ceiling profile white of 2.530 mm. LTM00.misura becomes LTM00.2530

B) PROFILE, DIFFUSER, SHAPERS, HEATSINK WITH ONE OR BOTH ENDS 45°- ANGLE CUT

- choose the "misura /XX" ref. code of the desired product
 - replace the word "misura" with the desired length in mm.
 - Add to the dimension the letters D (right), S (left), L (right/left), Z (left/left), R (right/right) or G (wall/ceiling) according to the desired cut, following the examples hereunder
 - to calculate the price follow the instructions reported on the pricelist.
- Examples (see above)

"L" SHAPED COMPOSITION OF MINIFILE RECESSED PROFILES WHITE, 2.530 X 1.650 MM. AND RELATIVE 45°-ANGLE LEFT AND RIGHT CUTS.

PLAN VIEW FROM ABOVE

"U" SHAPED COMPOSITION OF MINIFILE RECESSED PROFILES WHITE, 2.530 X 1.650 X 2.530 MM. AND RELATIVE 45°-ANGLE LEFT AND RIGHT CUTS

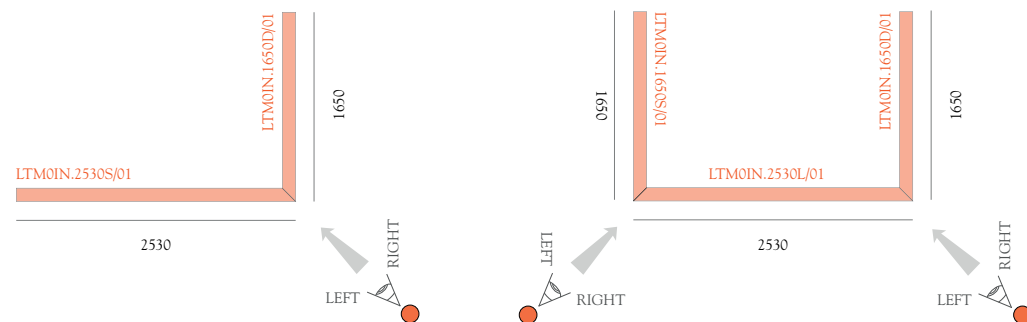

POSITIONING TO DETERMINE LEFT/RIGHT CUT

"Z" shaped composition of MINIFILE Recessed profiles white, 2.530 x 1.650 x 2.530 mm. and relative 45°-angle Left and Right cuts.

"Wall-ceiling" shaped composition of MINIFILE Recessed profiles white, 2.530 x 1.650 mm. and relative 45° angle cuts.

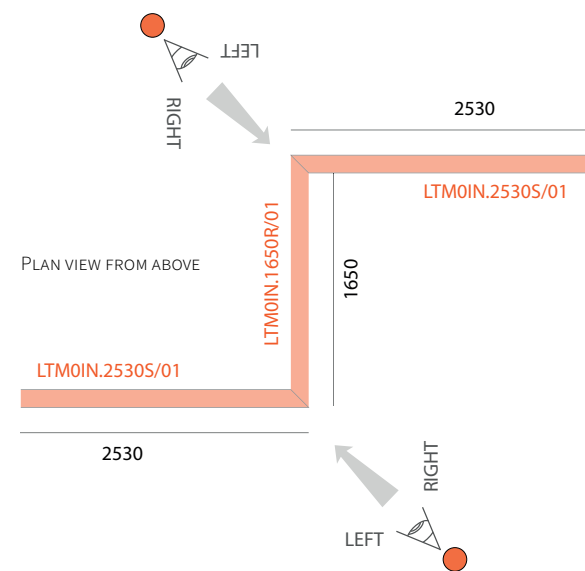

PLAN VIEW FROM ABOVE

POSITIONING TO DETERMINE LEFT/RIGHT CUT

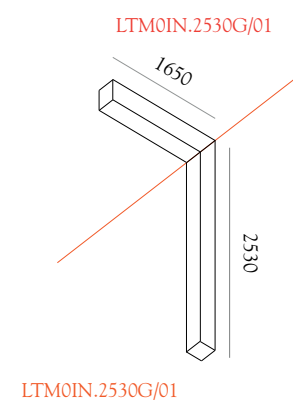

TAGLI A MISURA

Come ordinare profili, diffusori, sagomatori, dissipatori di lunghezza lineare non standard o con l'estremità tagliata a 45°

A) PROFILO, DIFFUSORE, SAGOMATORI, DISSIPATORE DI LUNGHEZZA LINEARE NON STANDARD

- Scegliere il codice ".misura/XX" del prodotto desiderato
 - Sostituire alla parola "misura" la lunghezza desiderata in mm.
 - Calcolare il prezzo seguendo le istruzioni riportate sul listino prezzi
- Esempio:
Profilo MINIFILE Soffitto bianco di lunghezza 2.530 mm. LTM00.misura → diventa LTM00.2350

B) PROFILO, DIFFUSORE, SAGOMATORI, DISSIPATORE CON UNA O DUE ESTREMITA' TAGLIATE A 45°

- Scegliere il codice ".misura/XX" del prodotto desiderato
 - Sostituire alla parola "misura" la lunghezza desiderata in mm.
 - Aggiungere alla misura le lettere D (destra), S (sinistra), L (sinistro/destra), Z (sinistro/sinistro), R (destra/destra) o G (parete/soffitto) a seconda del taglio desiderato, seguendo gli esempi sotto riportati
 - Calcolare il prezzo seguendo le istruzioni riportate sul listino prezzi
- Esempio:

COMPOSIZIONE A "L" DI DUE PROFILI MINIFILE INCASSO BIANCO, 2.530 X 1.650 MM. E RELATIVI TAGLI A 45° SINISTRO E DESTRO.

VISTA IN PIANTA DALL'ALTO

COMPOSIZIONE A "U" DI TRE PROFILI MINIFILE INCASSO BIANCO, 2.530 X 1.650 X 2.530 MM. E RELATIVI TAGLI A 45° SINISTRO E DESTRO.

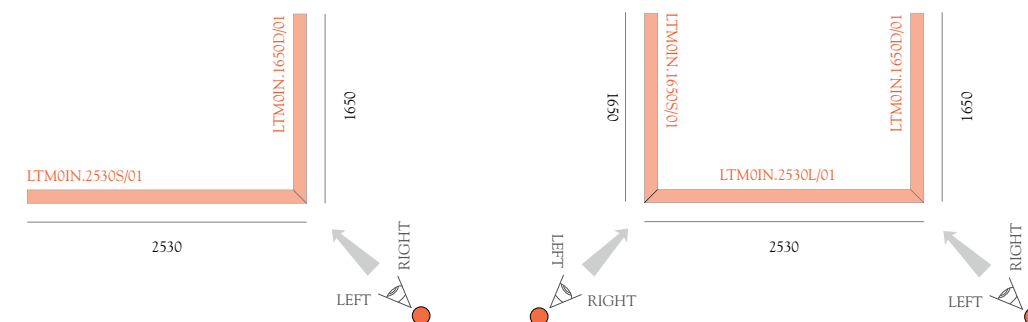

POSIZIONE DELL'OSSERVATORE PER DETERMINARE IL TAGLIO SINISTRO E DESTRO

Composizione a "L" di tre profili MINIFILE Incasso bianco, 2.530 x 1.650 x 2.530 mm. e relativi tagli a 45° Sinistro e Destro.

Composizione a "parete-soffitto" di due profili MINIFILE Incasso bianco, 2.530 x 1.650 mm. e relativi tagli a 45°

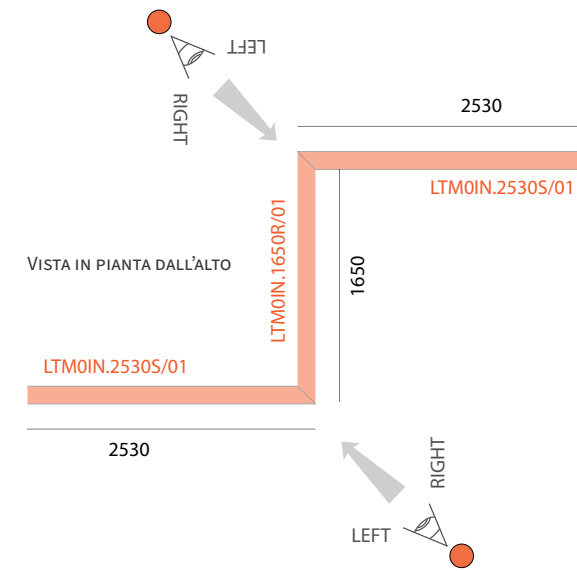

VISTA IN PIANTA DALL'ALTO

POSIZIONE DELL'OSSERVATORE PER DETERMINARE IL TAGLIO SINISTRO E DESTRO

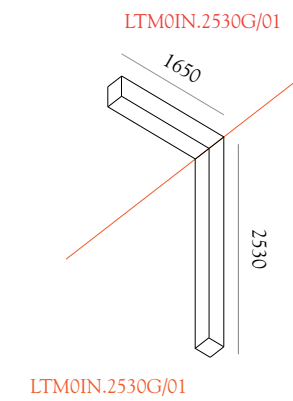

IMPORTANT NOTES

Note: slight colour temperature variations of the LED's sources are to be considered normal (particularly, due to the technical development and to the change of the luminous flux caused by their use, the LED modules delivered subsequently to the first delivery may differ in the luminous flux and light colour). To define the length of the wallboxes with custom length LTMF.misura / LTF1.misura / LTF2.misura: add 3 mm. to the total length of the product going inside the wallbox itself. To define the length of the Container with custom length LTMF.misura / LTF1.misura / LTF2.misura: add 8 mm. to the total length of the product going inside the Container itself. 230V/12V transformer's compatibility with LED lamps. The 230Vac/12Vac transformers presented on this catalogue have been tested with the leading LED lamps manufacturers. Due to the pace of the technological update of them, Lucifero's cannot guarantee their universal compatibility with its transformers. For more info visit our website www.luciferos.it. Max weight of 12V QR-LP 111 LED lamps. The maximum allowed weight of 12V QR-LP 111 LED lamps is of 275 gr.

NOTE IMPORTANTI

Attenzione: leggere variazioni di colore dei LED sono da considerarsi normali (soprattutto in integrazioni di ordini, per il naturale calare dei lumen di quelli usati). Determinazione della lunghezza delle cassaforme a misura LTMF.misura / LTF1.misura / LTF2.misura: aggiungere 3 mm. alla lunghezza totale del prodotto che si intende inserire al suo interno. Determinazione della lunghezza prodotto Container a misura LTMF.misura / LTF1.misura / LTF2.misura: aggiungere 8 mm. alla lunghezza totale del prodotto che si intende inserire al suo interno. Compatibilità trasformatori 230V/12V con lampade LED. I trasformatori 230Vac/12Vac presentati in questo catalogo sono testati con i principali produttori di lampade LED. A causa della velocità dell'adeguamento tecnologico di queste ultime, Lucifero's non può garantire una compatibilità universale delle stesse con i propri trasformatori. Per maggiori informazioni consultare il sito www.luciferos.it. Peso max. lampade QR-LP 111 LED 12V. Il peso massimo consentito delle lampade LED QR-LP 111 sui nostri proiettori è di 275 gr.

GRADI DI PROTEZIONE IP DEGREE OF PROTECTION IP

Lettere IP (protezione internazionale) IP references (international Protection)

Prima parte First part 0-6

Seconda parte Second part 0-8

Terza parte Third part A, B, C o D

Quarta parte Fourth part F, H, M, S, W

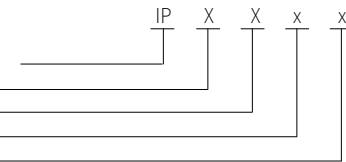

La norma europea EN 60529/1997 e la norma tedesca DIN 40050 Parte 9 costituiscono, in combinazione, un documento esaustivo per quel che riguarda i gradi di protezione degli involucri. L'obiettivo di queste norme è quello di: 1) Definire i gradi di protezione degli involucri per apparecchiature elettriche in relazione a: a) Protezione di persone contro il contatto con parti pericolose all'interno degli involucri; b) Protezione delle apparecchiature contenute negli involucri contro l'ingresso di corpi solidi; c) Protezione delle apparecchiature contenute negli involucri contro l'ingresso dannoso dell'acqua. 2) Designare e classificare i gradi di protezione. 3) Stabilire i requisiti per ciascuna designazione. 4) Definire le prove di verifica. Queste norme classificano i gradi di protezione degli involucri attraverso il codice IP. Il codice IP (International Protection oppure Ingress Protection) è costituito da 4 parti caratteristiche che identificano e caratterizzano il grado di protezione di un involucro.

The European EN 60529 standard and the German DIN 40050 standard, part 9, are, combined, an exhaustive document as concerns the degrees of protection provided by enclosures. The object of this standard is to give: 1) Definitions for the degrees of protection provided by enclosures for electrical equipment as regards: a) Protection of persons against contact with hazardous parts inside the enclosures; b) Protection of the equipment inside the enclosures against ingress of solid foreign objects; c) Protection of the equipment inside the enclosures against the harmful effects due to the ingress of water. 2) Designations and classification for the degrees of protection. 3) Requirements for each designation. 4) Tests to be performed. These Standards classify the degree of protection of the enclosures with the IP code. The IP code (International Protection or Ingress Protection) is made by 4 parts which identify and characterize the degree of protection provided by the enclosure.

Prima parte, indica la protezione dell'individuo contro la penetrazione di corpi solidi e contro l'accesso anche attraverso attrezzi impugnati da una persona. | *First part indicates the protection of the equipment against the ingress of solid foreign objects and the protection against access to hazardous parts also by means of tools in the hands of a person.*

P0_	Non protetto. <i>Non-protected.</i>
IP1_	Protetto contro corpi solidi di diametro ≥ 50 mm. <i>Protected against solid foreign objects ≥ 50 mm in diameter.</i> Protetto contro l'accesso col dorso della mano. <i>Protected against access with the back of hand.</i>
IP2_	Protetto contro corpi solidi di diametro $\geq 12,5$ mm. <i>Protected against solid foreign objects $\geq 12,5$ mm in diameter.</i> Protetto contro l'accesso con un dito. <i>Protected against access with a finger.</i>
IP3_	Protetto contro corpi solidi di diametro $\geq 2,5$ mm. <i>Protected against solid foreign objects $\geq 2,5$ mm in diameter.</i> Protetto contro l'accesso con un utensile, per esempio un cacciavite. <i>Protected against access with a tool, for instance with a screwdriver.</i>
IP4_	Protetto contro corpi solidi di diametro ≥ 1 mm. <i>Protected against solid foreign objects ≥ 1 mm in diameter.</i> Protetto contro l'accesso con un filo. <i>Protected against access with a wire.</i>
IP5_	Protetto parzialmente contro la polvere. La penetrazione non è totalmente esclusa, ma essa non deve inficiare il buon funzionamento dell'apparecchiatura o pregiudicarne la sicurezza. <i>Partially dust-protected. Ingress of dust is not totally prevented, but the dust must not enter in sufficient quantity to interfere with satisfactory operation of the equipment or compromise its safety.</i> Protetto parzialmente contro l'accesso di polvere o di un filo sottile. <i>Ingress of dust is not totally prevented, protected against access with a thin wire.</i>
IP6_	Protetto totalmente contro la polvere. <i>Dust-tight. Protection against ingress of dust.</i> Totalmente protetto dalla polvere. <i>No ingress of dust, complete protection against contact (dust tight).</i>

Seconda parte, indica il grado di protezione contro gli effetti dannosi sull'apparecchiatura dovuti alla penetrazione di acqua nell'involucro. Se non è prevista protezione contro l'ingresso di acqua la cifra deve essere sostituita dalla lettera X. Questa parte può essere costituita da livelli aggiuntivi presenti nella norma DIN 40050-9. | *Second part indicates the degree of protection against the harmful effects due to the ingress of water inside the enclosure. If a protection against the ingress of water is not foreseen, the characteristic numeral must be replaced by letter X. This part may consist of additional levels contained in the DIN 40050-9 standard.*

IP_0	Non protetto. <i>Non-protected.</i>
IP_1	Protetto contro la caduta verticale di gocce d'acqua. <i>Protected against the vertical water dripping</i>
IP_2	Protetto contro la caduta verticale di gocce d'acqua con inclinazione dell'involucro fino a 15°. <i>Protected against the water dripping when the enclosure is tilted at an angle up to 15°.</i>
IP_3	Protetto contro la pioggia (con inclinazione dell'involucro fino a 60°). <i>Protected against rain (enclosure tilted up to 60°).</i>
IP_4	Protetto contro gli spruzzi d'acqua (acqua spruzzata da tutte le direzioni). <i>Protected against spraying (water sprayed from any direction).</i>
IP_5	Protetto contro i getti d'acqua (da tutte le direzioni). <i>Protected against water jets (from any direction).</i>
IP_6	Protetto contro i getti d'acqua potenti (da tutte le direzioni). <i>Protected against powerful water jets (from any direction).</i>
IP_7	Protetto contro gli effetti dell'immersione temporanea (fino a 1 m). <i>Protected against the effects of temporary immersion (up to 1 m).</i>
IP_8	Protetto contro gli effetti dell'immersione continua (oltre 1 m). <i>Protected against the effects of continuous immersion (beyond 1 m).</i>

Terza parte, è la prima lettera aggiuntiva ed indica il grado di protezione contro l'accesso umano a parti pericolose. Essa viene utilizzata nel caso in cui la protezione contro l'accesso a parti pericolose da parte delle persone è effettivamente superiore a quella indicata dalla prima parte, quando quindi non vi è corrispondenza tra il grado di protezione delle persone contro l'accesso a parti pericolose e il grado di protezione contro l'ingresso di corpi solidi estranei; oppure quando non è indicato il grado di protezione contro l'ingresso di corpi solidi (quindi la prima parte è sostituita da una X) ma solo il grado di protezione contro l'accesso umano.

Third part is the first additional letter and indicates the degree of protection for persons against the access to hazardous parts. It is used when the protection for persons against access to hazardous parts is higher than the one indicated by the first part, usually when there is no coincidence between the degree of protection for persons and the degree of protection against the ingress of solid foreign objects; when the degree of protection against solid foreign objects is not indicated (the first part is replaced by a X), but only the degree of protection for persons.

a	Protetto contro l'accesso col dorso della mano. <i>Protected against access with the back of hand.</i>
b	Protetto contro l'accesso con un dito. <i>Protected against access with a finger.</i>
c	Protetto contro l'accesso con un utensile, per esempio un cacciavite. <i>Protected against access with a tool, for instance with a screwdriver.</i>
d	Protetto contro l'accesso con un filo. <i>Protected against access with a wire.</i>

Quarta parte, dopo la seconda cifra caratteristica o dopo la lettera supplementare, può essere presente una lettera aggiuntiva che fornisce informazioni ulteriori sulla protezione del materiale. *Fourth part, after the second part or after the supplementary letter, an additional letter can be appended to provide further information related to the protection of the device.*

F	Resistente agli olii. <i>Oil resistant.</i>
H	Apparecchiatura ad alta tensione. <i>High-voltage equipment.</i>
M	Provato contro gli effetti dannosi dovuti all'ingresso di acqua quando le sue parti sono in movimento. <i>Tested against the harmful effects due to the ingress of water when its movable parts are in motion.</i>
S	Provato contro gli effetti dannosi dovuti all'ingresso di acqua quando le sue parti non sono in movimento. <i>Tested against the harmful effects due to the ingress of water when its movable parts are not in motion.</i>
W	Adatto all'uso in condizioni atmosferiche specifiche e dotato di misure o procedimenti protettivi addizionali. <i>Suitable for use under specific atmospheric conditions and provided with additional protective measures or proceedings.</i>

LIVELLO DI ILLUMINAMENTO - LIGHTING LEVEL UNI 10380/A1

	AMBIENTI MEDICI: 500→750→1000 CAMERE DI DEGENZA, SALE OPERATORIE, AMBULATORI, PRONTO SOCCORSO, CORSIE, CAMERE ASETTICHE	<i>Medical space: 500→750→1000 medical rooms, operating rooms, outpatient wards, emergency treatment rooms, wards, aseptic rooms</i>
	SCUOLE: 300→500→750 AULE, LOCALI DIDATTICI, LABORATORI, SALE RIUNIONI	<i>School: 300→500→750 Classrooms, lab and artistic activity-zones, meeting rooms.</i>
	UFFICI CON VIDEOTERMINALI: 200→300→500 CON ATTIVITÀ A VIDEO SUPERIORE ALLE 6 ORE CONTINUATIVE	<i>Offices with videoterminals: 200→300→500 with video work more than 6 hours</i>
	OPEN SPACE: 200→300→500 UFFICI, GRANDI AREE, AMBIENTI PUBBLICI, SALE D'ATTESA	<i>Open spaces: 200→300→500 offices, big areas, public spaces, waiting rooms</i>
	ARTE E CULTURA: 150→200→300 CINEMA, TEATRI, MUSEI, GALLERIE, CHIESE, BIBLIOTECHE, AUDITORI, MONUMENTI	<i>Art and culture: 150→200→300 cinemas, theatres, museums, galleries, churches, libraries, auditoriums, monuments</i>
	AMBIENTI COMUNI: 150→200→300 CORRIDOI, GIRO SCALE, ASCENSORI	<i>Share spaces: 150→200→300 corridors, stairs, lifts</i>
	CENTRI COMMERCIALI: 500→750→1000 NEGOZI IN GENERE, SALE ESPOSIZIONI, VETRINE, SUPERMERCATI, AEROPORTI, FACCIATE DI NEGOZI	<i>Shopping centres: 500→750→1000 shops in general, showrooms, shop windows, supermarkets, airports, shop fronts</i>
	LOCALI SECONDARI: 150→200→300 SALE MACCHINE, CANTINE, GUARDAROBA, DEPOSITI, BOX, SPOGLIATOI, CUCINE, BAGNI	<i>Secondary spaces: 150→200→300 Cellars, workshops, cloakrooms, deposits, boxes, bathrooms, kitchens, dressingrooms.</i>
	LOCALI GENERALI: 150→200→300 ABITAZIONI, ALBERGHI, CAMERE	<i>General spaces: 150→200→300 residential areas, hotels, rooms</i>
	INDUSTRIE ALIMENTARI: 200→300→500	<i>Food industries: 200→300→500</i>
	RISTORANTI, BAR, MENSE: 150→200→300	<i>Restaurants, bars: 150→200→300</i>
	UFFICI TECNICI: 500→750→1000	<i>Technical offices: 500→750→1000</i>

LTN70K.9	81	MM012.9	213	PP165.9	237
LTN80K.9	85	MM015.9	213	PP166.9	237
LTN88K.9	385	MM016.9	213	PP167.9	237
LTN88K.9	77	MN000.9	276	PP221.9	239
LTN89K.9	386	MN000.9	419	PP321.9	239
LTN89K.9	80	MN001.9	276	PP421.9	433
LTN90.9	85	MN001.9	419	PP422	433
LTS01	330	MN002.9	276	PP521.9	431
LTS01	333	MN002.9	419	PP621.9	431
LTS03	330	MN003.9	276	PPQ10	227
LTS04	333	MN003.9	418	PPQ11	227
LV001A	110	MN004.9	276	PPQ12	227
LV001A	438	MN004.9	418	PPQ20	227
LV001F	110	MN005.9	276	R18FH0.9	253
LV001F	438	MN005.9	418	R18FH1.9	253
LV001K.9	110	MN006.9	277	R18FH2.9	253
LV001P.9	438	MN006.9	419	R18FH3.9	253
LV003A	110	MN007.9	277	R18FH4.9	253
LV003A	438	MN007.9	419	R18FH5.9	253
LV003B	114	MS10.9	126	R18FH6.9	253
LV003F	110	MS12	126	R18FH7.9	253
LV003F	438	MS20.9	126	R18FH8.9	253
LV003K.9	110	MS22	126	R18FM0.8**	253
LV003P.9	438	MS30.9	126	R18FM1.8	253
LV005A	111	MS32	126	R18FM2.8	253
LV005A	439	MS40.9	126	R18FM3.8	253
LV005B	114	MS42	126	R18FM4.8	253
LV005C	115	MS50.9	124	R18FM5.8	253
LV005F	111	MS52	124	R18FM6.8	253
LV005F	439	MS60.9	124	SE501.9	193
LV005K.9	111	MS62	124	SE502.9	193
LV005P.9	439	MS70.9	125	SE503.9	193
LV010A	111	MS72	125	SE505.9	193
LV010B	114	MS80.9	125	SK000.9	61
LV010F	111	MS82	125	SK000.1000	337
LV010K.9	111	MSC01	127	SK000.2000	337
LV015A/01	111	MSC01	139	SK000.3000	337
LV015F	111	MSC02	127	SK000.misura	337
LV015K.9	111	MSC02	139	SK000TP	337
LV021.9	264	MSC03	127	SK000TP	337
LV021P.9	443	MSC03	139	SK010.9	61
LV026.9	264	MSC04	127	SO026.9 F	65
LV026P.9	443	MSC11	124	SO036.9 65	
LV027.9	265	MSC11	138	ST05.	253
LV027P.9	443	MSC12	124	ST05.	321
LV028.9	265	MSC12	138	ST10.	253
LV028P.9	443	MSC13	125	ST10.	321
LV029.9	265	MSC13	138	ST10.IP	253
LV041K.9	114	MSC14	125	ST10.IP	321
LV042K.9	114	MSC21	124	ST10.IP	331
LV043K.9	114	MSC21	138	ST10.IP	333
LV044K.9	115	MSC22	124	ST10.IP	337
LV051K.9	115	MSC22	138	ST11.	253
LV083.9	265	MSC23	125	ST11.	321
LV084.9	265	MSC23	138	ST18.IP	253
LV115B	115	MSC24	125	ST18.IP	321
LV205A/01	112	NF010.9	87	ST18.IP	331
LV205F	112	NF010.9 F	389	ST18.IP	333
LV205K.9	112	NF015.9	89	ST18.IP	337
LV210A/01	112	NF023.9	87	ST19.RGBW.5	253
LV210F	112	NF023.9	389	ST19.RGBW.5	321
LV210K.9	112	NF024.9	87	ST19.RGBW.5IP	253
LV220.9	299	NF024.9	389	ST19.RGBW.5IP	321
LV301F	113	NF028	87	ST19.RGBW.5IP	331
LV301F	442	NF028	389	ST19.RGBW.5IP	333
LV301M	113	NF031.9	89	ST19.RGBW.5IP	337
LV301M	442	NF033.9	89	ST20.RGBW.5	253
LV302F	113	NF038	89	ST20.RGBW.5	321
LV302F	442	NF040.9	87	ST22.	253
LV302M	113	NF040.9	389	ST22.	321
LV302M	442	NF050.9	89	ST22.27.5	204
LV312.9	175	NF060.9	87	ST22.30.5	204
LV316.9	175	NF060.9	389	ST22.40.5	204
LV321	300	NF070.9	89	ST22.TW.5	253
LV321A	300	NN01.505	399	ST22.TW.5	321
LV325.9	300	NN01.1005	399	TEIN01M	132
LV325A.9	300	NN01.2005	399	TEIN01M	144
LV333.9	175	NN01.3005	399	TEIN02M	132
LV351K.9	113	NN02	399	TEIN02M	144
LV351K.9	442	NN03	399	TEIN03M	132
LV352K.9	113	NN04	399	TEIN03M	144
LV352K.9	442	NN05.8	399	TRAS/70D	453
LV410.9	175	NN05.8 misura	399	TW001	98
LV411.9	175	NN08	399	TW100.9 W	98
LV705P.9	441	PH152.9	197	TW101.9 W	98
LV706P.9	441	PH155.9	197	TW102.9	98
LV707P.9	441	PH156.9	197	TW103.9	98
LV708P.9	441	PP00P	233	TW104.9	98
LVKITS	115	PP001.9	233	TW105.9	98
MF00P.1000	203	PP001.9	305	TW112.9	98
MF00P.2000	203	PP005.9	305	TW113.9	98
MF00P.3000	203	PP005L.9	306	TW114.9	99
MF00P.misura	203	PP006.9	305	TW115.9	99
MF101.8	297	PP006L.9	307	TW116.9	99
MF102.8	297	PP007.9	311	TW117.9	99
MF103.8	297	PP008.9	311	TW210.9 W	100
MF111.8	297	PP009.9	311	TW211.9 W	100
MF112.8	297	PP013	237	TW212.9	100
MF113.8	297	PP013.9	237	TW213.9	100
MF201.8	297	PP014.9	237	TW214.9	100
MF202.8	297	PP021.9	237	TW215.9	100
MF203.8	297	PP022.9	237	TW220.9	100
MF211.8	297	PP023	237	TW221.9	100
MF212.8	297	PP040	429	TW224.9	100
MF213.8	297	PP040.9	309	TW225.9	101
MF301.8	297	PP041	429	TW226.9	101
MF302.8	297	PP041.9	309	TW227.9	101
MF303.8	297	PP042.9	309	VT / IN45.90	149
MF304.8	297	PP112.9	235	VT / IN92	149
MF311.8	297	PP113	235	WI001.9 / 01	161
MF312.8	297	PP116.9	305	WI011.9 / 01	161
MF313.8	297	PP116L.9	306	WI101.9 / 01	161
MF314.8	297	PP117.9	305	WI111.9 / 01	161
MFH00.1000/01	203	PP117L.9	306		
MFH00.2000/01	203	PP119.9	305		
MFH00.3000/01	203	PP119L.9	307		
MFH00C/01	203	PP120.9	305		
MFH00.misura/01	203	PP120L.9	307		
MM001.9	212	PP121.9	235		
MM002.9	212	PP122.9	235		
MM003.9	212	PP123	235		
MM004.9	212	PP151.9	235		
MM005.9	212	PP152.9	235		
MM006.9	212	PP155.9	235		
MM007.9	212	PP156.9	235		
MM008.9	212	PP157.9	235		
MM011.9	213	PP161.9	237		